

# QST

devoted entirely to

# amateur radio

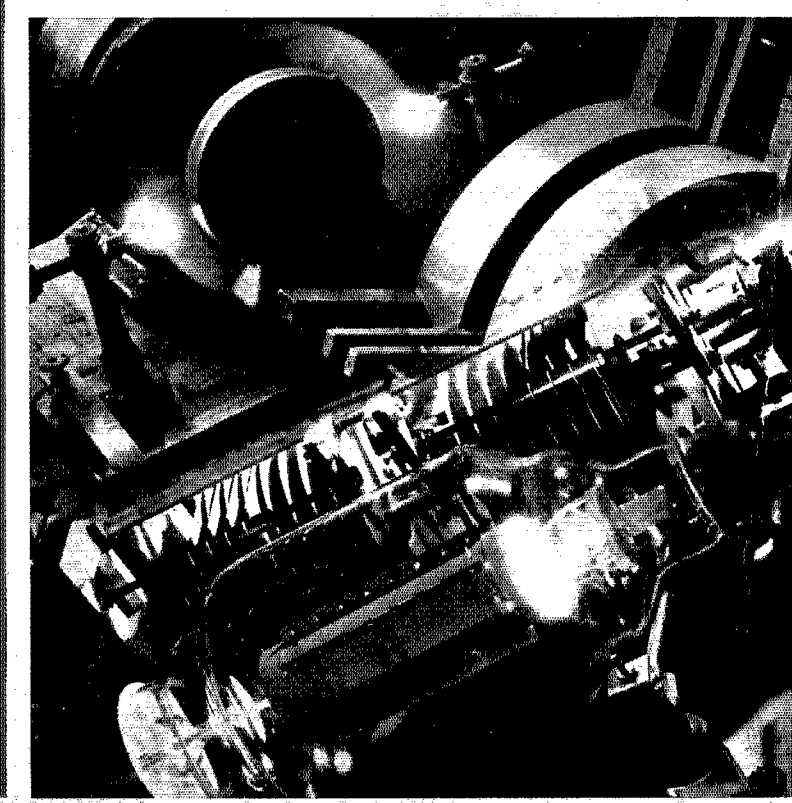

may  
1934  
25 cents

# THE RADIO AMATEUR'S HANDBOOK



The Radio Amateur's Handbook is the standard guide to Amateur Radio. Here is what it contains: Chapter I outlines the story of Amateur Radio — its start, its difficulties, its accomplishments; of the formation of the League to protect and preserve the rights of amateurs. Chapter II explains in detail how to get started in this finest of hobbies. Chapters III & IV, in simple language, explain electrical and radio fundamentals. Chapter V is devoted entirely to receivers. It contains circuits with complete constructional details and makes comparisons of the various circuits. It is full of constructional tips. Chapter VI recognizes monitors and frequency meters as essential parts of the equipment and tells how to make various types; how to calibrate them, and how to use them properly. Chapter VII covers transmitters, the most important part of a station. Self-excited and crystal-controlled; what ones to build, how to build them, how to tune them, and countless other helpful things, are all here. Chapter VIII, headed "Radio-telephony," covers the particular problems of 'phone transmitters and their operation, thoroughly and completely. Different types of modulators and amplifiers are shown and attention called to their various advantages. Chapter IX, written by pioneers in the Ultra-high Frequency field, points out the unusual circumstances to be found and gives the necessary information to build complete transmitters and receivers for use on frequencies of 30 megacycles and up. Chapter X treats of the vital subject of power supplies. Largely upon your power supply, depends the quality of your note. Here you will find power supplies designed especially to meet your particular needs. Chapter XI tells you how to prevent and cure various types of interference. It considers broadcast reception interference, and suggests the best keying methods. Chapter XII, on antennas, is packed with useful suggestions of how to best meet this frequently bothersome problem. The best of transmitters cannot make up for a poor antenna. The solution to your antenna difficulties will be found in these pages. Chapter XIII suggests various station arrangements both for the fellow who has plenty of room and the fellow whose space is limited. Chapter XIV explains the workings of the League's Communications Department. It tells of its aims and purposes; of its extensive field organization and how you may take part in all its activities. Chapter XV gives full instructions on the best operating procedure. From the calling of a station to the keeping of a log, it is all covered. Chapter XVI tells how messages should be handled, the correct form, and the restrictions governing message handling. In addition to these chapters there is an appendix full of useful data such as international prefixes, list of "Q" signals, commonly used abbreviations, and many useful charts and tables. In wealth of information (260 pages) and its 224 illustrations, the **HANDBOOK** is a big, valuable book. Price postpaid, \$1.00 in paper cover — \$2.00 in stiff maroon buckram binding.



**AMERICAN RADIO RELAY LEAGUE, INC.**  
WEST HARTFORD, CONNECTICUT

# For Every TUBE and PURPOSE

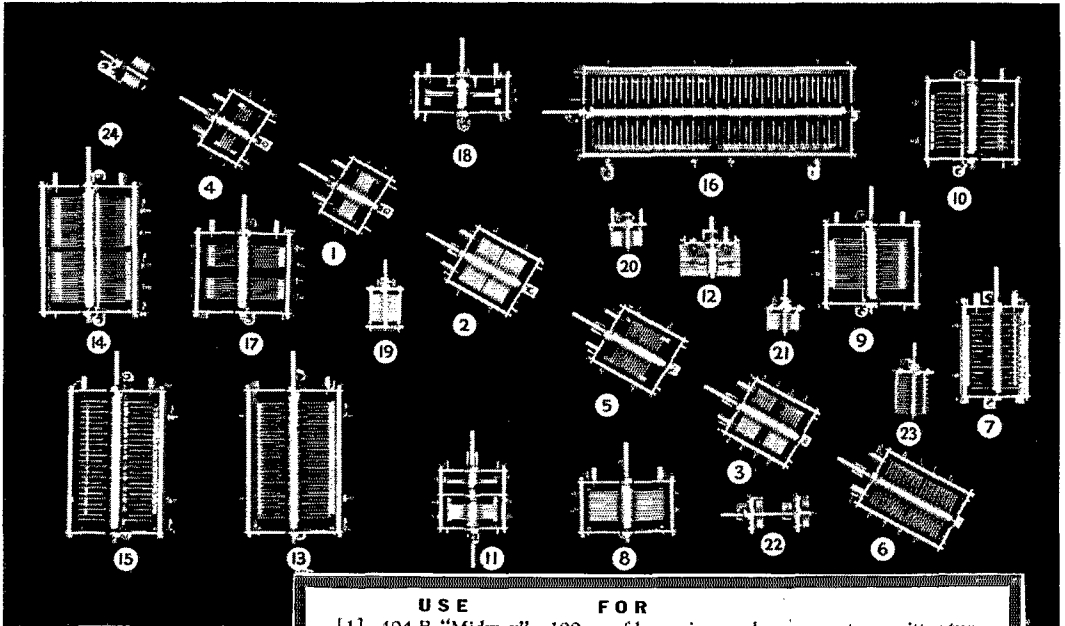

## FOR HIGH POWERED TRANSMITTERS —

CARDWELL Construction Designs 166-B, 166-B, and 16-B are giving faithful service in hundreds of broadcasting and commercial stations.

## IN TUBE BOMBARDERS

CARDWELL fixed, oil dielectric condensers are insuring uninterrupted production of receiving and transmitting tubes, with no costly shut-downs for condenser replacements.

*There are many more CARDWELLS Send for Literature*

**The ALLEN D. CARDWELL MFG. CORP'N.**

83 PROSPECT STREET  
BROOKLYN, N. Y.

## USE FOR

- [1] 404-B "Midway"—100 mmfd. receiver or low-power transmitter tuning condenser.
- [2] 407-B (Split) "Midway"—150 mmfd. per section. Use for C1 (Portable 56 mc fone) Page 131, 11th edition of ARRL "Handbook".
- [3] 405-C (Double) "Midway"—ditto, also suitable for S. W. receivers.
- [4] 409-B (Double) "Midway"—35 mmfd., 3000v. suitable for neutralizing 211's and 203-A's non-modulated.
- [5] 411-B (Double) "Midway"—70 mmfd.—general purpose—medium-power transmitters.
- [6] 413-B (Split) "Midway"—70 mmfd. per section. High frequency push-pull amplifier tank circuit.
- [7] 415-B (Split) "Midway"—34 mmfd. 6000 v. Especially designed for neutralizing 50 watt modulated stages.
- [8] 123-B "Standard"—Very popular for low-power transmitters.
- [9] 164-B "Standard"—220 mmfd. 3000 v. The most economical medium-power quality transmitting condenser on the market.
- [10] 513-B "Standard"—Neutralizer for 204-A's non-modulated.
- [11] 518 "Standard"—Bandspread for receivers and monitors (various capacity combinations).
- [12] 519 "Standard"—Neutralizer for RK 18, 800, 852 and 825 tubes.
- [13] 520-B "Standard"—250 mmfd. 4500 v. Tank tuning condenser up to and including 852's non-modulated.
- [14] 157-B "Standard"—For tuning 100 watt, push-pull amplifiers, also ideal for Grammer's fixed neutralizing as applied to 100 watt tube. Also C7 in popular 3 tube transmitter by Grammer, February QST. Also C1 Page 129 (11th edition ARRL Handbook) 56 mc oscillator.
- [15] T-183 "Standard"—110 mmfd. 6000 v. suitable for 852 modulated amplifier.
- [16] DT-183 "Standard"—110 mmfd. per section. For push-pull, 852's etc.
- [17] 197-B "Standard"—80 mmfd. per section. For push-pull, medium-power, low C circuits.
- [18] 201-E "Standard"—Adjustable stator, SLF tuning condenser.
- [19] RT-140 "Trim Air"—High frequency receiving "TRIM AIR" Midget.
- [20] RT-75 "Trim Air"—High frequency receiving "TRIM AIR" Midget.
- [21] RT-50 "Trim Air"—Excellent for neutralizing '10 tubes.
- [22] RT-15 "Trim Air"—Showing how "TRIM AIRS" may be ganged.
- [23] XT-30 "Trim Air"—Neutralizing 830's and '10's (can be ganged for push-pull 56 mc oscillators).
- [24] 613-A "Trim Air"—50 mmfd. "Balancer" suitable for neutralizing '10's.

"THE STANDARD of COMPARISON"

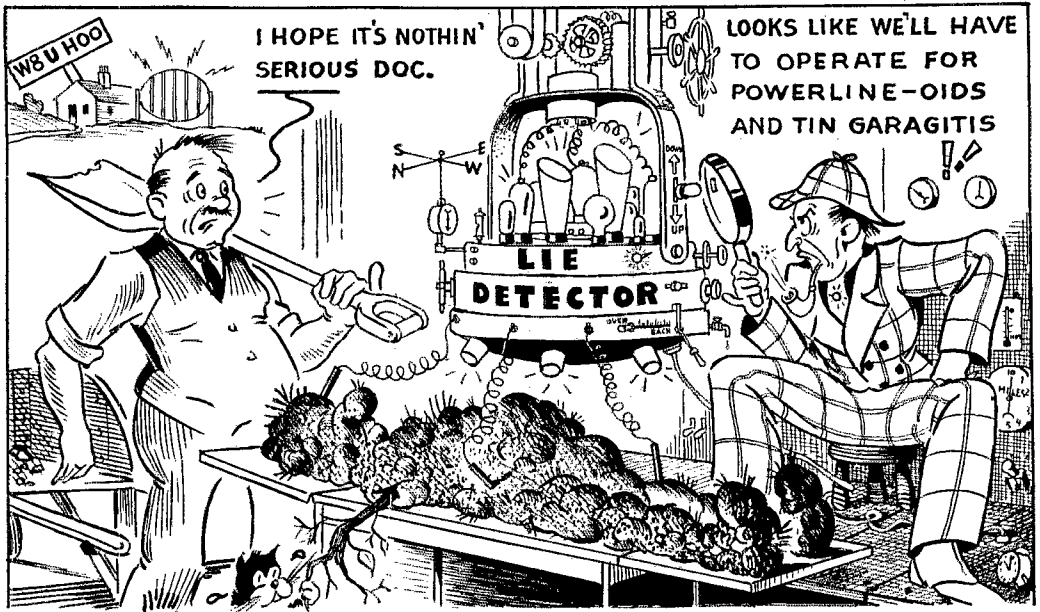

# Give your FIELD FORM a PHYSICAL EXAM with Westinghouse Instruments

**WOULD** you like to know which way your sigs jump when you push the key? Why your neighbor's new wire fence wrecked your South African dx? What happened when the wash was hung on the counterpoise? The effectiveness of that new trick antenna? If the 5-meter parabolic "Signal Squirter" is doing its stuff?

For full information on how to build and operate a simple, low-cost field strength measurement set that will answer these questions, get the new Westinghouse Folder, 8336, hot off the press. It gives in full the circuit, constructional details, layout, and conversion charts of a self-calibrating field strength measurement set that doesn't weigh a ton, and is within the ham's purchasing power.

Westinghouse has given the amateurs considerable data on radiating systems in Folder 8322 on "Untuned Transmission Lines," Folder 8327 on "Directional Antennae," and

Folder 8329 on "The Angle of Radiation." Now, in addition to the theoretical dope that will help you radiate more efficiently, with the new field strength set, you can turn theory into practice and *know* what you're doing.

The set uses Westinghouse instruments, and that means that with proper care in construction it will maintain a high degree of accuracy over an extremely long life.

Send the coupon or a post card for your copy of the new folder, or any of those on radiating systems that you've missed. Be sure that you have our catalog on MX and NX instruments.

## SEND FOR INFORMATION

Westinghouse Electric & Manufacturing Company  
Dept. 128, Room 2-N East Pittsburgh, Pa.

Gentlemen:

Please send me the booklets checked below:

- F. 8336—Field Strength Measurement Set.
- Catalog 43-340—Types MX and NX Instruments.
- Other Folders.....

Name .....

Address .....

City.....State.....QST 5-34

Call Letters..... T 79985

# Westinghouse

Quality workmanship  
guarantees every Westinghouse product





# QST

Published monthly, as its official organ, by the American Radio Relay League, Inc., at West Hartford, Conn., U. S. A.; Official Organ of the International Amateur Radio Union

devoted entirely to

# AMATEUR RADIO

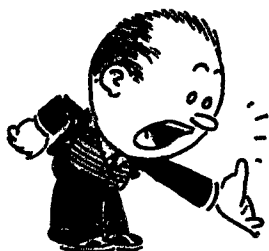

Hiram Percy Maxim . . . . .	Frontispiece
Editorials . . . . .	9
Some Anniversary Greetings . . . . .	10
Twenty Years of Amateur Radio . . . . .	20
A Sketch of Technical Progress . . . . .	27
Two Decades of Progress in Amateur Station Equipment . . . . .	28
Hamdom's Traditions . . . . . Rufus P. Turner, W1AY	32
Amateur Radio Marches On! . . . . .	33
Suppressor-Grid Modulation in the Low-Power 160-Meter 'Phone . . . . .	34
. . . . . D. H. Mix, W1TS	
A DeLuxe Crystal Type S.S. Receiver . . . . . LeRoy Moffett, Jr., W9IJ	40
Completing the Three-Stage Transmitter . . . . . George Grammer	46
Hamdom . . . . .	52
Regeneration in the Tuned R. F. Stage . . . . .	53
. . . . . Walter Sullivan, W6CGR and Fred Kienle, W6FMG	
Greatest DX Contest Ever Staged . . . . .	56
A 500-Watt Transmitter in the Modern Manner . . . . .	59
. . . . . Albert H. Jackson, W1NI	
The Regenerative S.S. Receiver Brought Up to Date . . . . .	64
. . . . . R. W. Woodward, W1EAO	
High-Q Tank Circuits for Ultra-High Frequencies . . . . .	69
. . . . . Frederick A. Kolster	
A New Pentode-Type Screen-Grid Transmitting Tube . . . . .	71
. . . . . James J. Lamb	
Communications Department . . . . .	73
A.R.R.L. A-1 Operator Club . . . . .	88
Fourth All-Section Sweepstakes Contest Results . . . . . E. L. Battey	90
I. A. R. U. News . . . . .	95
Correspondence Department . . . . .	96
New Canadian 'Phone Regs. . . . .	98
Standard Frequency Transmissions . . . . .	100
Visit the Clubs . . . . .	108
Hudson Division Convention . . . . . Announcement	114
Washington Notes . . . . .	136
Hamads . . . . .	138
QST's Index of Advertisers . . . . .	142

MAY  
1934

VOLUME XVIII  
NUMBER 5

Kenneth B. Warner (Secretary, A.R.R.L.), Editor-in-Chief and Business Manager; Ross A. Hull, Associate Editor; James J. Lamb, Technical Editor; George Grammer, Assistant Technical Editor; Clark C. Rodimon, Managing Editor; David H. Houghton, Circulation Manager; F. Cheyney Beekley, Advertising Manager; Ursula M. Chamberlain, Assistant Advertising Manager.

Editorial and Advertising Offices  
38 La Salle Road, West Hartford, Conn.

Subscription rate in United States and Possessions and Canada, \$2.50 per year, postpaid; in other countries, \$3.00 per year, postpaid. Single copies, 25 cents. Foreign remittances should be by international postal or express money order or bank draft negotiable in the U. S. and for an equivalent amount in U. S. funds.

Entered as second-class matter May 29, 1919, at the post office at Hartford, Connecticut, under the Act of March 3, 1879. Acceptance for mailing at special rate of postage provided for in section 1103, Act of October 3, 1917, authorized September 9, 1922. Additional entry at Concord, N. H., authorized February 21, 1929, under the Act of February 28, 1925.

Copyright 1934 by the American Radio Relay League, Inc.  
Title registered at United States Patent Office.



**BLACK AND WHITE**

*Stripes*

**THE HALLMARK OF BATTERY QUALITY**

**FOR TWENTY-FIVE YEARS** the BURGESS Laboratories have been developing better batteries. Today BURGESS sets the standard of battery quality. Only in BURGESS Batteries will you find the pure materials (seamless zinc containers 99-98/100% pure!), the advanced construction and the patented chrome preservative which give your batteries longer life and greater recuperative power. ● Experience has taught thousands of battery users, radio amateurs particularly, that the BURGESS laboratory control over materials and production methods has resulted in batteries of outstanding performance. It pays to look for the BLACK and WHITE Stripes when buying batteries. They are the hall-mark of battery quality. Burgess Battery Company, Freeport, Illinois.

**BURGESS**

Say You Saw It in QST -- It Identifies You and Helps QST



• **T**HE AMERICAN RADIO RELAY LEAGUE, INC., is a non-commercial association of radio amateurs, bonded for the promotion of interest in amateur radio communication and experimentation, for the relaying of messages by radio, for the advancement of the radio art and of the public welfare, for the representation of the radio amateur in legislative matters, and for the maintenance of fraternalism and a high standard of conduct.

It is an incorporated association without capital stock, chartered under the laws of Connecticut. Its affairs are governed by a Board of Directors, elected every two years by the general membership. The officers are elected or appointed by the Directors. The League is non-commercial and no one commercially engaged in the manufacture, sale or rental of radio apparatus is eligible to membership on its board.

"Of, by and for the amateur," it numbers within its ranks practically every worth-while amateur in the world and has a history of glorious achievement as the standard-bearer in amateur affairs.

Inquiries regarding membership are solicited. A bona fide interest in amateur radio is the only essential qualification; ownership of a transmitting station and knowledge of the code are not prerequisite. Correspondence should be addressed to the Secretary.

## OFFICERS

*President*.....HIRAM PERCY MAXIM, W1AW  
Hartford, Connecticut

*Vice-President*.....CHARLES H. STEWART, W3ZS  
St. David's, Pennsylvania

*Secretary*.....KENNETH B. WARNER, W1EH  
West Hartford, Connecticut

*Treasurer*.....ARTHUR A. HEBERT, W1ES  
West Hartford, Connecticut

*Communications Mgr.*...E. EDWARD HANDY, W1BDI  
West Hartford, Connecticut

---

*General Counsel*.....PAUL M. SEGAL, W3EEA  
1010 Shoreham Building, Washington, D. C.

Address all general correspondence to the executive headquarters at West Hartford, Connecticut

# The American Radio Relay League

## DIRECTORS

*President*  
HIRAM PERCY MAXIM.....W1AW  
Box 216, Hartford, Conn.

*Vice-President*  
CHARLES H. STEWART.....W3ZS  
St. David's, Pa.

*Canadian General Manager*  
ALEX. REID.....VE2BE  
169 Logan Ave., St. Lambert, P. Q.

*Atlantic Division*  
EUGENE C. WOODRUFF.....W8CMP  
234 W. Fairmount Ave., State College, Pa.

*Central Division*  
LOREN G. WINDOM.....W8GZ-W8ZG  
1375 Franklin Ave. Columbus, Ohio

*Dakota Division*  
CARL L. JABS.....W9BVH  
1822 James St., St. Paul, Minn.

*Delta Division*  
M. M. HILL.....W5EB  
P.O. Box 274, Natchitoches, La.

*Hudson Division*  
BERNARD J. FULD.....W2BEG  
280 Broadway, New York City

*Midwest Division*  
H. W. KERR.....W9DZW-W9GP  
Little Sioux, Iowa

*New England Division*  
G. W. BAILEY.....W1KH  
74 Webster Road, Weston, Mass.

*Northwestern Division*  
RALPH J. GIBBONS.....W7KV-W7BIX  
3134 N. E. 25th Ave., Portland, Ore.

*Pacific Division*  
S. G. CULVER.....W6AN  
2962 Russell St., Berkeley, Calif.

*Roanoke Division*  
H. L. CAVENESS.....W4DW  
State College Station, Raleigh, N. C.

*Rocky Mountain Division*  
RUSSELL J. ANDREWS.....W9AAB  
1867 So. Lafayette St., Denver, Colo.

*Southeastern Division*  
J. C. HAGLER, JR.....W4SS  
2424 McDowell St., Augusta, Ga.

*West Gulf Division*  
FRANK M. CORLETT.....W5ZC  
2515 Catherine St., Dallas, Tex.

The British Radio  
**Hammarlund**  
PRECISION  
PRODUCTS

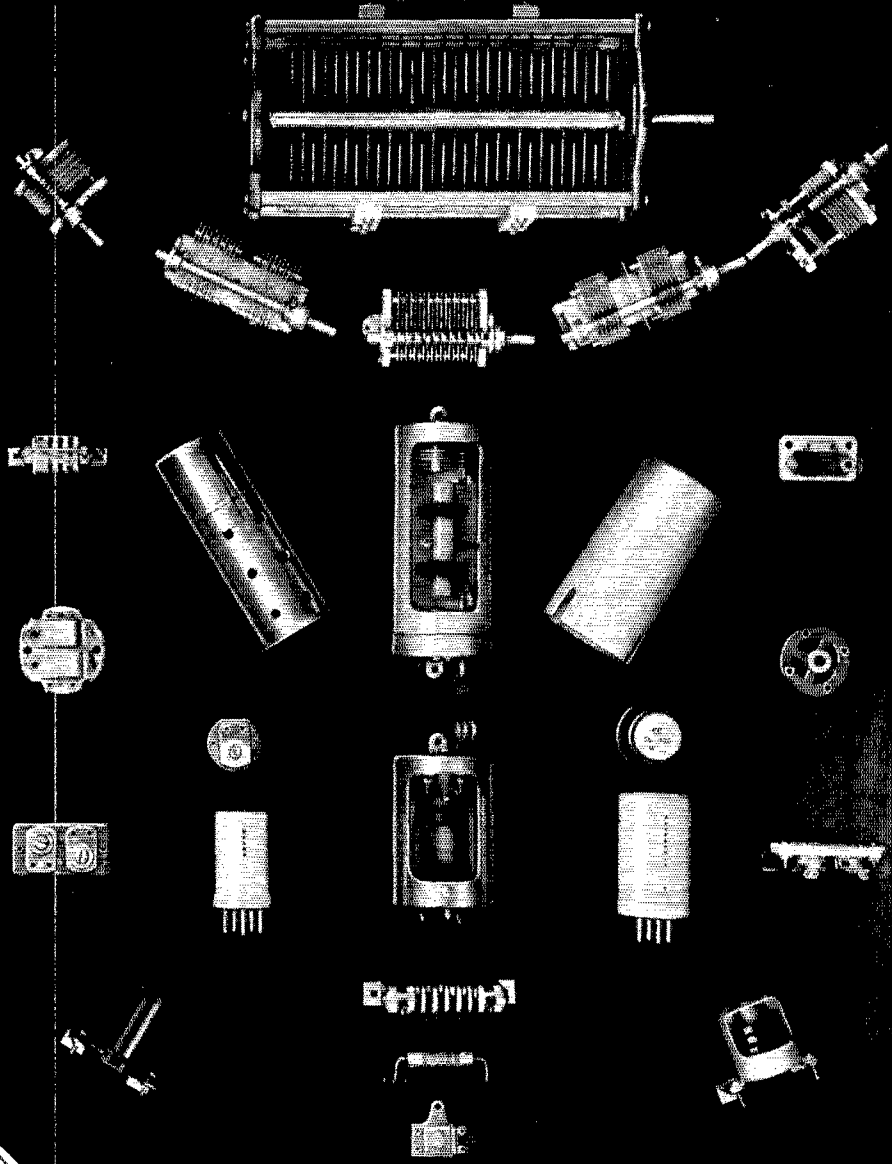

For Better Radio  
**Hammarlund**  
PRECISION  
PRODUCTS

Write Dept. Q-5 for Complete New Catalog. FREE for the Asking

# Congratulations A.R.R.L. /

**A**T 20 years, you are a handsome, sturdy youngster and deserve a fling.

Permit an old-timer of 24 to celebrate with you.

Since 1910, Hammarlund has marched right up front of the radio parade. And it has always been gratifying to have the company of that fine army of amateurs to whose inquisitiveness, determination and skill radio owes so much of its progress.

On the opposite page are pictured some of Hammarlund's newest contributions to better radio. These, and the world-famous COMET "PRO" Receiver are your working tools for 1934—tools of which you can be as proud to use as we are to have produced them.



**HAMMARLUND  
MANUFACTURING  
COMPANY**

424-438 West 33rd St.  
New York

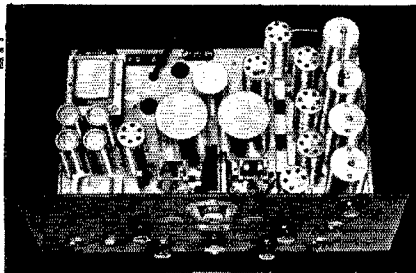

Say You Saw It in *QST* — It Identifies You and Helps *QST*



73 to my fellow amateurs  
on A.R.R.L.'s birthday.  
Hiram Percy Maxim. W1AW



# THE EDITOR'S MILL

1914-1934

WITH this issue of *QST* we commemorate the twentieth anniversary of our American Radio Relay League. A span greater than the years of many of the amateurs of to-day, it offers an impressive opportunity to reflect upon the high estate to which team-work has carried us. In 1914, with amateur radio in its swaddling clothes, with the handful of amateurs a feeble voice crying in the wilderness of despair, A.R.R.L. existed only as a grand idea in the mind of our founder-president, its only asset his will to see the idea through. To-day we can look back upon twenty years of accomplishment during which we have builded our own unique coöperative association, healthy, mutually-owned, self-supporting, enjoying recognition as our spokesman, prestige as our representative before the world.

We like to tell the tale of how A.R.R.L. came into being. With the crude apparatus of those early days, amateurs could not talk from one town to the next. But an intermediate amateur could *relay* for them, if only there were some mutual understanding that each amateur would willingly so aid his fellows. Organization to supply this mutual need would work wonders, and if this spirit of one for all and all for one could help in practical operating, how much greater its opportunities in the realms of fraternalism and protection! And the organization should be owned by the amateurs themselves, not run for profit but for their common good.

This was the Maxim vision of 1914. How the idea took form is an enthralling story of coöperative accomplishment. Early birds remember the little brown callbooks, the map of relay stations with a dot for every member, the little blue-backed *QST*'s mailed from the "office" in the attic of Tuska, our first secretary-editor, himself a college youth. Those were the beginnings. How richly the idea has succeeded is attested by the *QST*'s of the years, and by our numbers and strength to-day, and is, we hope, reflected in this present birthday number of our magazine.

We hams of America owe something to the men who have built up A.R.R.L. First and always is the Old Chief, Hiram Percy Maxim. And there is Tuska, founder of *QST*. Then there are the seventy-odd amateurs who during the years have sat as members of our Board of Directors, giving from their hearts of their time and thought that A.R.R.L. might advance. We always think with particular pride of that Board back in 1923 that deliberately voted itself out of office that A.R.R.L. might enjoy a truly representative form of government. And then there were those hundreds of amateurs who lent the League thousands of dollars as working capital for the first two years after the war, with no security except their firm faith in a non-commercial amateur-owned society. These are but typical examples of the amateur spirit that has built our League.

Let us not forget to-day that we have achieved these things by mutual forbearance, by the control of selfishness, by team-work. We have created something that is without parallel in American life, representative of all that is fine in a good clean game. We may all be proud of it. Let us not be misled by those who, actuated by greed and jealous of our success, seek to take the control of our hobby into their hands and by planned misrepresentation are endeavoring to weaken our faith in our own selves. We have come a long way in twenty years, shoulder to shoulder. Together we have worked these marvels. We know that amateur radio has a rich destiny. Arm in arm we go on towards it.

K. B. W.



# Some Anniversary Greetings

FROM every section of the far-flung empire of American radio, birthday messages have come to our headquarters as A.R.R.L. announces its twentieth anniversary. Although it was natural to hope that some of those prominent in the communications art would wish us "many happy returns of the day," we were quite unprepared for the flood of felicitations that has reached us. We proudly publish these letters, knowing that the members of A.R.R.L. will be interested in reading the messages which so many famous and prominent people of the communications world have been kind enough to send us, and in the belief that every amateur will be glad to see this evidence of the esteem in which his organization is held.

## From the PRESIDENT OF THE UNITED STATES:

"I am glad to add my felicitations and congratulations to the American Radio Relay League on the occasion of its twentieth anniversary celebration.

"It is generally conceded that amateur radio is a great training school for the radio art and industry. It is most gratifying to note that more than forty-five thousand Americans devote much time daily to the study and practical application of radio communications. The liaison of the radio amateurs with the Army Signal Corps and with the Naval Communications Reserve, indicates that the Government fully appreciates the amateur radio operators and stands ready to encourage them in every possible manner.

"The fact is that the future of radio depends to a large extent on the amateurs, for it is their initiative, enthusiasm and ingenuity that overcomes radio barriers and leads to new frontiers, putting new problems up to science.

"The American Radio Relay League has assumed grave responsibilities in undertaking to guide the radio amateurs along the proper paths, directing their activities and inspiring their efforts. However, your monthly journal *QST* gives conclusive evidence that you are discharging that responsibility in a most commendable manner."



## From SENATORE GUGLIELMO MARCONI:

"I have much pleasure in conveying through the special birthday number of *QST* my warmest greetings to all radio amateurs and in complimenting them on their achievements so effectively fostered by the American Radio Relay League."



## From the HONORABLE HERBERT HOOVER, former President of the United States:

"I would be glad indeed if you will convey through *QST* my greetings to the many thousand members of the American Radio Relay League. As you know, I have felt over these many years since the association started that the amateurs were making a positive contribution to the development of radio. I recall with great pleasure the years of coöperation in which I was able to join with them. I trust that the organization will continue to grow and to meet with continued success."

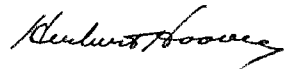

*From ADMIRAL W. H. STANDLEY, U.S.N., Acting Secretary of the Navy:*

"On the occasion of the twentieth anniversary of the American Radio Relay League, the Navy Department extends hearty congratulations and every good wish for continued success."



*From the HONORABLE CLARENCE C. DILL, United States Senator from Washington, Chairman of the Senate Committee on Interstate Commerce, co-author of the Radio Act of 1927:*

"I congratulate the American Radio Relay League on its twentieth anniversary.

"The millions who enjoy radio and are benefited by its many services to the American family have no conception of the work that amateurs have done during the past twenty years for the development of radio into its present form.

"I assure you of my continued interest in the amateurs and my desire to be of whatever assistance I can in a legislative way."



*From the HONORABLE EUGENE O. SYKES, Chairman of the Federal Radio Commission:*

"It affords me great pleasure on the occasion of the twentieth anniversary of the American Radio Relay League to extend a message of greeting and congratulations to your organization and to amateur radio generally.

"Ever since the creation of the Federal Radio Commission in 1927, it has been my privilege and pleasure as a member of that body to encourage the splendid growth of amateur radio and to appreciate the outstanding contributions to the radio art which originated with amateurs.

"This Government has taken the lead among the nations of the world in fostering and developing amateur radio, and your coöperative response has more than justified this policy."

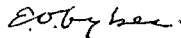

*From MAJOR GENERAL IRVING J. CARR, U.S.A., Chief Signal Officer of the Army:*

"On the occasion of the twentieth anniversary of the founding of the American Radio Relay League, permit me to extend to its officers, representatives, and entire personnel my hearty congratulations and best wishes for a continuation of the growth and future usefulness of your splendid organization.

"The Signal Corps is now, no less than in the past, vitally interested in the radio amateurs and has a keen appreciation of their affiliations and various activities.

"I am gratified accordingly to observe that its membership is so firmly established as a permanent and world-wide institution."

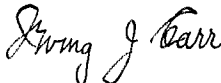

*From MAJOR GENERAL BENJAMIN D. FOULLOIS, U.S.A., Chief of the Air Corps:*

"I am indeed proud of this opportunity to extend greetings on behalf of the Army Air Corps to The American Radio Relay League on this, its twentieth anniversary.

"Having been personally interested in the development of radio from the standpoint of the amateur as well as in its adaptation to military aviation since the early days, I can assure you that I fully appreciate the work engaged in and the progress made by the League during the past twenty years.

"The League and the Army Air Corps have grown simultaneously and the relations between the members of the two organizations have been, and I hope will continue to be, most cordial and helpful."

*From REAR ADMIRAL H. G. HAMLET, Commandant of the United States Coast Guard:*

"I find great pleasure in extending to the American Radio Relay League my best felicitations on the occasion of its twentieth anniversary. The remarkable accomplishments of the American radio amateurs in furthering radio communication have been a valuable contribution to the public welfare. The United States Coast Guard in times of flood, earthquake, and other unfortunate visitations, has found the American amateurs a willing and useful ally giving that sort of cooperation which speaks for service. On such occasions, when communication with the rest of the country is interrupted and broken, the amateur, true to tradition and aspiring always to be of service, has come through with the news thereby assisting relief agencies intelligently to carry on operations. I wish the League the fullest measure of success and continued usefulness in its important field of endeavor."



*From CAPTAIN S. C. HOOPER, U.S.N., Director of Naval Communications, Navy Department:*

"I desire to convey to you the congratulations of the Naval Communication Service on the occasion of the celebration of the twentieth anniversary of the American Radio Relay League.

"The twentieth anniversary of the American Radio Relay League is an important milestone in the history of the development of radio. It speaks well for the careful foundation upon which the League was organized twenty years ago. It emphasizes the able administration under which the League has conducted the affairs of the radio amateur.

"Having been closely associated with radio during these years, I am well acquainted with the many problems which have confronted amateur radio.

"The Navy is gratified, also, that several officers and many members of the American Radio Relay League are members of the Naval Communication Reserve. This close association has strengthened the pleasant bond between the two organizations and has brought about a clear understanding of our common purpose.

"Please accept my sincere good wishes for continued happiness and success."



*From DR. J. H. DELLINGER, Chief of the Radio Section, Bureau of Standards:*

Dear Mr. Maxim:

"I extend my hearty congratulations to you and to the American Radio Relay League upon the completion of twenty years of fruitful activity in amateur radio. Your field is a conspicuous example of a hobby which has by-products of utilitarian value. I am happy to acknowledge the aid given by the amateurs on the advancement of radio science. The Bureau of Standards has called on the amateurs, through the League, for collaboration in a number of projects, and has always met a cordial and effective response.

"I congratulate you not only on the splendid record which the League has made but also on the bright future of amateur radio. The amateurs have won a definite place for themselves in the scheme of things radio. This has been in large part accomplished through the organization of their activities in the American Radio Relay League, and this effective organization in turn has in large measure sprung from your leadership."



*From PROFESSOR A. E. KENNELLY, president of the Union Radio Scientifique Internationale, discoverer of the Kennelly-Heaviside Layer:*

Dear Mr. Maxim:

"I wish to convey to the American Radio Relay League, as well as to yourself, the president since its inception, my hearty greetings upon the League's attainment of its twentieth anniversary.

"It is unnecessary for me to mention the great debt of thanks that the world owes to the past work of radio amateurs, in discovering and developing the possibilities of short-wave radio communication, now so much used in industrial radiotelegraphy. The history of amateur radio during the past twenty years is also closely interwoven with much valuable volunteer work in emergencies of all kinds all over the world. The radio amateur has often given valuable aid under circumstances where other means of communication were unattainable.

"Commencing in the spring of 1914, with a small group of enthusiastic young amateurs, using short-range spark coils, the A.R.R.L. has steadily advanced in numbers, equipment and experience, until to-day the total exceeds, I believe, 60,000.

"In our childhood, we read of fairies, witches, and other supernatural folk careering abroomstick over the skies. The A.R.R.L. has out-realized those nursery tales with nothing but an antenna as a vestige of the broom fancy, for the radio amateur actually launches his personality into the upper air beneath the layered ionosphere almost at light speed, and calls upon his friends, perhaps half-way around the world—friends whose language he may not know, and whom he may never be able to meet face to face—to close the circuit of his thought.

"The messages our radio amateurs exchange are bright with greeting, sympathy, and good cheer. The radio amateur language is highly distinctive, being mostly basic English interlarded with many international code-letter groups and abbreviations, more euphonious when transmitted than when vocalized. It sounds cheerily in buzzing dots and dashes through the head-phones of the listening amateur. *QST* is its journal and its theme is 73. What an army of goodwill and international amity are the world's radio amateurs! Their whisperings over all the oceans make for peace. So long as the amateurs are allowed to talk to each other freely, the world's peace is assured. Only with war and violence is the amateur's voice hushed.

"We all hope that in the next twenty years, these knights of the joyous venture may continue their happy and helpful service to mankind, utilizing the ionosphere which radio science ever seeks to explore and understand. As in the past, we must all endeavor to make their useful influence realized internationally; so that modestly-adequate channels may be reserved for their activities in the great spectrum of radio-frequency allotments. Congratulations and success!"

Arthur E. Kennelly

From MR. ROBERT E. BONDY, Director of Disaster Relief, The American Red Cross:

"I am pleased to send the greeting of the American Red Cross to the thousands of radio amateurs on the occasion of the Twentieth Anniversary Celebration of the American Radio Relay League.

"The League and the Red Cross share some unique characteristics. We are both organized for unselfish public service. The length and breadth of the land is the sphere of our activity. Our regular activities go on day by day as a great foundation for the emergency activities that form a significant part of our programs.

"The American Red Cross is given particular responsibility under its Congressional Charter for service in time of great disaster. With an average of over 80 disasters a year calling for Red Cross relief in this country, one of our most constant needs is that of prompt and adequate communication service.

"For speed is the essence of effective disaster relief. With hurricanes and floods, warnings in advance of the disaster may be given. Programs of preparedness for the protection of lives and property are carried through by local Red Cross chapters when warning comes in time. Our experiences in the recent hurricanes of last year when compared with the hurricanes of several years ago, show very striking records of reduced loss of life and injuries because of early warning and preparedness measures taken in cooperation with the United States Weather Bureau and facilitated by amateur radio operators and other facilities available for communication purposes.

"Once the disaster strikes, the Red Cross director on the field of the operations must maintain constant communication with his headquarters in Washington, St. Louis or San Francisco. His needs for personnel, his needs for supplies, and the amount of money needed for relief purposes must be promptly transmitted. Instructions go back to the director of the field operation from his headquarters' office. Failure to maintain communication may mean the serious hampering of relief and unnecessary suffering.

"For these reasons, we urge our Red Cross Chapters—and there is one in practically every county in the country—to become acquainted with the amateur radio operators, interest them in becoming a part of the chapter disaster preparedness program and be prepared to work in close contact with the amateurs when disaster comes. There have been many situations in which the service of amateurs has been invaluable and vital to successful relief. Our joint experience is enabling us to perfect this system of emergency communication and on the occasion of this Twentieth Anniversary of the American Radio Relay League we are happy to extend our thanks for these many services and to wish for the League and its great membership, an ever widening sphere of usefulness and service."

Robert E. Bondy

*From MAJOR GENERAL C. McK. SALTZMAN, U.S.A., Retired, former Chief Signal Officer of the Army during whose administration the Army-Amateur affiliation was inaugurated; former Chairman of the Federal Radio Commission:*

"On this twentieth anniversary of the American Radio Relay League, permit me to extend my greetings and congratulations to the League.

"I grew up in the communication game with the Signal Corps of the Army under the leadership of a very distinguished man, General A. W. Greely, who imbued that Corps, as he built it, with a progressive and constructive spirit and a desire to be ever on the alert for participation in all technical advancement and development. Later, when I was Chief Signal Officer of the Army, I noticed this same spirit in the A.R.R.L. and was delighted when it affiliated with the Corps.

"As it looks back to-day over twenty years of remarkable growth and accomplishment, the League should take great pleasure not only in the realization of its success but in the fact that its success has been due to its progressive and constructive spirit and its fundamental desire to be ever on the alert to participate in all technical advancement."



*From SEÑOR DON JULIO PRIETO, President of the Liga Mexicana de Radio Experimentadores:*

"It is a great pleasure to the Liga Mexicana de Radio Experimentadores to send the American Radio Relay League, upon its twentieth anniversary, our hearty congratulations and sincere wishes for the continued success of your brilliant work which has been a strong stimulus for our own national radio society.

"We feel that the A.R.R.L., founded by Hiram Percy Maxim, one of the foremost radio pioneers, has set an imperishable mark in the history of radio communication by leading the amateur to the most striking victory of a scientific nature that has ever been accomplished by such a vast group of human beings. Its official organ, *QST*, a true bible, has sent wisdom and optimism, reaching the amateurs even in the remotest corners of the world. The A.R.R.L. is and always will be a most valuable help to the I.A.R.U. in safeguarding the interests of the amateur against the attacks of the European bureaucracies at the international radio conferences."

*From DR. C. B. JOLLIFFE, Chief Engineer of the Federal Radio Commission:*

"The Engineering Division of the Federal Radio Commission extends its hearty congratulations to the American Radio Relay League on the occasion of its twentieth birthday.

"The radio profession is proud to number present and former amateurs among its outstanding representatives. Their contributions to radio as a whole, and particularly to the short-wave field, have been distinguished by the pioneering work in research and operation which has marked them as leaders. It is our belief that the scientific spirit of adventure which is such an essential part of this leadership will carry amateur radio on to new and greater fields."



*From DR. LEE DE FOREST, inventor of the three-element vacuum tube:*

"The celebration of the Twentieth Anniversary of the A.R.R.L. brings back to my memory, as it must to those of your founders and first members, incidents of the infant days of radio which we know to-day.

"For it was in 1914 that the first oscillating three-electrode tube was presented to the world. The first heterodyne and autodyne detectors were then initially demonstrated to our Navy and put into actual military and commercial service.

"It was in this period that 'amateurs' began to haunt my doors seeking the privilege of owning an audion tube, of the globular, 'double-wing' double-grid Hudson-filament type, the only ones then known, with which each ambitious ham sought to out-distance his rival. And many were the incredible tales I listened to of unheard-of records, generously accredited to that little grid.

"And it was in no small measure the loyal and eager patronage, the hard-found dollars from the ever-spreading hordes of hams, which during those struggling pre-war and patent-litiga-

tion days enabled my early work of development of the audion, ultraudion, and oscillion to continue.

"I have been ever mindful of this, and ever grateful to A.R.R.L. for what its members have done towards thus aiding the development of the New Radio, at a time when such support was most needed.

"And what this nation and all nations owe to the Radio Amateur — for his eager enlistments during the War, for his sleepless vigilance in time of storm or disaster, his ever-ready aid to explorers, the MacMillans, the Byrds, for his clever ingenuity in developing new hook-ups, his cheerful willingness, when forced into 'useless' short-wave bands, to carry on and thereby demonstrate to older engineers in an art already become conservative and skeptical — until to-day the entire world spins enmeshed in a friendly web of antipodal CQ megacycles — these not all the volumes of a thousand *QST*'s can ever adequately record!

"Foremost in this world awakening to the marvels and the friendliness of short-wave wireless will always stand the American Radio Relay League. May your ensuing twenty years be filled with joy of accomplishment and service to mankind equal to those of your first!"

*Lee de Forest*

*From MR. BOND GEDDES, Executive Vice-President of the Radio Manufacturers Association:*

"The American Radio Relay League is to be congratulated on its splendid service covering two decades. When we review the brief but momentous career of radio and realize that our industry sprung from the activities of amateur experimenters, the pioneers of our broad technical development, then only can we appreciate the great service of those amateurs. Their contributions are not ended. To-day they continue to be a great force in the march of radio and allied scientific progress."

*Bond Geddes*

*From MR. W. D. TERRELL, Chief of the Division of Field Operations of the Federal Radio Commission, first American radio inspector, for many years the administrator of amateur radio as Director of Radio of the Department of Commerce:*

"First I desire to congratulate the American Radio Relay League upon its Twentieth Anniversary. I believe the A.R.R.L. and *QST* and the men behind them have contributed much to orderly operation and to amateur success in this country.

"Twenty years ago was the beginning of somewhat orderly amateur operating. Prior to that time there was little or no restraint upon the amateur. The amateurs used call letters of their own selection, frequently two letters and often their initials. They used such wavelengths as their antenna would permit. The power of their transmitters was limited only by their available cash. The amateur was practically unknown outside of his immediate circle. The interference he produced was largely aural, caused by straight and rotary spark gaps. These devices were greater disturbers of sleep than the loud-speaker of to-day.

"With the advent of broadcasting it became necessary to impose some restrictions upon the amateurs such as quiet hours, discontinuance of spark transmitters, and specified bands of frequencies. However, the amateurs had already discovered the advantage of tube transmission on high frequencies and the majority of them had abandoned the spark sets. Few, if any, amateurs to-day have a station that is not far more effective than the best commercial stations of twenty years ago. In the old days the commercial companies paid a bonus to operators who could transmit their messages direct from Puerto Rico and similar points to New York and this feat, when accomplished, was usually after midnight. To-day the amateur transmitting range seems to have no limitation. It is routine work with amateurs to communicate with any of the five continents and also with Little America.

"In 1914 there were approximately 5,000 amateur operators. At the end of the last fiscal year there were 41,555 licensed amateur stations. It should be said to the credit of the amateur that the problem of regulation of the more than 30,000 amateur operators is no more difficult to-day than it was twenty years ago. *QST* has undoubtedly done its part in making the regulations clear to the amateurs and in helping them with their problems of meeting these regulations.

"I wish *QST* continued success and congratulate the amateurs upon having such a dependable and enlightening magazine. The success of the League no less than the success of the American amateurs themselves is due largely to the untiring efforts of its president, Hiram Percy Maxim."

*Hiram Percy Maxim*

*From DR. A. HOYT TAYLOR, Superintendent of the Radio Division of the U. S. Naval Research Laboratory:*

"When the Naval Research Laboratory started its pioneer work in the high-frequency band in 1923, there were no naval ships or stations operating in this band except those using the old inter-Fleet sets on 125 and 150 meters. The receivers for this work were of very narrow range and not at all sensitive.

"We therefore turned to our amateur friends for help in studying the properties of these new frequencies and in developing a suitable wave-propagation theory. Of course, during the war I came in contact with hundreds of able amateurs, many of whom served under my command, and it was a very natural thing for me to turn to the amateur fraternity for help in the emergency of 1923.

"From then on until 1927 and to a more limited extent since that time we have continued to use amateurs for assistance in this important work. The responses to our original request were extremely gratifying and I am frank to say that without the assistance of the amateurs, the high-frequency program in the Navy would be very much behind what it is to-day. I shall never cease to be grateful for this willing assistance and shall never forget the many friends I made as a result of these contacts.

"Of course, as time went on more and more high-frequency contacts were possible within our own Service so that the necessity for relying so heavily on the amateurs gradually went out of the picture. However, if similar conditions were to arise to-day I should not hesitate to again call on the amateurs for active coöperation with the absolute certainty that I would get the same hearty and cordial response. You may be sure that the American Radio Relay League and the amateurs of the United States have a very special place in the regard of all the members of the Naval Research Laboratory staff who have had to do with such contacts."

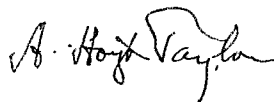

*From MR. PHILIP G. LOUCKS, Managing Director of the National Association of Broadcasters:*

"I am afforded considerable pleasure in congratulating the American Radio Relay League on the occasion of completing twenty years of phenomenal progress.

"Many broadcasters and broadcast technicians got their start in amateur radio and all of us acknowledge a marked interest in amateur activities. The amateur has in many instances led the way into unexplored fields and we, who utilize radio facilities in serving public interest, constantly look to the amateur to discern trends of any developments in an absorbing art.

"The legislative protection and technical guidance afforded the amateur by the American Radio Relay League constitute a record of which the League may well be proud.

"I hope the next twenty years will be as eventful and successful for the American Radio Relay League as the past twenty years have been."

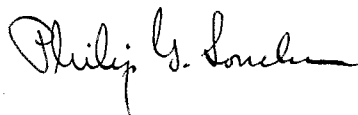

*From MR. BERNARD H. LINDEN, Federal Radio Commission Inspector in Charge at San Francisco:*

"Surely felicitations are in order on the twentieth anniversary of an organization such as the American Radio Relay League, which has accomplished so much for the radio amateur and rendered such valuable assistance to the Government in the enforcement of radio laws and regulations and in emergencies, etc. Unquestionably, the effects of the organization extend to the proverbial four corners of the earth. The League is a clearing house, one might say, for national and international amateur problems—the amateur's spokesman. Without such an institution there could be no coördinated action for the mutual benefit of those concerned.

"It has been my pleasure to witness the growth of the American Radio Relay League and its magazine *QST* since its inception and I can, therefore, with authority add my commendation to the many others which will be received for the manner in which they have been managed and for the support given by their constituents.

"I wish to express my appreciation for the wholehearted coöperation extended by the American Radio Relay League and the amateurs of this District during my now nearly one score years of association with this office, and to congratulate Mr. Hiram P. Maxim for his untiring efforts in behalf of the radio amateurs for twenty years as president of the American Radio Relay League."

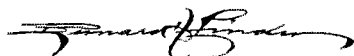



*From MAJOR GENERAL GEORGE S. GIBBS, U.S.A., Retired, former Chief Signal Officer of the Army, President of Postal Telegraph-Cable Company:*

Dear Mr. Warner:

"It affords me genuine pleasure to avail myself of this opportunity to send you my greetings on the twentieth anniversary of the American Radio Relay League.

"In any line of endeavor — whether it be the arts or sport — nothing is finer or contributes, unselfishly, more to its development than the spirit of amateurism. That is what the A.R.R.L. has done for radio.

"It is another phase of your activities, however, to which I do desire sincerely to pay tribute. That is the splendid work of training personnel, chiefly young men and boys in their teens, for military and commercial radio service.

"In the World War, I suppose the large majority of our Army and Navy operators came from the ranks of the amateurs. Many of the officers and department heads of the large radio companies to-day originally began their radio careers as "hams," and our operators, too, in many cases came from the same ranks. Since the War, the reserve communication activities of both the Army and Navy have centered largely around the radio amateur.

"You and your organization have done and are doing a splendid job and I send you my warmest wishes for continued progress and success in amateur radio."



*From DR. WALTER G. CADY, Professor of Physics at Wesleyan University, who gave the world "Crystal-Control":*

"The American Radio Relay League deserves the admiration of all who are interested in radio, and this means the whole civilized world. Most of all, their achievements should be recognized by those who are in a position to understand the many constructive contributions that the League has made to the art of radio. We cannot forget the valuable inventions that have been made by League members, nor the men now occupying responsible positions who received their early training in the League. Outstanding, of course, is the pioneer work in the development of short-wave communication, which has become of great benefit to mankind as well as of enormous commercial importance.

"In no other country have the amateurs played so vital a part in the development of radio. Working, as has frequently been the case, with slender means and meager equipment, they offer striking proof of the old adage that "Necessity is the mother of Invention."

"My heartiest congratulations go out to the American Radio Relay League, with the hope that its next score of years may be even more prosperous than the first."

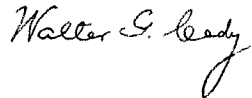

*From MR. DAVID SARNOFF, President of the Radio Corporation of America:*

Dear Mr. Maxim:

"My congratulations to the American Radio Relay League on the occasion of its Twentieth Anniversary.

"The radio amateurs who comprise the organization of which you are president have come a long way forward since those early days when spark coils and crystals first made possible two-way communication between neighborhood experimenters. To-day, signals from amateur transmitters bore through thousands of miles of space and link your members with kindred spirits in many countries of the world.

"As one who has given generously of inspiration and service in this development it must be gratifying to you to contemplate the possibilities for pleasurable and educational adventure, beyond national borders and even oceans, which thus have been made available to thousands of American amateurs."



From **CAPTAIN GARLAND C. BLACK**, *Signal Corps, U.S.A., Liaison Officer of the Army-Amateur Radio System:*

"I congratulate the American Radio Relay League upon the splendid record of accomplishments achieved during the past twenty years of its existence.

"The adoption of and adherence to an amateur code that is most comprehensive has in no small measure served to place the American amateur in the position of high esteem of his country that he now enjoys.

"The period of time from 1914 to 1934 has brought about a realization of our founders' conception of the development of relay routes over all of the country among all the amateurs that recognizes no parallel or equal to-day.

"The League has been fortunate in having its organization administered by individuals who have willingly devoted long years of faithful service to the work. . . .

"Please accept my sincere good wishes for a continuation of your success."



From **MR. M. H. AYLESWORTH**, *President of the National Broadcasting Company:*

Dear Mr. Maxim:

"The American Radio Relay League is completing twenty years of real service to the American amateur, under your presidency. Through the efforts of your organization, the American amateur has been guided through many difficult periods, has gained respect and prestige and has had his interests protected. The League has coordinated amateur efforts until they have become a recognized force ever ready to serve the public interest in the event of emergency.

"I wish to congratulate you, your associates and the entire membership of your organization on this anniversary and hope that the League will continue to grow and prosper as it justly deserves to do. The League's fine cooperation with the broadcasting industry merits high praise.

"You may well take pride in the fine work which the American Radio Relay League already has done in furthering the technical development of the art. As you know, many of the leading technical men of the National Broadcasting Company have been amateurs, and in fact many of them still are at heart. They join me in wishing you and your organization every future success."

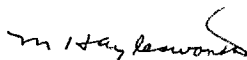

From **PAUL F. GODLEY**, *developer of pioneer amateur short-wave regenerative receivers, who first received American amateur signals in Europe in the A.R.R.L. transatlantic tests of 1921:*

"Insofar as my experience and observation goes no effort has met with quite such complete success as that one so enthusiastically begun in Hartford twenty years ago under the name of the American Radio Relay League.

"That was a happy day for budding manhood, for an infant industry, for a young nation, and for a new order of world-wide mental processes!

"It is impossible to view the work of the League — past and present — without the greatest of admiration for the unselfish service rendered by its president and founders, its officers and workers and its members and well-wishers. All have, for the finest of reasons, a tremendous pride in their contributions.

"I congratulate you all, and rejoice with you all on this happy occasion. Amateur radio is worthy of your efforts and your devotion. For, in my opinion, it has yet to reach its greatest strides."

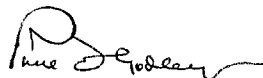

From **DR. ORESTES H. CALDWELL**, *President of the New York Electrical Society, former Federal Radio Commissioner, editor of "Electronics":*

"Hearty congratulations to the American Radio Relay League on the great things accomplished during your twenty years of eventful history.

"Your amateurs have achieved surprising results in space radio. Indeed, you have about taxed the resources of this old globe to provide a playground for your radio experimentation.

"But the thoughtful amateur has still greater thrills ahead, I believe, as he applies his radio knowledge to non-space applications — the new and expanding arts of electronic tubes and circuits, applied to industry, science, the arts, and everyday life in the world about us.

"These new expansions of radio principles, amplification, electron optics, graphical reproduction, control, etc., offer even more fascinating fields for your members and for the thousands of amateurs whom your League so ably represents. And I have no doubt that your members will pioneer still new paths into the boundless domain of electronics, just as they have done in opening up new services and uses of the radio spectrum."



*From MR. WILLIAM S. PALEY, President of the Columbia Broadcasting System:*

"It is with a feeling of genuine appreciation that I congratulate the American Radio Relay League on the celebration of its twentieth anniversary. In the development of major industries as in the growth of sports, the amateur precedes the professional; and we in commercial broadcasting owe a debt of gratitude to you who first broke ground in the limitless field that is radio.

"Our spheres of endeavor are separate but complementary, and the great progress that you have made in the past twenty years has been an inspiration to us. It is my hope that the next two decades in the relatively brief history of radio will witness developments of even larger import in our respective phases of radio."

*From MR. PAUL GOLDSBOROUGH, President of Aeronautical Radio, Inc., representative of radio in aviation:*

"In connection with the twentieth anniversary of the American Radio Relay League it seems opportune to extend greetings and congratulations to your group through the special birthday issue of *QST*.

"Our own organization is largely made up of amateurs, so this greeting is really just a friendly word from within the ranks. We wish the A.R.R.L. continued success in its fine work."



*From MR. H. H. BEVERAGE, Chief Research Engineer of R.C.A. Communications, Inc.:*

"It makes me feel old to look back 25 years to 1909 when I received the first wireless signals I had ever heard, using a homemade "double slide" tuning coil and a galena crystal. I can also recall the thrill of contacting another amateur, 20 miles away, with an Electro Importing Company one-inch spark coil operated from old dry cells discarded from a motor boat.

"Astounding developments in radio communication have taken place during those 25 intervening years, and many of these developments have been due to men who were "dyed-in-the-wool Hams" at some time in their career. Amateur experience develops a knowledge of the vagaries of the transmission path and a technic in handling radio equipment that is difficult to acquire in any other way.

"When Paul Godley reported that he had heard my old ham set, 2BML, in Scotland, I figured that there was not much more that could be done, so I presented my equipment to Mr. Bourne. "RB" had operated it during the Scotland tests, since I was in London at the time.

"While I have not owned an amateur station since 1921, I have continued to follow the activities of the amateur with unabated interest through the pages of *QST*. The A.R.R.L. has certainly accomplished much for the American amateur, especially in helping to raise the standards of amateur equipment, and in maintaining and safeguarding the amateur frequency assignments against insistent world demands."



**ANNOUNCEMENT**

QST is published by and at the expense of Hiram Percy Maxim and Clarence D. Tuska.

Its object is to help maintain the organization of the American Radio Relay League and to keep the Amateur Wireless Operators of the country in constant touch with each other.

Every Amateur will help himself and help his fellows by sending in \$1 for a 12 months subscription.

THE PUBLISHERS OF QST

**Q S T**

A Magazine Devoted Exclusively to the Radio Amateur

**WAR!**

MEMBER OF THE NATIONAL ASSOCIATION OF PUBLISHERS

QST is published by and at the expense of Hiram Percy Maxim and Clarence D. Tuska. Its object is to help maintain the organization of the American Radio Relay League and to keep the Amateur Wireless Operators of the country in constant touch with each other. Every Amateur will help himself and help his fellows by sending in \$1 for a 12 months subscription.

**Q S T**

A Magazine Devoted Exclusively to the Radio Amateur

**Building Your Own C. W. Apparatus**

Do you want to build your own C. W. apparatus? This is the time to do it. The war has created a demand for such apparatus that has never before existed. The Government is buying in large quantities and the amateur is being encouraged to do so. This is a good time to build your own apparatus. It will save you money and give you a sense of accomplishment. The war has also created a demand for such apparatus that has never before existed. The Government is buying in large quantities and the amateur is being encouraged to do so. This is a good time to build your own apparatus. It will save you money and give you a sense of accomplishment.



**Q S T**

A Magazine Devoted Exclusively to the Radio Amateur  
**The Transatlantic Triumph**  
By the Editor

The transatlantic triumph of the radio is a story of the greatest achievement in the history of the world. It is a story of the triumph of the human mind over the elements of nature. It is a story of the triumph of the human spirit over the forces of darkness. It is a story of the triumph of the human race over the forces of evil. It is a story of the triumph of the human race over the forces of death.

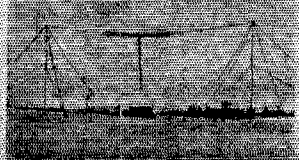

**TWENTY YEARS OF**  
*The History and Achievements of*

1914: Amateur radio . . . a group of experimenters, two thousand, more or less . . . scattered throughout the country without cohesion or mutual recognition . . . bearing each other, talking with each other occasionally over distances of 10 to 100 miles for stations up to a kilowatt, of up to 300 for those with boundless luck and pocketbook . . . vaguely regulated by the government to the extent of license issuance . . . other than that, every man for himself! . . . The audion bulb was being mentioned in awed tones . . . a few of the big fellows had them, and debated righteously about the amount of glow that gave the best sensitivity . . .

And there it was. For three years the art had remained stagnant. It had gained recruits, idly and haphazardly, but it had not gained strength and prestige. After all, what group of scattered enthusiasts ever did possess those attributes? History may have been in the making, but the mills had stopped grinding.

In 1914 history began again.

It is January. Hiram Percy Maxim is calling to order the first meeting of the Radio Club of Hartford. Twenty-three charter members are present.

March 9th sees a banner attendance of 35. Amateur radio is booming!

**T**RADITIONAL — a Man with an Idea. Mr. Maxim had the idea. With the limited ranges of the transmitters of that time, he foresaw the necessity for relaying, if messages were to be sent over great distances. But a relay network demanded organization — and there was no organization. Yet he had seen the Radio Club of Hartford burgeon into real significance in three short months. If a local organization of radio amateurs could prosper, so could a national organization. It would have to have some community interest to make it cohesive. Regular meetings were out of the question — but the relay idea would supply the common interest, with each member doing a service for each other member!

He told the club about his idea. He suggested a name for the organization — the American Radio Relay League. A Relay Committee was appointed. Application blanks for relay stations were printed. This was in May. By June they were under way. On June 15th the sum of \$50 was voted appropriated by the club for national development. By letter and by radio the word was spread.

The amateurs of the nation hailed the idea with "eagerness and enthusiasm. . . ." — Minutes of the Radio Club of Hartford.

In October the League's first call book was published, a list of 400 stations in 33 states and Canada.

Amateur radio was booming!

In January, 1915, the American Radio Relay League outgrew the local control by the Radio Club of Hartford. Administrative control was taken over by Mr. Maxim and Clarence D. Tuska, its first secretary, and the League was incorporated under the laws of the State of Connecticut as a non-commercial organization with no capital stock.

In March, 1915 a second call book was issued, listing nearly



But on January 27th it was done. The Seefred Brothers, 6EA, started the message, which hopped by quick jumps through three intermediate stations to 1ZM, Mr. Maxim's station in Hartford. On February 27th the route was covered two-way in a single night, 2PM's message travelling to 6EA and a reply returned in one hour and twenty minutes.

A legislative menace loomed in Washington. With the backing of League members now numbering thousands, President Maxim went to Washington and successfully combated the Padgett bill, H.R.2573. Times were trying, heads were hot, natures were crotchety — but amateur radio was preserved.

The first months of 1917 saw amateur radio poised for tremendous strides in development. But in April —

*War!*

"By virtue of the authority given the President of the United States" all amateur stations were closed, antenna wires lowered, all apparatus rendered inoperative.

Volunteers!

At first, five hundred. The Navy Department requested the aid of the A.R.R.L. in enlisting that number of skilled instructors and operators — in ten days. A last broadcast went over the silenced A.R.R.L. message routes. The Navy got its men.

The July, 1917 issue of *QST* begged for 2000 more men. A lingering hope that dummy antennas might be permitted was crushed by officialdom. *QST* stopped publication with the September issue. The editor had gone to war.

Before it was over, nearly 4000 amateurs had joined the Army and Navy, the most efficient wireless signal corps possessed by any of the combatant nations. Self-trained and self-organized, they played a heroically important part in the winning of the war.

November 11, 1918. Armistice. Peace. But not for amateur radio.

It had to start its fight for existence the instant the guns in France stopped booming. A radio bill was proposed in Congress that threatened amateur radio. Eleven days after the Armistice the old Board of Direction met in New York, authorized President Maxim to attend hearings on the bill, and agreed to meet again for the purpose of getting the League reorganized.

It is December. Mr. Maxim appears before the House Committee on Merchant Marine and Fisheries. With him is the realization that the amateurs of the country and their families have already written their representatives, protesting the bill, through the League's efforts. He pleads for an hour, outlining the story of the amateur, describing his invaluable work during the war.

The bill is not even reported out of Committee.

IN FEBRUARY, 1919, the A.R.R.L. Board met again. In March they voted to reorganize the League. At a meeting on March 29th they ordered the publication of a miniature issue of *QST* to announce the reorganization — but there was only \$33 in the treasury. The dozen men present dug into their own pockets for enough to finance this first issue. Lieut. Kenneth B. Warner, formerly 9JT of Cairo, Ill., was elected paid secretary. At a meeting on May 3d the Finance Committee proposed borrowing \$7500 from League members, in return issuing certificates of indebtedness payable in two years with interest at 5% per annum. They voted to buy *QST*. Secretary Warner was ordered to lay plans for producing the first issue. Since that issue — June, 1919 — *QST* has been published uninterruptedly for fifteen years.

The A.R.R.L.'s first job on reorganization



was to get the wartime transmitting ban lifted. Secretary of the Navy Daniels blocked every move until October. Then:

*Interference.  
Lord, what interference!  
Bedlam!  
Well, it could not be Utopia.*

Supplement to QST for October 1919 (Vol. 11, No. 2)

# BAN OFF!

**THE JOB IS DONE, AND THE A.R.R.L. DID IT**

See next QST for details

---

21700-49  
NAVY DEPARTMENT  
NAVAL COMMUNICATION SERVICE  
Office of the Director  
Washington, Sept. 26, 1919

Sir:

The Secretary of the Navy authorizes the announcement that, effective October 1, 1919, all restrictions on amateur and amateur radio stations are removed. This applies to amateur stations, licensed and experimental stations of schools and colleges, and to all other stations except those used for the purpose of transmitting or receiving commercial traffic of any character, including the business of the

service of the stations. The restrictions on stations handling commercial traffic will remain in effect until the President proclaims that a state of peace exists.

Attention is invited to the fact that all licenses for transmitting stations have expired and that it will be necessary for the stations to apply to the Commissioner of Navigation, Department of Commerce, for new licenses. In so far as amateur use concerned, this means the procedure under the Department of Commerce.

Very respectfully,  
Sgt. E. B. Woodcock,  
Commander U. S. Navy,  
Assistant Director Naval Communications

---

## COMING!

The Biggest Boom in Amateur Radio History.

**AMATEURS:** Order your apparatus and get your licenses!  
**MANUFACTURERS & DEALERS:** Tell us what you have!  
**NON-SUBSCRIBERS:** Get in your QST subscription  
At Once - Immediately - To-day - Now!

# WE'RE OFF!

The picture of the situation was literal. An immediate headlong rush to get on the air took place. Manufacturers were hard put to supply apparatus fast enough. Each night saw additional dozens of stations joyously crashing out over the air.

*Gangway!  
King Spark!*

*Grown now to full maturity, developed and perfected by years of pre-war and war experience, it reached its highest peak in the succeeding eighteen months. Glorious old sparks! Night after night they boomed and echoed down the air lanes. Night after night the mighty chorus swelled, by ones, by twos, by dozens, until the crescendo thunder of their Stentor bellows shook and jarred the very Universe! A thousand voices clamored for attention. Five-hundred-cycle's high metallic ring. The resonant organ basso of the sixty-cycle "sync". The harsh resounding snarl of the straight rotary.*

*Character: Nervous, impatient sparks, hurrying petulantly. Clean-cut business-like sparks battling steadily along at a thirty-word clip. Good-natured sparks that drawled lazily and ended in a throaty chuckle as the gap coasted downhill for the sign-off*

*Survival of the fittest. Higher and higher powers were the order of the day.*

*The race was on, and devil take the hindmost.*

THE STORY of post-war amateur radio is the story of two fundamental technical developments, c.w. and short waves, and their outgrowth, international DX.

C.w. came first. It was a product of the amateur's war experience. While serving in the Army and Navy he had seen five-watt tubes covering distances of which a half-kilowatt spark would not have been ashamed. From the outset, QST boosted vacuum tube transmission.

But it was a long struggle. Although V.T. reception became universal, the familiar autodyne and one- or two-step traditional receiving practice, spark transmission reigned supreme until late in 1922. *Spark forever!* cried a horde of supporters. QSL cards — their vogue was starting about then — took up the battle cry. The air lanes rang with the thunderous echoes of the David and Goliath struggle.

It took an incontrovertible example to turn the tide.

In December, 1921, the A.R.R.L. held its second transatlantic tests. Prior to that time the British had been unable to receive American stations, so the League picked Paul Godley as the foremost receiving expert of his day, and sent him over to Scotland to listen for American signals. Setting up his receiving station in a tent at the very edge of the sea on bleak Ardrosan moor, he heard over thirty American stations, *more than two-thirds of which were using c.w.!*

It was a year before spark was generally relegated to the scrap heap, three before it sank into oblivion. But the rank and file already began to concede the fight to the slide-rule minority.

Amateur radio began upon a new era.

Secretary of Commerce Hoover announced the offer of a cup to be competed for annually by America's best all-around amateur stations.



IN GODLEY'S TENT, ON THE SHORES OF SCOTLAND



Amateur police radio aided in recovering stolen automobiles and other property. West coast amateurs were regularly copied in Hawaii during the winter. The A.R.R.L. represented amateur



WARNER, SCHNELL AND MAXIM LISTENING TO THE TRANSATLANTIC RETURNS, 1922

radio at the First National Radio Conference. Forty states presented messages of congratulation to President Harding in the A.R.R.L. governors-president relay. Congress busied itself with the Kellogg-White bill; it failed to provide for amateur rights, and was eventually defeated. At the end of the fiscal year in 1922 there were 15,504 licensed amateur stations.

The year 1922 ended with a bang. Ninety-one stations were heard in Europe during the preliminaries to the transatlantic tests. A message was sent 10,000 miles in four minutes, from Hartford to Hawaii and back with one intermediate relay. Seventy eight stations were heard at more than 3000 miles on a ship crossing the Pacific. Daylight transcons were a partial success. A snowstorm emergency found amateurs on the job.

Throughout England and France listening enthusiasts glue on their headphones, squeeze the last atom of regeneration from their detectors, burn their filaments at a reckless glow. From across the sea come signals, hundreds of them, from all over the United States and Canada — 315 stations rending the European ether with frantic calls. The third transatlantics are a glorious success!

THE YEAR 1923 rolled in on a tide of wild enthusiasm. Hardly had it opened when New Zealand amateurs reported logging stations from every district in the United States. In midsummer came reports from Australia that they were hearing American amateur stations from all but the eastern districts. Coincident with these reports came word that several ships in Chinese and Japanese waters had logged west-coast amateurs. MacMillan went to the Arctic, and with him on the *Bowdoin* the League sent Don Mix and a transmitter to carry on amateur

work from the Far North. QST began talking about short waves. But there was little interest. Yet amateurs clung to 200 meters. It took another startling example to again turn the tide — this time transatlantic two-way communication.

The evening of November 27, 1923. Fred Schnell, the A.R.R.L.'s traffic manager, is at the receiver of 1MO, with Maxim and Warner as witnesses. At ten p.m. Leon Deloy, 8AB, after a summer of preparation including a trip to this country, is to call them from Nice, France. New Reinartz circuits are in use at both ends. At the appointed hour Deloy's rough, throaty gargle fills the 'phones. They reply. The Atlantic has been conquered by two-way amateur communication for the first time in history!

BUT even more significant was the wavelength used: 110 meters. Other stations, using similarly short waves under special government permission, were equally successful.

That was the start. Before a month was out five countries were in contact — England, France, Holland, Canada, U. S. A. A list of international intermediates was evolved, to identify stations of various nationalities.

In Australia, 2CM worked 1500 miles to New Zealand with 0.004 watt. President Coolidge sent Christmas greetings to MacMillan at the North Pole. PRR — the amateur emergency network for the Pennsylvania railroad got under way. In January, Italy joined the international DX list. Short waves again were the vehicle — 114 meters. In February northwestern amateurs did heroic emergency service when a blizzard paralyzed the country.

"The radio bills that bloom in the spring," said QST, commenting on the 1924 White Bill. The A.R.R.L. had had a long and varied experience in legislative matters by now. Although supported by A.T.& T. and R.C.A., but a danger to amateur radio, this bill, too, was

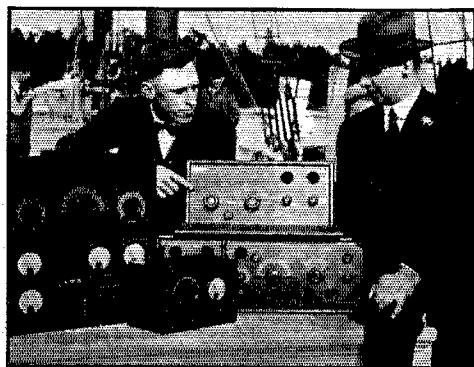

DON MIX, COMMANDER MACMILLAN, AND WNP, 1923

successfully opposed. Meanwhile, Hiram Percy Maxim was being tendered a dinner by Europe's most distinguished radio men at the Hotel Lutetia in Paris. It was from this meeting that the International Amateur Radio Union grew.

A daylight transcon — without relays! On May 22d the world's DX record went to Argentina and New Zealand, 5400 miles. Superheterodynes — that worked, they said.

July 24th . . . short-wave bands open to all. Prior to this time only experimental stations had been able to operate outside the regular 150–200 meter amateur band. Now the Commissioner of Navigation announced the opening up of wide additional territory at 5, 20, 40 and 80 meters, for c.w. operation only. This was achieved at the Fourth National Radio Conference, after more than a year's work on the part of the League.

The *Bowdoin* returned September 20th, after a year and four months in the Arctic. MacMillan was loud in his praise of amateur radio; never again did he venture into the North without an amateur operator and his station aboard. Single-control receivers. The Antipodes linked by amateur radio — New Zealand and England. No more new DX records. The world had been girdled!

The winter of 1924 and 1925 saw world-wide amateur radio an actual fact. Almost nightly, it seemed, new countries came on the air. Most of the work was in the vicinity of 80 and 100 meters. The Navy Department requested the coöperation of the A.R.R.L. in organizing the Naval Radio Reserve. A group of experimenters continued on the downward trek, achieving daylight DX on 20 meters. The A.R.R.L. arranged eclipse tests in conjunction with the Naval Research Laboratory.

In the April, 1925 issue of *QST* John Reinartz first propounded the reflecting ionized layer hypothesis to account for the behaviour of short waves. Fred Schnell, traffic manager of the A.R.R.L., sailed from San Francisco on the U.S.S. *Seattle* to demonstrate short waves to the Navy. During his seven months' cruise he repeatedly outperformed all other means of radio communication with his comparatively low-powered high-frequency equipment, inaugurating the Navy's leadership in short-wave development which has been maintained since that time. A few experimenters struggled diligently with 5 meters, but achieved no satisfying results.

The scene is the *Faculte des Sciences*, Paris, in mid-April, 1925. Delegates from twenty-three nations — the A.R.R.L. representing the United States — have convened in the First

International Amateur Congress. The constitutional committee presents its recommendations. On April 17, 1925, the International Amateur Radio Union is formed. Maxim is elected president; Warner secretary. Amateur radio officially achieves an international status.

THE ANTIPODES were linked in daylight on 20 meters, as if in celebration of the event, when England worked Australia — and American amateurs hastened to duplicate the feat. In August the Army-Amateur affiliation got under



THE FIRST INTERNATIONAL AMATEUR CONGRESS, 1925

way, with a request for the coöperation of the A.R.R.L. from the Chief Signal Officer. Autumn brought the practical ham use of a new and intriguing development — crystal control.

And on it went. Amateur radio, guided by powerful national and international organizations, swept on to ever new achievements. Expedition after expedition went into the hinterlands, and the interrupted musical chime of their signals to amateurs in the farway homeland carried tidings of their derring-do. Storm and flood and hurricane and Acts of God struck down humans and their puny structures, and amateur radio bridged the gap of holocaust to bring intelligence and relief and aid. A hundred and more expeditions, utilizing amateur communication. Two score major emergencies, with amateurs stepping in the breach. Thousands of friendly messages a year, handled gratis for the public. Public service — freely given, without recompense, unselfishly — yet withal a source of pure joy to the thousands of giving hams. Payment? Yes, they were paid — not in money, but in the unsurpassed thrill of achievement and service.

So they flourished, in numbers and in the equal triumphs of technical advance and public service. From 15,000 licensed stations in 1922 to 30,000 in 1932, and again to 45,000 in 1934. From a small group of barely-tolerated experi-

menters in attic workshops to the most powerful and respected single group in the radio world.

Three decades. The first, birth and infancy. The second, adolescence and recognition. The third, maturity and achievement. No "rags to riches" romance, but a hard life, a perpetual struggle. There were many enemies, jealous and envious and often frankly acquisitive. Even yet, danger dogs the career of amateur radio.

**L**EGISLATION has always been the arch enemy of the amateur. It is now an old and oft-told story that but for human erring on the part of the first radio law makers of 1912, who consigned the amateur to the "useless" low-wave 200-meter region, the first encounter with this formidable antagonist would very likely have ended in virtual extinction.

With the coming of the A.R.R.L. upon the scene, amateur radio had a champion to fight its cause. In ten years a dozen serious legislative threats were successfully combatted, as the growth of other radio interests engendered jealousy of amateur territory. Yet instead of losing territory, amateur radio gained new and valuable bands. The last of the National Radio Conferences, November 4, 1925, removed the final threat of broadcasting against amateur radio. A menace of another kind put in its appearance during 1926 and 1927 — attempts on the part of municipalities to regulate the local amateur operation. For six months the League battled in the Courts of two states, and in 1927 obtained court opinions denying municipalities the right to interfere with amateur operation. A new radio law was passed in 1927; its provisions proved that the American amateur was a recognized institution, here to stay.

But internationally the situation was different. During the autumn of 1927 delegates of most of the nations of the world met in Washington to draw up a new international radio treaty. The most powerful nations on earth endeavored to have amateur stations forever abolished. Only sustained effort on the part of League representatives, backed by the splendid support of the U. S. government delegation, made it possible to emerge from that conference with the rights amateur radio possesses today. New regulations, in conformity with the international treaty, went into effect on January 1, 1929.

From 1929 until the present day the star of amateur radio has been fixed. There have been threats against existence, both domestic and international, but watchful intervention on the part of A.R.R.L. officials have prevented these threats from reflecting upon the day-to-day operation of the amateur. Two major revisions of the amateur regulations have been made, both embodying the result of recommendations by the A.R.R.L.'s board, and both hailed by the

rank and file of amateur radio as resulting in improved operating conditions.

It is not possible to detail the number of times in which A.R.R.L. officials have operated to protect amateur interests since 1929. Four international conferences, half a dozen domestic radio bills introduced in Congress, with hearings and memoranda and investigation, hundreds of conferences with members of the Federal Radio Commission and its staff — the importance of all these is so great that the secretary of the League commonly visits Washington at least every other week, spends half his time in connection with regulatory matters, in addition to the watchfulness and activity maintained by the vice-president and general counsel.

Meanwhile, amateur radio, its orbit stabilized, has proceeded to perfect itself. It is impossible to outline even the broad trends along which it has progressed in the allowable paragraph or two which can be allotted for modern times in this résumé. Elsewhere in this issue is a record of technical progress, into which there is no need to trespass. One is bowed down with a sense of futility at the enormity of the task, in attempting to visualize the scene. Every objective of twenty years ago has been realized. True, in their stead new objectives have risen, which must be realized in the coming twenty years.

The highlights of 1934 contrast strangely with the highlights of 1914.

One can sketch, with a few broad strokes. . .

*1934: Forty-five thousand licensed stations — thirty-five thousand operators . . . thirty percent of them active at any one time . . . their activity spread over six bands with ranges from a few miles to world-wide . . . nothing remaining impossible of accomplishment within terrestrial limits . . . international DX a routine occurrence . . . the congestion of incredible numbers foiled through unbelievable technical progress . . . point selectivity realized in receiving practice: a literal single signal . . . stable ultimate transmission on any of the six bands with a new minimum of apparatus and adjustment . . . operating technique refined and developed through the experience of twenty years of organized relaying . . . a swell bunch of old timers . . . an eager group of beginners . . . a large mass of genuine hams . . . a watchful and wise organization . . . Utopia? . . . Well, hardly . . . human nature, nor circumstances, make Utopia a never-to-be-realized state . . . yet amateur radio is as near to riding the top o' the world as anything can be on this earth.*

*A toast and a prayer for its continued rise. Here's to Amateur Radio, through the years to come!*

— C. B. DeSoto

# A SKETCH OF TECHNICAL PROGRESS

WE HAVE had a grand time running through all the old *QST*'s in the attempt to glean material for a review of the progress of ham equipment down through the last twenty years. The original idea was to make notes on all important technical contributions—a half-day task—then to dash off a list of technical highlights. Dead simple. . . . We finished up by spending several days and a week of evenings in an orgy of reading, consuming almost everything from the first cover of the first issue on, and making enough notes to form the basis of a couple of fat volumes.

But now that the reading is finished, it seems quite futile to attempt to write the story of the development of ham radio technique without having an entire book to write it in. The only remaining hope is that under these circumstances it should still be possible to touch off a few highlights of the past—things that can be looked back at now with a great deal of pleasure and possibly some profit.

## The Ultimate?

Quite the most significant thing about ham radio of 1914 was the very grand and glorious feeling of technical security that seems to have existed. Young amateurs installed spark coils and fixed gaps. More ambitious fellows put in a half-kilowatt transformer and rotary gap. When they did that and when they topped it off with the highest, widest and handsomest antenna and the most elaborate possible ground system, they had the very last word in a transmitter. Nothing more could be done outside an increase of power. We still have the same ideas to-day, of course. We still are prone to think our Tri-tet crystal transmitters and S.S. receivers the ultimate. But the history of the game has taught us to maintain a healthy degree of doubt in our minds at all times.

Judging from the literature of the day, the ham of 1914 was cock-sure of his equipment. The ultimate had arrived. It is not surprising, therefore, that the technique had fallen into a condition of complete stagnation.

The early *QST* made no conscious attempt to inspire technical progress. It set out to be simply a journal devoted to the business of reporting amateur activity and maintaining well-organized relaying. Even so, its influence on technique was immediate. The publication of station descriptions and performance details made apparent the wide differences in results obtained by different workers with similar equipment. Within a year the rusty gears of technical progress had been oiled into working condition.

*QST*'s first real job in the technical field was to provide information on how to build and oper-

ate vacuum tube receivers. Prior to December, 1916, the magazine had strenuously avoided running anything in the way of "How to Make It" articles. At that time, however, in response to obvious demand, a "Construction Department" was inaugurated. "Complete Description with Instructions for Building a Short-Wave Regenerative Receiver" started the ball rolling.

At this stage of the game, the commercially manufactured equipment appears to have been far ahead of anything that the amateur could build himself.

Technical cob-webs in the amateur field had just about been cleared away when the war ban fell.

During the war years, as everyone knows, professional radio made tremendous strides. The world's radio engineering talent, one might say, waged a war of its own against the problems of radio transmission and reception. Very naturally, the post-war amateur had a big job of rebuilding on his hands.

## Spark vs C. W.

From our present point of view, it would seem that the radio amateur of those days was a bit slow on the up-take. Admittedly, there was precious little equipment available other than the transformers, condensers and gaps which had been stowed away for the war period. Even so, it was many years before amateurs generally would admit, despite *QST*'s advocacy of the new technic, that tube transmission had any real advantage over spark.

*QST* for July, 1920, carried an editorial on the c.w. vs. spark business that will bear quoting in part:

"We are very strongly in favor of c.w. transmission, and we are going to do all we can to help it along. . . . It is wonderfully efficient because the decrement is so extremely low and the energy all on practically one frequency. . . . It has its disadvantages, too, but they are temporary in character. It is awfully hard to get hold of tubes . . . it is not cheap. . . . The bulk of the expense, outside of tubes, is in the motor-generator, and we believe it will be only a short time until some enterprising amateur discovers a cheap way of getting around this. . . . We are on the eve of a great transition in amateur methods. We plead for the Undamped, the serious consideration that its many advantages merit."

But interest in spark was not to be dampened that easily. January, 1921, *QST* carried the announcement of an "Ideal Relay Spark Transmitter" contest, justified in this fashion: "We want more practical articles for the amateur who

*(Continued on page 108)*

# Two Decades

## *A Pictorial Review of*

1914-1916

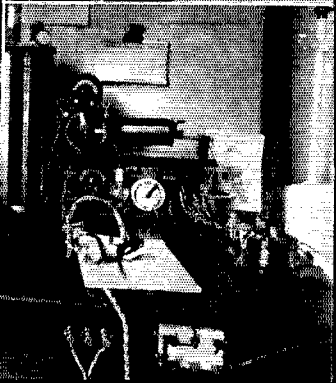
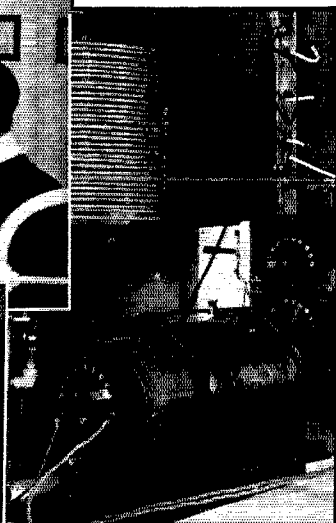
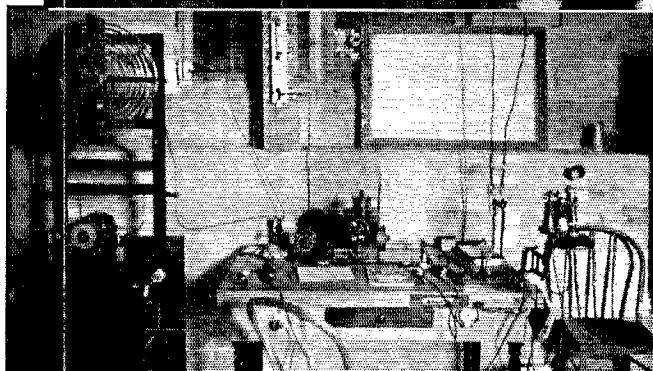
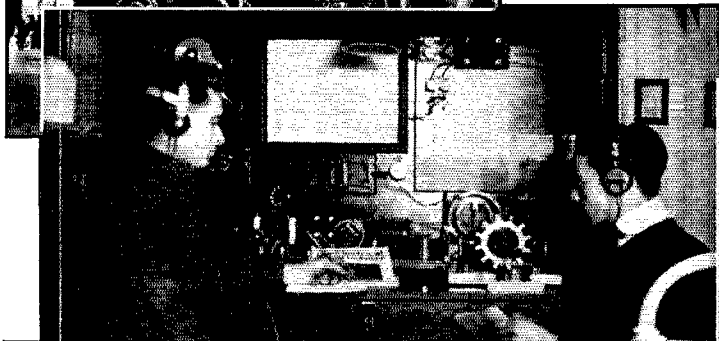

### THE PRE-WAR DAYS OF SPARK

Some typical station pictures of the days when good DX was a matter of a hundred miles. Old-timers well remember the rotary gaps, pancake transmitter inductances and loose-couplers that constituted important components in the modern station. The audion, to be seen in some of the illustrations, was the very latest thing to come down the pike. But it was a dizzy-acting gadget.



Illustrated at the top left corner of this group is the pre-war rig of the present WODAX. No dope is available on the equipment used but it would seem to be a quarter-kilowatt transformer, rotary gap and, for receiving, a dandy crystal set.

Second from the top is a clean-cut station about which, unfortunately, we have no data at all. Obviously it was an up-to-date station and a source of great pleasure to the two staid operators.

The right-hand picture of the group is a glimpse of the early station of Louis Falconi who was later to be a winner of the Hoover Cup and owner of a very famed station of post-war years—5ZA. The home-made loose-coupler with single-slide tuning of the primary is characteristic of the receiving equipment of the day.

The lower-left illustration is of 9BG, St. John, Kansas, in 1916. Fitted out with 1-kilowatt panel type spark transmitter, an advanced type of loose coupler and an audio detector, it is probably accurately representative of the best stations of that era.

The 1916 version of 3AEP is shown at the lower right. The equipment includes a ½ kilowatt transformer providing 14,000 volts; eight sections of Murdock condenser and a Hy-Tone rotary gap. An audion was available for reception but Crystalol and Perikon detectors served for most of the work. A six-wire antenna 70 feet high completed the station.

# of Progress in Station Equipment

## Miscellaneous Ham Apparatus — Old and Not So Old

**I**N SELECTING these photographs, our chief idea has been to present stations to some degree typical of the period in which they were built. Our selections (handicapped by an inadequate file of historical photographs) were not based on the importance of the stations in their day or on the elaborateness of the equipment—hence the hodge-podge. It is quite obvious that had we chosen the most famed stations or those most noted for their completeness, it would have been a different showing.

### POST-WAR SPARK AND EARLY C.W. STATIONS

Top left: 2JU in 1920, rather badly chopped up by the engraver. Note the Grebe regenerative tuner and two-step amplifier. The transmitter was a spark of 1 kw. or thereabouts.

Top right: The hefty spark transmitter of 3CG in 1921.

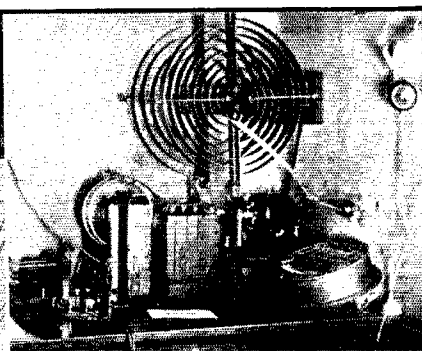
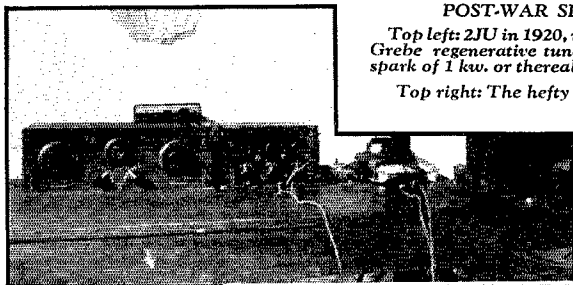

1918-1922

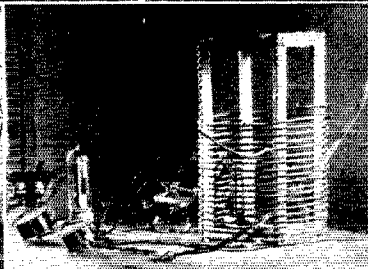
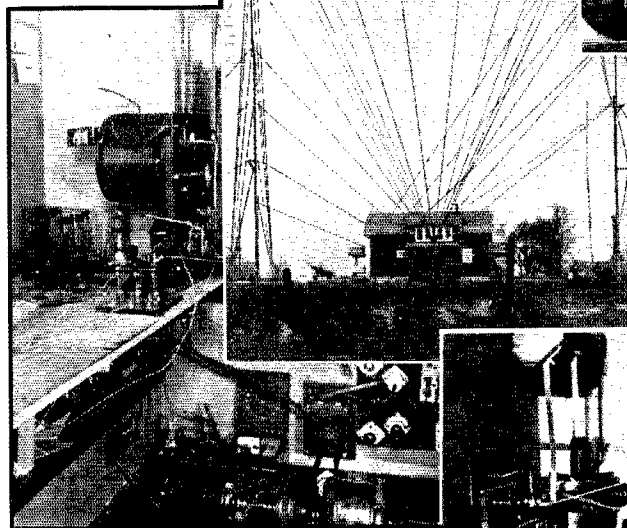

Center: 8ML built an antenna in 1921—this is it. The masts were only 110 feet high.

Right center: 8DE's c.w. rig of 1921 looks a bit temporary but it gave his spark set a big licking.

Lower left: 1RU's early c.w. set, successful in the December 1921 Transatlantics.

Lower right: 9ZX-9EE of the vintage 1922. Note the dandy little tube set stuck on the corner of the table for a try-out against the spark. And note the chem. rectifier.

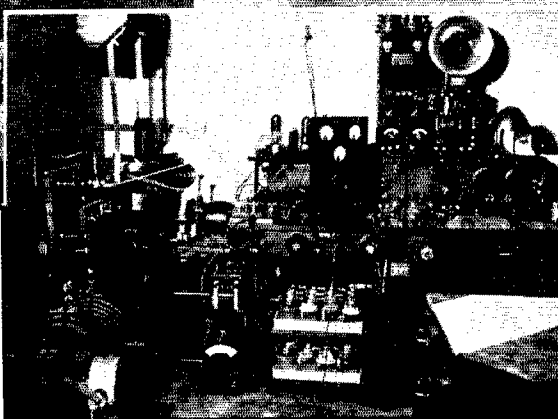

# Further Stages in *C.W. Wins over Spark—The*

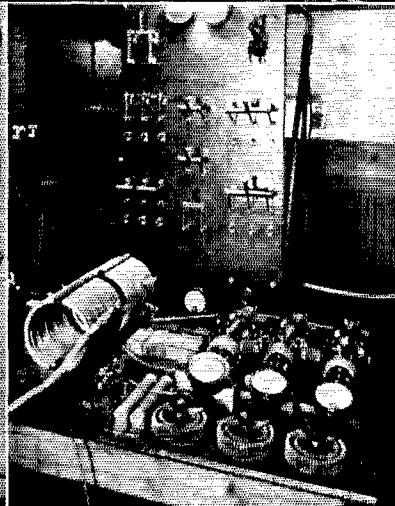
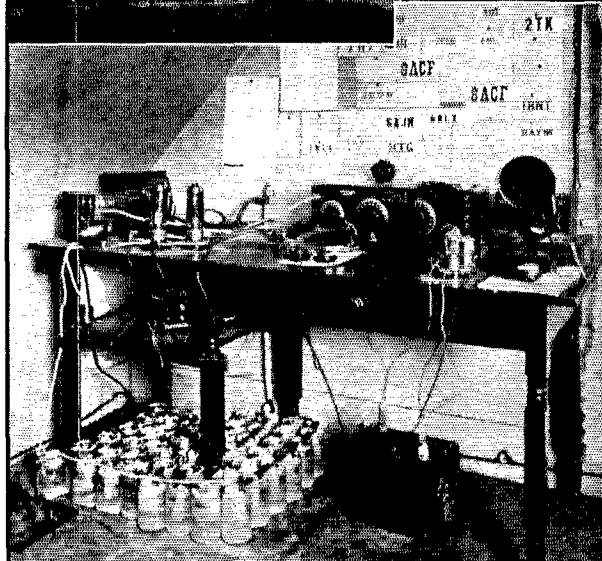
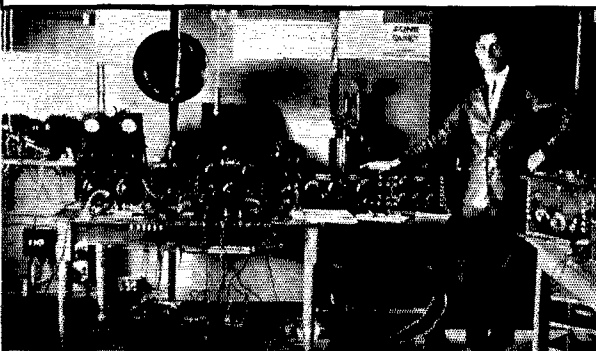
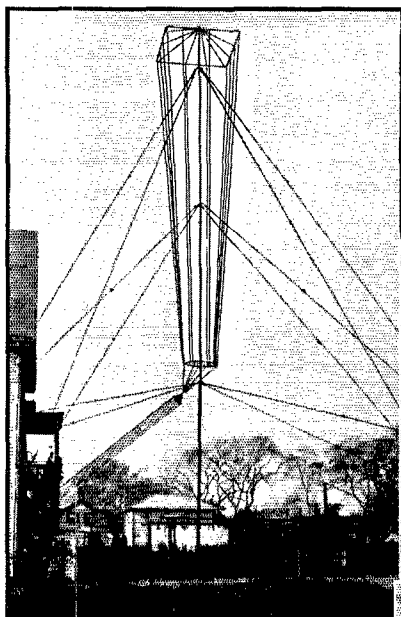

## 1923-1925

### C.W. COMES INTO ITS OWN

*Top left: The era of high-capacity top antenna must have started when IAFV put up this unique affair in 1922. Such antennas, with endless variations, appeared in all parts of the world.*

*Top right: 5ADZ's complex layout in the early c.w. days.*

*Lower left: 8ATU—a truly characteristic rig of 1923-24.*

*Right center: Portion of the beautiful experimental station 8AQO in 1924.*

*Lower right: 9ZN's high-powered c.w. station in 1923. Mathews (see Hamdom) was its owner.*





# Amateur Station Development

## *Atlantic is Conquered—Amateur Signals Cover the World*

**B**Y THE YEAR 1925, a period of vigorous technical advance had set in. Crystal-control had been shown to be perfectly practical and highly desirable in the amateur station and a hundred and one minor changes had been shown to be worthwhile. From this time on, it is no longer possible to provide more than the merest suggestion of the type of equipment used.

*Top left: Hardly a typical average amateur transmitter—the high powered crystal-control set built by 9UZ in 1926.*

*Top center: G20D and his receiving equipment in 1925. The station became famous for its solid signals the world over in the early years of international DX on 40 and 20 meters.*

*Top right: Australian 2CM in early 1925. Using a 204 and chemical rectifier, this station did much stunning DX in this same period. 2CM was noted also for extraordinary transmission over distances up to 1500 miles with power of a few hundredths of a watt.*

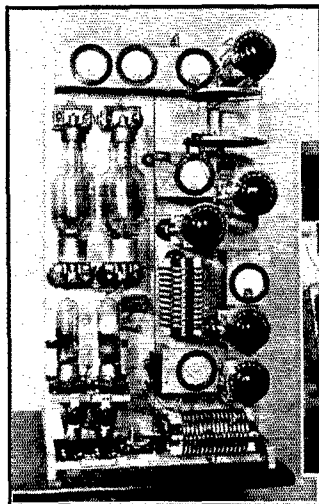

1925–1930

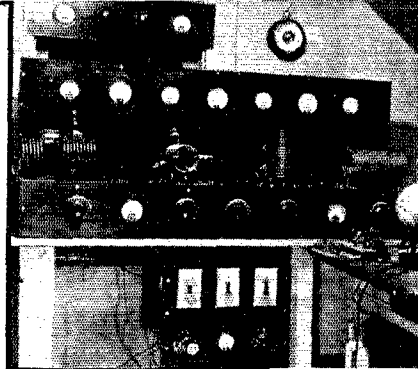
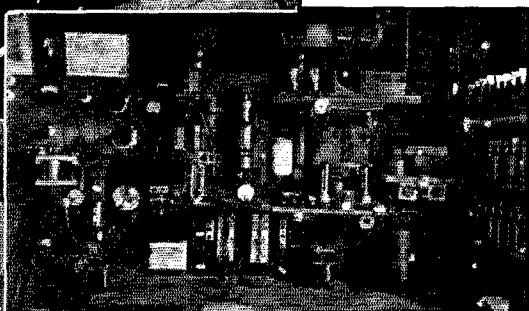

*Lower left: W9DXP in 1930. Crystal-control, by this time, was fast becoming universal. This three-band transmitter with an 852 in the final amplifier is a good example of the ideal of the day. The receiver was a four-tube s.g.-peaked audio affair.*

*Lower right: If crystal-control was not available, the self-excited transmitter of this day was being given careful treatment. This is the High-C rig of W2ABE in 1930.*

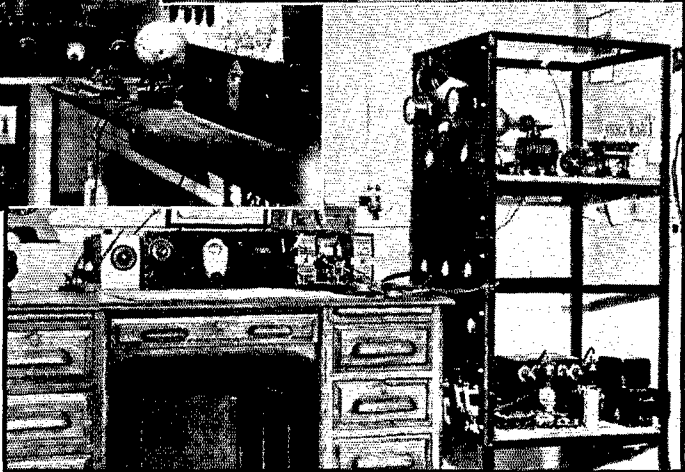

# Hamdom's Traditions

## A Bedtime Story for Young Squirts

By Rufus P. Turner, WIAY-W3CVT-W9FZN\*

**A** WEIRD woebegone implement hangs above Warner's desk at Hartford. You'd never guess what it is if you didn't already have an inkling. It appears to be equal any day to beating the brains out of King Kong. You'd swear it at first sight to be the stock of some antediluvian blunderbuss. A half-dozen acres of Manhattan rock-bed might be plowed up with it without injury to its gross lines.

If you inquired as to its name, use, and evolution, your informant would cast a stealthy glance about the chamber, even as Rasputin might on the verge of imparting a sinister secret; and being assured of privacy, would hiss in hushed monotone, "'Tis the one and only Wouff-Hong, sacred symbol of law and order in amateur radio." And you might reasonably expect to hear the crashing sound of a Chinese death gong at the next minute. Lo, the poor Indian had a word for your next question—"wo," which means whence comest and whither goest!

The Wouff-Hong came from the hands of The Old Man, the supreme sage of amateur radio. But, take it or leave it, in the beginning the bewhiskered one himself wondered what a Wouff-Hong was!

It chanced that a vehement article, denouncing interference on ham wavelengths and dripping with wrath, slipped into the January, 1917, issue of *QST*. Many a youthful ham—"young squirt," as the bellicose writer called them—shivered as he read "Rotten QRM" by The Old Man. Too, there has been much shuddering and chattering of teeth in the years that have followed; The Old Man's articles have appeared on these pages again and again, but in sixteen years of watching over ham radio and incensed writing he has not disclosed his identity.

In his first article, the Wise One called attention to word-butchered abbreviations concocted by code men which were just slipping into use.

\*1243 Kenyon St. N. Y., Washington, D. C.

The Old Man had lost out on sleep because of this and interference. The words "Wouff-Hong" and "Rettysnitch" had come through his 'phones with a mess of other semi-intelligible yield—this was food for his grouch. He—The Old Man did—asked what in the name of common sense a Wouff-Hong was!—insinuated that it sounded like something with which monkeys are beaten in the southern states.

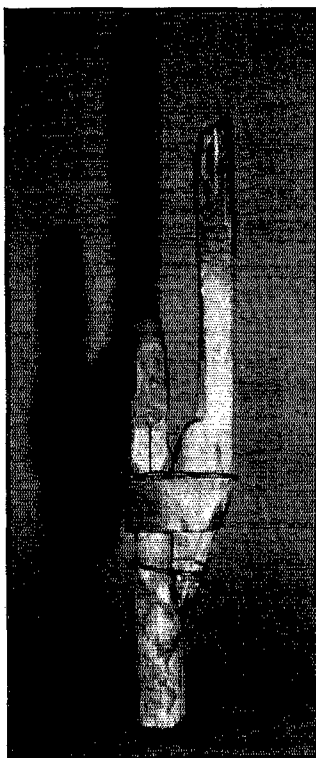

The effect of his interrogation was magic. There was much speculation as to the meaning of the word throughout the Land, yea, in all nine districts. One letter writer, signing himself "A Loyal League Member," declared in the August, 1917, *QST*, that he knew what a Wouff-Hong was and had chained the animal to his receiver to gobble up static and broad signals. His recommendation was enthusiastic. Immediately, Tuska, *QST*'s editor, was besieged with orders for Wouff-Hongs that could not be filled.

Came the Great War, and all hams who could not disport flat feet or floating kidneys forgot all about Wouff-Hongs and the like and joined up with the armed signal forces. Your Uncle Samuel down at Washington closed down all ham stations, and *QST* suspended publication.

When hostilities ceased and the League Directors met to lay plans for reconstruction, Warner, unoustachioed Army lieutenant, came over from Illinois to fill the editorial chair left vacant by Tuska. At the meeting a package addressed to the editor was presented. Out of the wrapping bounced the gruesome instrument of torture that to this day has hung in the sanctum of the Secretary-Editor's office occupied to this day by the same Warner. The terrible thing was sent in by The Old Man, who described it in a letter as "an absolutely authoritative and well-preserved specimen of Wouff-Hong." The Board charged that it be kept forever in the editor's office within easy

(Continued on page 122)

# AMATEUR RADIO MARCHES ON!

WIC:10

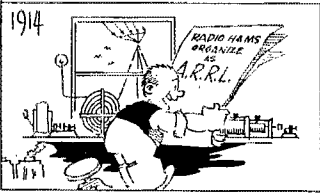

1914



1915 THE AUDION GETS DOWN TO WORK

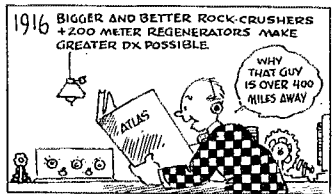

1916 BIGGER AND BETTER ROCK-CRUSHERS + ZOO METER REGENERATORS MAKE GREATER DX POSSIBLE



1917

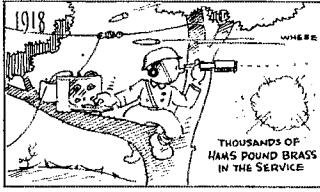

1918



1919

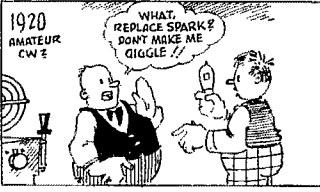

1920 AMATEUR CW'S



1921

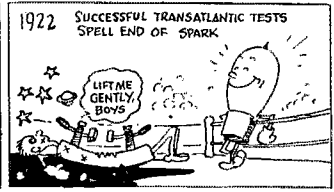

1922 SUCCESSFUL TRANSATLANTIC TESTS SPELL END OF SPARK



1923 INTERNATIONAL SHORT-WAVE DX!!

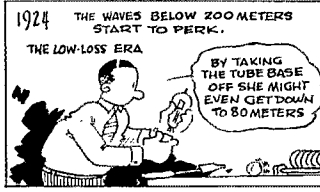

1924 THE WAVES BELOW 200 METERS START TO PERK. THE LOW-LOSS ERA

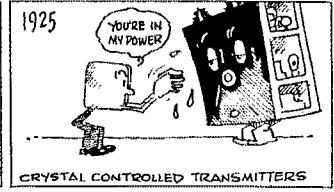

1925

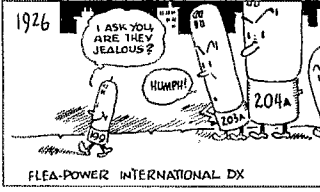

1926

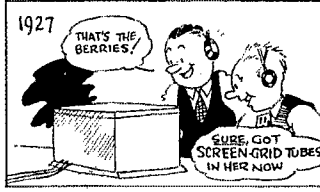

1927

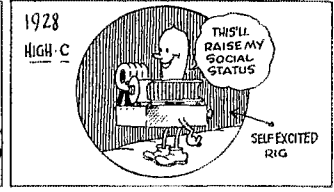

1928 HIGH-C

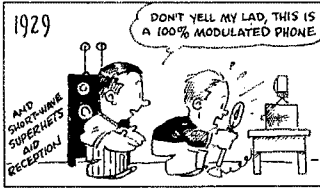

1929

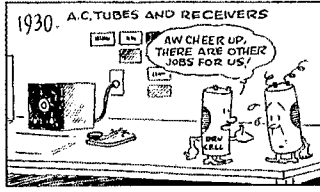

1930 A.C. TUBES AND RECEIVERS

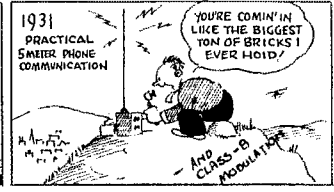

1931 PRACTICAL 5WATER PHONE COMMUNICATION

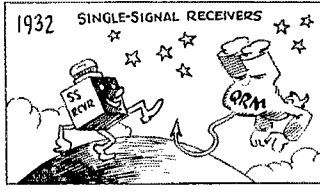

1932

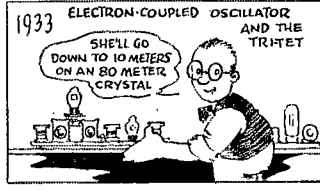

1933

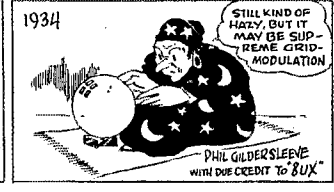

1934

# Suppressor-Grid Modulation in the Low-Power 160-Meter 'Phone

## Construction and Operation of a 5- to 10-Watt Crystal-Controlled Outfit

By Don H. Mix, WITS\*

**I**N SPITE of the great quantity of material which has been published from time to time on "simple" radiotelephone transmitters, the fact has still remained that, when compared to an ordinary code transmitter, the 'phone outfit has been a pretty complicated piece of apparatus. Altogether too many possibilities for improper operation and adjustment have existed to allow the term "simple" to be used in more than a comparative sense.

Jim Lamb's recent investigation<sup>1</sup> of suppressor grid modulation, however, has opened up a new field of possibilities for the radiotelephone trans-

mitter capable of proper operation with wide tolerances in adjustment and simplicity in construction. These features were indicated in the original article and have made themselves very evident in the subsequent construction of a complete transmitter.

A glance at the circuit diagram should dispel any possible fear of complication that might be suggested by a system having such an imposing title. The oscillator is the now well-known tri-tet crystal-controlled circuit using an ordinary screen-grid receiving tube, the '24-A. This is followed directly by the modulated output amplifier using a pair of 59's in parallel. To most of us, accustomed to a relatively large layout for the audio equipment, the modulator is especially interesting. As the diagram shows, it is nothing more than a single stage of ordinary audio amplification such as might be used following the detector of a receiver or as a speech amplifier preceding the usual modulator. The power supply included in the transmitter will be recognized as identical to that described in *How To Become a Radio Amateur*, and in the latest edition of the Handbook, for the beginners' c.w. transmitter.

### ASSEMBLY DETAILS

The two photographs of the complete transmitter show the general arrangement. While the construction may seem at first glance to be rather unusual—the frame has been termed everything from "glorified flowerpot" to "Westinghouse Junior"—it is, nevertheless, nothing more than the simplest sort of a rack for holding breadboard units. The frame eliminates the usual objection to breadboard construction, namely, that of requiring considerable table space. The table space required in this case is only an area of 12 inches by 9 inches, which allows the rig to be placed out of the way on even a small table. This form of construction also allows the use of sub-base wiring and the placement of various miscellaneous units in convenient positions below the surface of the board, resulting in shorter connecting wiring and a great improvement in the general appearance of the transmitter.

The method of construction of the frame and the various dimensions are shown in the sketch. Both front and back are made identical and are of

\* A.R.R.L. Technical Information Service.

<sup>1</sup> "Suppressor Grid Modulation," *QST*, March, 1934.

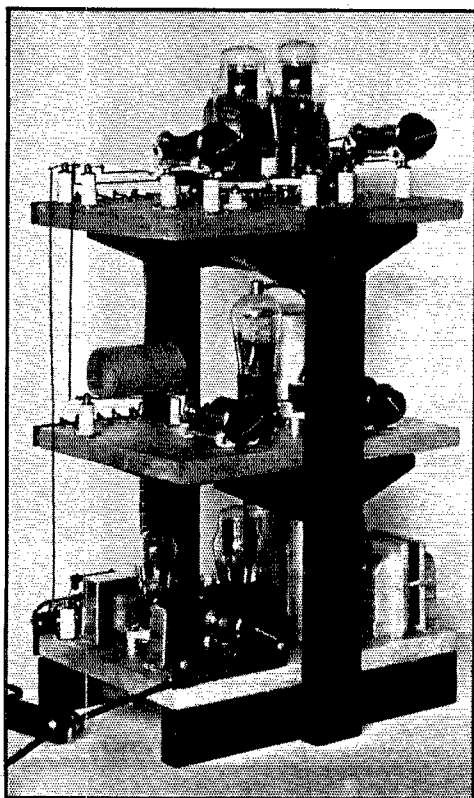

THE COMPLETE TRANSMITTER ASSEMBLY IN WHICH THE INDIVIDUAL BREADBOARD STAGES ARE EASILY REMOVABLE

standard 1-inch by 2-inch (actual dimensions slightly smaller) soft pine stock. These two sections are joined together by two horizontal connecting pieces 6½ inches long, or of correct length to space the front and back pieces to accommodate the breadboard used. The power wiring connecting the various terminals is made with "push-back" wire cabled into a more or less permanent form as shown in the rear view of the complete transmitter. The cabling of the leads in an orderly fashion with wires cut to the correct length will not only give a greatly improved appearance to the rig but also will save considerable time in connecting and disconnecting should it be necessary to remove one or more of the shelves at any time.

Each baseboard is 12 inches by 8 inches and is finished attractively with aluminum paint and a top coat of clear lacquer. The lower board contains both power supply and modulating apparatus. The various units of the power supply are easily distinguishable from the plan view of the first unit. A small bakelite panel, mounted by means of brackets made from small strips of 1/16-inch brass ½ inch wide, carries the microphone jack, the audio gain control, and the plate power cut-off switch. Directly behind this panel, in logical sequence, are the microphone transformer, the 56 modulator tube, and the audio output transformer. A strip of bakelite 5 inches by 1½ inches at the left rear edge of the board carries eleven terminals for external connections and power supply distribution to the two other units. The "high" audio terminal is brought to a stand-off insulator which may be seen near the rear of the left-hand edge of the board and is located so as to come in line with a corresponding post on the top shelf. All wiring is carried underneath the board and is done in straight point-to-point fashion with number 20 "push-back" wire. The two audio by-pass condensers and the 56 cathode resistor are also mounted underneath the board.

The second shelf contains the crystal oscillator. There may be some wonder why the tri-tet oscillator was chosen in preference to the simpler triode or pentode. The reason is that the tri-tet oscillator provides sufficient buffer action between the modulated amplifier and the frequency determining circuit to permit the elimination of the usual intermediate buffer stage. It also offers the possibility of frequency-doubling 80-meter operation without change of coils or crystals or the addition of frequency doubling apparatus.

The plan view of the oscillator shows the location of the various units. Care should be taken to isolate the grid and plate circuits as completely as possible. In this connection it might be found advisable with some types of 24-A's to rearrange the apparatus slightly so that the crystal holder may be mounted between the tube socket and the cathode circuit tuning condenser. This was not

found necessary with the first oscillator tube tried, although several other tubes tried later tended to oscillate as tetrodes when the cathode tank circuit was short-circuited, showing that the isolation between grid and plate circuits was not sufficient. Moving the crystal mounting farther from the plate circuit cured this.

The cathode circuit coil is mounted in the shielding can which is a National type B30 with mounting base. Since parallel plate feed is used, it is permissible to mount the tuning condensers directly upon the partially-conductive aluminum-painted baseboard without insulation. All power supply wiring and most of the low-potential r.f. wiring is carried under the board, and the few remaining high-potential r.f. connections are run in direct lines between the units. No. 14 enameled wire is used for this purpose. The screen and filament by-pass condensers are also mounted out of the way underneath the board. The one fixed condenser showing in the photograph is the plate blocking condenser. The grid leak is of the very small midget type and is soldered across the crystal terminals underneath the crystal mount-

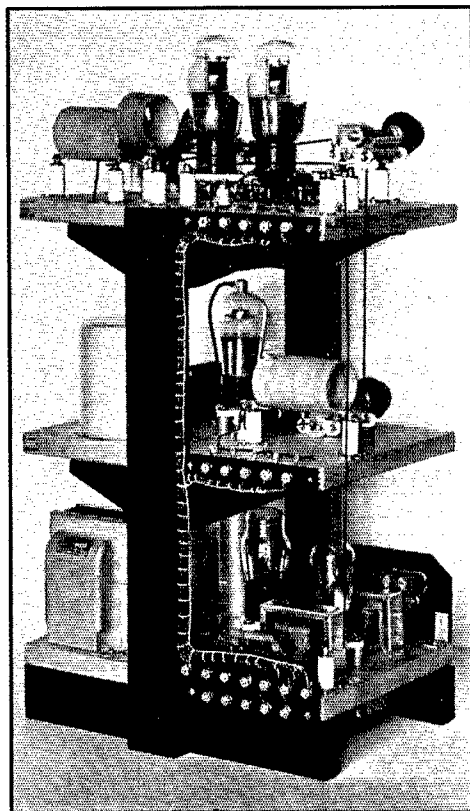

A REAR VIEW

The power wiring is cabled with ordinary string or stout thread.

ing. A stand-off insulator at the left-hand edge is provided for the high potential feed lead to the output amplifier. A bakelite strip 5 inches by  $\frac{3}{4}$  inch, with the five necessary terminals, is mounted on the left-hand edge of the board.

The output amplifier is the third and last unit on the top shelf. The general arrangement of parts is shown in the plan view photograph. As in the preceding units, the low potential and power wiring is carried underneath the board, as is also the wiring connecting the two sockets in parallel. The screen and suppressor by-pass condensers are mounted near the tube terminals below the surface of the board. Of the two fixed condensers showing above the base, the one to the left is the oscillator-to-grid feed condenser and the one at the right is the plate blocking condenser. The

left-hand r.f. choke is the control grid choke, the one near the center is the suppressor-grid choke and the one to the right is the plate feed choke.

Since the plate-grid capacity of the Type 59 tube is so small, none of the ordinary midget condensers is suitable for neutralizing. The special one shown in the photograph and the sketch may be made up in a few minutes from scraps of strip metal. The two angle pieces are identical except that one is drilled and tapped for an 8-32 flat head screw. The one-inch diameter brass disk is soldered to the head of this screw and the insulating knob, taken from an old dry battery, serves as the control on the other end. The capacity of the neutralizing condenser is varied by screwing the disk backwards and forwards in relation to the vertical stationary piece. The important

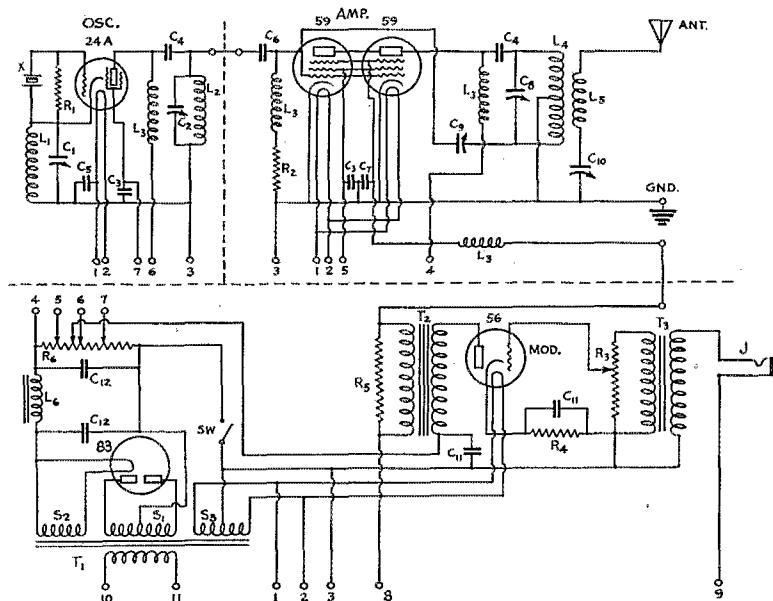

FIG. 1—COMPLETE CIRCUIT OF THE SUPPRESSOR-GRID-MODULATED 'PHONE

- L<sub>1</sub>—Oscillator cathode circuit inductance—see text.
- L<sub>2</sub>—Oscillator plate inductance—see text.
- L<sub>3</sub>—R.f. chokes (National Type 100).
- L<sub>4</sub>—Amplifier plate circuit inductance—see text.
- L<sub>5</sub>—Antenna coupling coil—see text.
- L<sub>6</sub>—Filter choke, 20- to 30-henry 100-ma. (Collins).
- C<sub>1</sub>—Oscillator cathode circuit tuning condenser—320- $\mu$ fd. midget (Hammarlund MC-325M).
- C<sub>2</sub>—Oscillator output tuning condenser, 260- $\mu$ fd. midget (Hammarlund MC-250M).
- C<sub>3</sub>—0.005- $\mu$ fd. by-pass condensers (mica receiving type).
- C<sub>4</sub>—0.005- $\mu$ fd. plate blocking condensers (mica receiving type).
- C<sub>5</sub>—0.01- $\mu$ fd. oscillator filament by-pass condenser (mica receiving type).
- C<sub>6</sub>—250- $\mu$ fd. r.f. coupling condenser (mica receiving type).
- C<sub>7</sub>—0.001- $\mu$ fd. suppressor-grid by-pass condenser (mica receiving type).
- C<sub>8</sub>—Amplifier tuning condenser, 260- $\mu$ fd. midget (Hammarlund MC-250M).
- C<sub>9</sub>—Neutralizing condenser—see text.
- C<sub>10</sub>—Antenna tuning condenser, 260- $\mu$ fd. midget (Hammarlund MC-250M).

- C<sub>11</sub>—Cathode and plate by-pass condenser, double unit, 0.5- $\mu$ fd. per section, paper type, 250-volt rating.
- C<sub>12</sub>—Filter condensers, 8- $\mu$ fd. (Sprague Electrolytic).
- J—Microphone jack, open circuit type.
- R<sub>1</sub>—Oscillator grid leak, 50,000-ohm 1-watt.
- R<sub>2</sub>—Amplifier grid leak, 25,000-ohm 1-watt.
- R<sub>3</sub>—Speech amplifier gain control, 100,000-ohm potentiometer (Centralab).
- R<sub>4</sub>—Speech amplifier cathode resistance, 2700-ohm 1-watt.
- R<sub>5</sub>—Speech amplifier load-stabilizing resistance, 25,000-ohm 1-watt.
- R<sub>6</sub>—Voltage divider, 25,000 ohms total resistance, tapped every 2500 ohms.
- SW—Plate voltage cut-off switch, single-pole panel type.
- T<sub>1</sub>—Power transformer. High-voltage winding, S<sub>1</sub>, 350 volts each side of center; rectifier filament winding, S<sub>2</sub>, 5 volts; radio tube filament winding, S<sub>3</sub>, 2.5 volts (Collins).
- T<sub>2</sub>—Speech amplifier output transformer, ratio 1-to-1 or 1-to-2 (Kenyon KA36).
- T<sub>3</sub>—Single-button microphone transformer (Kenyon K5MG).
- X—Quartz crystal of frequency between 1800 and 2000 kc.

dimensions are given in the sketch.

In this unit the two tuning condensers are mounted on stand-off insulators. Since the plate tank coil has a grounded center-tap for neutralizing, this places both sides of the plate tuning condenser at high r.f. potential. For this reason it is not advisable to mount the tuning condenser directly upon the baseboard unless it has no finish at all or has been coated with some sort of finishing preparation known to be a good r.f. insulator. Ordinary paints and enamels will not qualify for this classification.

The two stand-off insulators along the left-hand edge of the board are for audio and r.f. excitation and are so placed that connections may be made between them and the corresponding terminals of the two lower units with straight vertical wires. The terminal strip for this unit is similar to that provided for the oscillator unit.

The terminals with similar numbers should be connected together. Terminals Nos. 1 and 2 are for filament. Positive suppressor bias, positive microphone battery and ground should be connected to terminals No. 3. Terminal No. 4 is for positive amplifier plate voltage, No. 5 for positive amplifier screen voltage, No. 6 for positive oscillator plate voltage, No. 7 for positive oscillator screen voltage, No. 8 for negative suppressor grid bias voltage, and No. 9 for negative microphone battery. Terminals Nos. 10 and 11 are for the 110 volt a.c. supply. In lieu of the last two terminals, a twisted-pair cord might run directly to the power transformer primary.

The coils are made in the manner described by George Grammer on page 10 of *QST* for March. A piece of sheet celluloid of the sort used for automobile window repairing is wound tightly about a standard cardboard mailing tube  $1\frac{1}{2}$  inches in diameter. Over this is wound No. 16 d.c.c. wire to a length of about 10 inches. The winding is then given two coats of "airplane dope" or clear lacquer which should be allowed to dry thoroughly. The winding and celluloid may then be removed from the mailing tube. It will usually be necessary to break or tear the mailing tube to remove it. The coil should then be cut in four sections with a knife and cutting pliers, the sections being of 50, 40, 40, and 30 turns. After cutting, the end turns should be carefully removed to reduce the coils to 42 turns for  $L_4$ , 35 turns for  $L_1$ , 35 turns for  $L_2$  and about 20 turns for  $L_5$ . As a preliminary, it is advisable to cut the coils slightly larger to allow for any possible damage to the end turns in cutting. When the coils have been reduced to their final size, the end turns should be

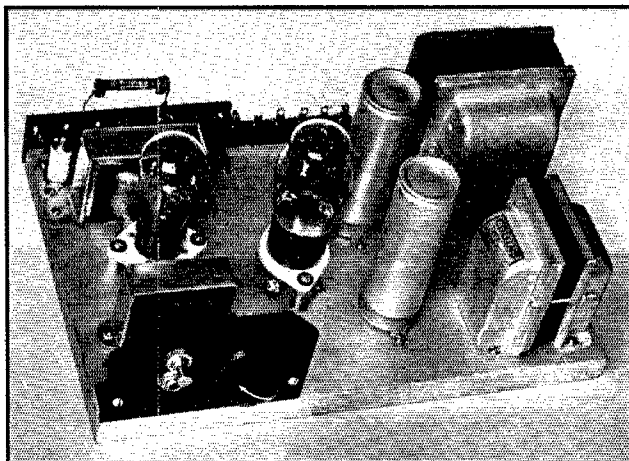

PLAN VIEW OF THE POWER SUPPLY AND AUDIO UNIT  
*The stand-off insulator at the left-rear is the audio output terminal.*

cemented in place with an additional application of the lacquer or spots of Dupont cement. The ends of the wires are bent to form small loops so that they may be mounted by means of the screws in the tops of the stand-off insulators that serve as coil mountings. The antenna coupling coil insulators are provided with a pair of small brass angles and the wire loops at the ends of the winding are bent so that they pivot on a pair of short machine screws through the brass angles.

#### TUNING ADJUSTMENTS

The tuning procedure is not at all difficult. The various electrode voltages should be adjusted to their approximate operating values first, the oscillator plate voltage being 200 to 250 volts, oscillator screen 75 to 100 volts, amplifier screen 100 to 150 volts and modulator plate 250 volts. The output voltage of the power supply shown will be about 350 volts under load; but if the additional voltage is available, plate voltages up to about 700 may be used safely on the amplifier—with proportionately greater output. The other voltages should remain unchanged at the higher amplifier plate voltage, however. If an output voltage of 350 is used with a 25,000-ohm voltage divider, the amplifier plate voltage will, of course, be taken off at the positive end. The amplifier screen voltage should be taken off at 10,000 ohms from this end, the oscillator and modulator plate voltages at 5000 ohms and the oscillator screen at 12,500 ohms from the positive end of the divider.

Preliminary adjustments should be made with the amplifier plate- and screen-voltage leads both disconnected and the suppressor-grid bias at zero. (The negative bias terminal is connected temporarily to the ground post.) It should be emphasized here that much trouble will be avoided with a good quality crystal purchased

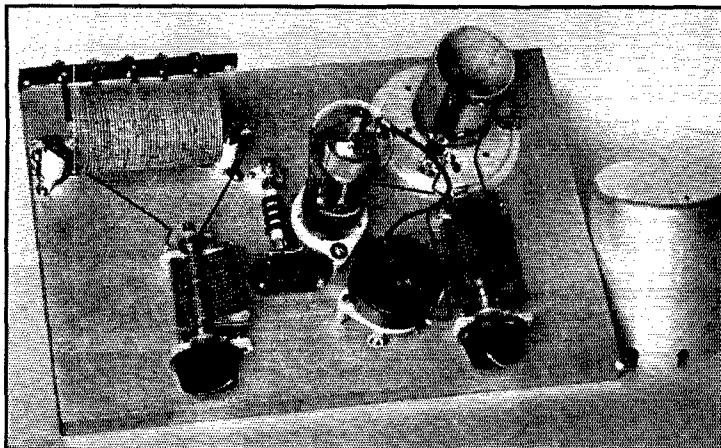

PLAN VIEW OF THE OSCILLATOR UNIT WITH THE CATHODE COIL SHIELD REMOVED

The r.f. feed lead to the amplifier is taken from the left end terminal of the plate coil.

from a reliable source. Doubtful crystals often give erratic operation, for which the usual tendency is to place the blame upon everything but the crystal. If the crystal is purchased from a reputable producer, there is also little danger of off-frequency operation with a crystal of specified frequency between the 'phone band limits of 1800 and 2000 kc. The same may be said of the oscillator tube. Don't expect an old tube taken from a broadcast receiver to give satisfactory results.

The first step in the tuning of the transmitter should be to test the oscillator for sufficient isolation between plate and grid circuits. Short-circuit the cathode circuit tuning condenser and slowly vary the plate circuit tuning condenser over its entire range, while watching the oscillator plate current indicated by a 0-10 or 0-50 d.c. milliammeter connected in the oscillator positive plate lead. If the plate current dips at any point this indicates tetrode oscillation resulting from insufficient isolation of grid and plate circuits, calling for the remedy suggested previously. When no change in plate current is obtained with plate tuning, the short should be removed from the cathode circuit condenser and all tuning condensers should be set at full capacity.

With all the tube

cathodes warmed up, the capacity of the oscillator cathode circuit condenser,  $C_1$ , should be slowly reduced until the plate current makes a pronounced dip. This dip indicates the start of oscillation and should occur with the condenser set at about 75% total capacity. The capacity should be reduced somewhat below the point at which oscillation starts but not to the extent that oscillation ceases, which would be indicated by the oscillator plate current flipping back up to its original non-oscillating value.

The capacity of the plate circuit condenser,  $C_2$ , should then be slowly reduced until another dip in the plate current occurs. At this dip, a neon bulb touched at the plate end of the circuit should indicate maximum output. Care should be taken that circuits  $L_2C_2$  and  $L_3C_3$  are not tuned to the double frequency, in the 3.5-mc. band, when tuning for 1.75 mc.-band operation. If the coils are made closely to specifications, plate current dips will occur at two points on the condenser range, one near minimum and the other near maximum capacity. The one near maximum should be the one for the 160-meter band.

The next step is that of neutralizing the amplifier. For this operation the oscillator plate and screen voltage should be off. The amplifier plate

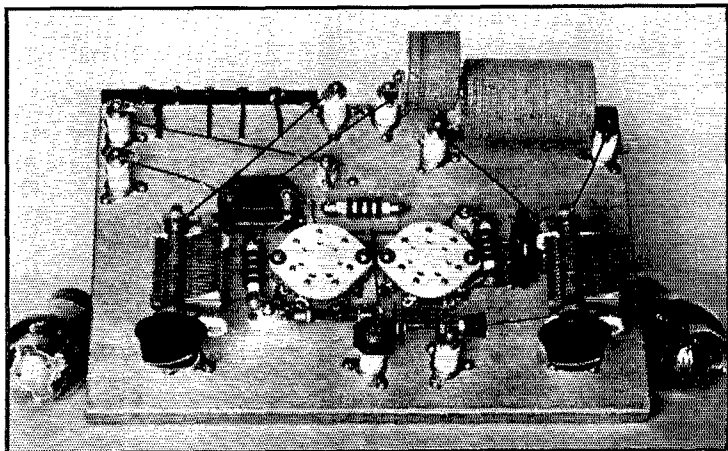

PLAN VIEW OF THE AMPLIFIER

The r.f. feed condenser between the two r.f. chokes is mounted on small stand-off insulators.



and screen voltages should now be applied. If a plate voltage higher than 350 is used, it should be reduced temporarily. Starting with the plates of the neutralizing condenser spaced about  $\frac{1}{2}$  inch, turn the movable plate slowly towards the stationary plate until the amplifier tank circuit condenser may be tuned through its entire range without any change in plate current. When the amplifier has been neutralized, the oscillator plate and screen voltages may be applied. The amplifier circuit will be tuned to resonance at the point on the tuning condenser where the plate current is at a minimum. To secure the *lowest* minimum, indicating complete resonance throughout, it will probably be necessary to go back over the first two adjustments, making slight corrections.

The antenna coupling coil is designed for use with a quarter-wave grounded antenna of about 130 feet total length, including the length of lead-

amplifier plate current does not vary smoothly as the antenna tuning condenser is varied slowly but makes a sudden jump at a certain point or shows two humps, the antenna coupling should be reduced by swinging the coupling coil backwards

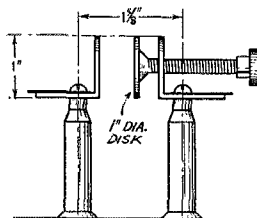

**NEUTRALIZING CONDENSER CONSTRUCTION**  
Available scrap material provided the necessary metal parts.

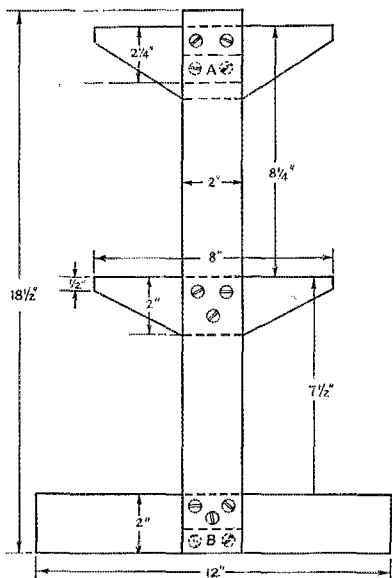

**SHOWING THE METHOD OF FRAME CONSTRUCTION**

Two identical assemblies are used for front and back. They are joined at the bottom and near the top by two  $\frac{1}{8}$ -inch strips as indicated by the dotted lines.

in and ground wire. If a shorter antenna is used, it will be necessary to insert loading by means of a coil in the antenna lead-in wire. The exact dimensions of this coil will, of course, depend upon the length of the antenna and will have to be determined experimentally.

Resonance between the antenna and amplifier output circuit will be indicated by an increase in amplifier plate current. The coupling should be adjusted to the point where there is very little difference in amplifier plate current with the amplifier tuned to resonance or off resonance. If the

until the irregular action disappears. When the transmitter is properly tuned it should be possible to tune either amplifier or antenna through resonance with a smooth change in plate current, resonance between amplifier and oscillator occurring at the point of amplifier plate current dip, and resonance between antenna and amplifier circuits occurring at maximum plate current. Plate current will run about 50 milliamperes with antenna coupled and all circuits tuned to resonance.

#### MODULATION

In most radiotelephone transmitters the real difficulty has been in the correct adjustment of the modulator and the modulated amplifier together. It is in this respect that the suppressor-grid modulated transmitter differs especially from other kinds. The following few simple adjustments are all that are necessary:

1. Note amplifier plate current with all circuits tuned to resonance and with the antenna coupled and tuned for maximum output.
2. Insert progressively larger values of negative suppressor-grid bias, by tapping along the bias battery, until this plate current becomes one-half of its maximum (zero-bias) value.
3. Connect up the microphone battery, plug in the microphone and talk.
4. Adjust the speech gain control until the amplifier plate current meter shows a barely perceptible movement at the ordinary voice level to be used. Jumps indicate overmodulation.
5. Reduce the gain control until all plate current variation with speech ceases.

Antenna current reading should not be used as an indicator of performance except to check resonance during the preliminary tuning. The higher antenna current readings obtained with suppressor bias lower than that necessary to re-

(Continued on page 180)

# A De Luxe Crystal Type S.S. Receiver

Complete Details of a Self-Powered Model With Built-in Monitor

By LeRoy Moffett, Jr., W9J1\*

A MODERN receiver that will not become obsolete by the next issue of *QST*, or by next year—that is the thing. A Single-Signal super? That is obvious. Single-dial tuning? Certainly. Easily changed coils? Front-of-panel type answers that. Power-pack and everything in one complete unit? Of course. And such modern construction as unit shielding with all the essential controls convenient for that weak DX coaxing, but with no unnecessary controls? By all means. Also, just for good measure, why not a built-in monitor? Let's have it. The circuit problems of choosing tubes for different uses, methods of coupling and de-coupling? Let's start on the circuit line-up.

## SURVEYING THE CIRCUIT

The circuit in general follows the original S.S. Super design as published in *QST*.<sup>1</sup> First, there is the pre-r.f. stage to suppress or eliminate image-frequency signals and to add its gain so the first detector can operate more efficiently on weak signals. These and many more reasons that have

greater weak signal response. With the variable-mu pre-r.f. tube taking care of the cross-modulation and handling part of the gain control, it was not deemed necessary to burden the detector with these duties. In our instance this seems to work out in practice, so the 57 wins over the 58 for first-detector.

Type 58 tubes are used in the oscillator positions. This cuts down the number of tube types required. The grounded suppressor grid connection helps to eliminate reaction between oscillator and load. A 56 second-detector was decided on rather than a 57 type, for several reasons. Its lower plate impedance simplifies the r.f. filtering in its plate circuit; it gives a better impedance match when fed directly to the 'phones, and its lower mu allows the signal and beat oscillator to be mixed in its grid circuit with less chances of trouble. The one high-gain stage of audio allows plenty of sock for the weakest DX signal; in fact, the usual noise level (the limiting factor) can be brought up to full speaker volume. Let it be noted that this is not just the set noise but also

includes that from the antenna. The rectifier uses the 80 tube rather than one of the several mercury vapor types, which are not suitable because of the "hash" troubles encountered with them.

Referring to Fig. 1, we see that the circuit is more or less standard. Paper condensers are used in many places to by-pass the r.f. and i.f., as well as audio, to ground. Trial showed that they were satisfactory where used. Generous use is made of resistors to isolate circuits. They are cheap and effective for all frequencies where their use is permissible. All suppressor grids are directly grounded to reduce electrostatic coupling between plate and grid circuits and to augment the gain control. Note that

the h.f. beat-oscillator couples into the primary of the first detector transformer  $T_2$ . This facilitates wiring.

The crystal filter circuit deviates slightly from the usual, although it operates in the same fashion. An i.f. transformer with a center-tapped secondary is used, rather than the usual two-

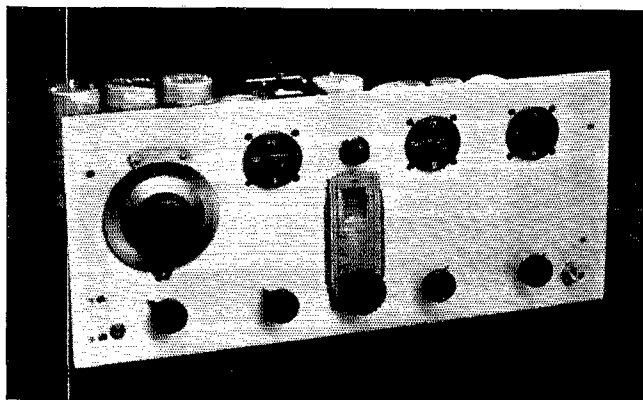

PANEL CONTROLS ARE PROVIDED FOR EVERY ADJUSTMENT NECESSARY FOR PEAK OPERATION—BUT THERE ARE NO NON-ESSENTIALS

The detailed plan of the panel layout is given in Fig. 2.

been thoroughly discussed in past issues of *QST* make its inclusion highly desirable, if not essential. Then a Type 57 first-detector, because of its

\* 4125 Main St., Downers Grove, Ill.

<sup>1</sup> J. J. Lamb, "Short-Wave Receiver Selectivity to Match Present Conditions," *QST*, August, 1932; and "An Intermediate-Frequency and Audio Unit for the Single-Signal Superhet," *QST*, September, 1932.

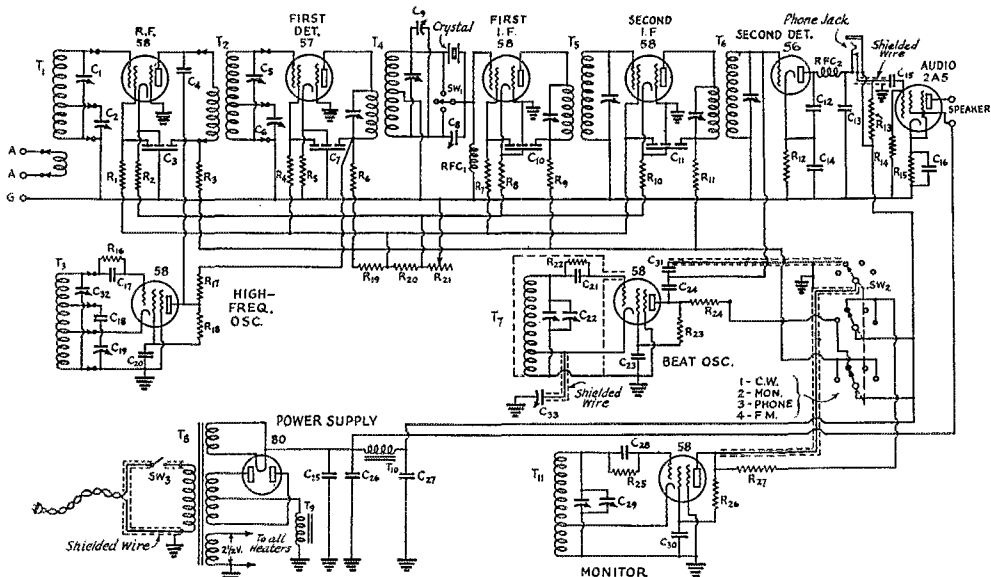

FIG. 1—THE CIRCUIT OF THE COMPLETE RECEIVER

- C<sub>1</sub>—Coil padding condenser—midget air condenser (See text).
- C<sub>2</sub> and C<sub>3</sub>—50- $\mu$ fd. tuning condenser (National 2-SE-50).
- C<sub>4</sub>, C<sub>5</sub>, C<sub>6</sub>, C<sub>7</sub>, C<sub>8</sub>, C<sub>9</sub>, C<sub>10</sub> and C<sub>11</sub>—Triple 0.1- $\mu$ fd. 200-volt paper condensers.
- C<sub>12</sub>—Oscillator coupling condenser (See text).
- C<sub>13</sub>—Midget air coil padding condenser (See text).
- C<sub>14</sub>—10- or 15- $\mu$ fd. midget air condenser (Phasing control).
- C<sub>15</sub>—30- or 40- $\mu$ fd. midget air condenser (Selectivity control).
- C<sub>16</sub> and C<sub>17</sub>—0.001- $\mu$ fd. mica.
- C<sub>18</sub>—0.5- $\mu$ fd. 200-volt paper.
- C<sub>19</sub> and C<sub>20</sub>—0.01- $\mu$ fd. mica.
- C<sub>21</sub>—10- $\mu$ fd. 25-volt electrolytic condenser.
- C<sub>22</sub>—100- $\mu$ fd. mica.
- C<sub>23</sub>—500- $\mu$ fd. mica (See text).
- C<sub>24</sub>—SE-50 National condenser—ganged to C<sub>2</sub> and C<sub>3</sub>.
- C<sub>25</sub> and C<sub>26</sub>—0.003- $\mu$ fd. mica.
- C<sub>27</sub>—100- $\mu$ fd. mica (supplied in b.o. assembly).
- C<sub>28</sub>—B.o. padding and vernier tuning condenser (in b.o. assembly).
- C<sub>29</sub>—1- $\mu$ fd. b.o. coupling condenser (See text).
- C<sub>30</sub>, C<sub>31</sub> and C<sub>32</sub>—8  $\mu$ fd. 500-volt dry electrolytic filter condenser.
- C<sub>33</sub>—100- $\mu$ fd. mica.
- C<sub>34</sub>—Two-section band-spread condenser, 100- and 20- $\mu$ fd. (Hammarlund MC-120 B).
- C<sub>35</sub>—Monitor coupling condenser (See text).
- C<sub>36</sub>—Midget air condenser, coil padding (See text).
- C<sub>37</sub>—30- or 40- $\mu$ fd. midget air condenser.
- R<sub>1</sub>, R<sub>7</sub> and R<sub>15</sub>—15,000-ohm 1-watt.

- R<sub>2</sub>—500-ohm 1-watt.
  - R<sub>3</sub>, R<sub>9</sub> and R<sub>11</sub>—2000-ohm 1-watt.
  - R<sub>4</sub> and R<sub>5</sub>—25,000-ohm 1-watt.
  - R<sub>6</sub>, R<sub>8</sub> and R<sub>10</sub>—1000-ohm 1-watt.
  - R<sub>12</sub>, R<sub>14</sub>, R<sub>16</sub>, R<sub>23</sub>, R<sub>24</sub> and R<sub>25</sub>—100,000-ohm 1-watt.
  - R<sub>13</sub>, R<sub>18</sub> and R<sub>27</sub>—50,000-ohm 1-watt.
  - R<sub>17</sub>—5000-ohm 2-watt.
  - R<sub>19</sub>—5000-ohm 1-watt.
  - R<sub>20</sub>—20,000-ohm 2-watt.
  - R<sub>21</sub>—5000-ohm tapered variable resistor (gain control).
  - R<sub>22</sub>—5000-ohm 1-watt.
  - R<sub>26</sub>—500-ohm 2-watt.
  - SW<sub>1</sub>—Yaxley single-gang 3-point switch.
  - SW<sub>2</sub>—Yaxley triple-gang 4-point switch.
  - SW<sub>3</sub>—Toggle switch.
  - T<sub>1</sub>, T<sub>2</sub> and T<sub>3</sub>—Front-of-panel plug-in coils (See text and table).
  - T<sub>4</sub>—Center-tapped 465-kc. i.f. transformer (Hammarlund air-tuned).
  - T<sub>5</sub> and T<sub>6</sub>—465-kc. i.f. transformers (Hammarlund air-tuned).
  - T<sub>7</sub>—465-kc. beat oscillator assembly (Hammarlund—includes R<sub>22</sub> and C<sub>21</sub>).
  - T<sub>8</sub>—Power supply transformer—Thordarson T-5003, 2.5 V. at 12 amps., 5 V. at 2 amps., and 267 V. at 80 ma.
  - T<sub>9</sub>—15-henry 75-ma filter choke.
  - T<sub>10</sub>—15-henry 50-ma filter choke.
  - T<sub>11</sub>—Monitor coil—16 turns No. 22 d.c.c. wire, length of winding  $\frac{1}{8}$  inch, cathode tap 5 turns from ground end.
  - RFC<sub>1</sub> and RFC<sub>2</sub>—Broadcast band chokes, 10- to 90-mh. (National R-200).
- The filter crystal is a 465-kc. Bliley.

section condenser, to secure the neutralizing voltage to modify the crystal's shunting capacity. This method works as well and does not require the rather large split condenser which takes up room and may have considerable capacity to ground and stray coupling—sources of trouble unless caution is used. The auxiliary secondary tuning condenser, C<sub>5</sub>, is set near zero capacity and resonance secured for straight super operation by adjusting the i.f. transformer condenser. On switching to the S.S. position (series crystal) the capacity of C<sub>5</sub> is increased until the desired degree of selectivity is secured. This condenser serves as

the selectivity or band-width control. For the optimum selectivity adjustment it is necessary to increase the capacity of C<sub>5</sub> by approximately 15  $\mu$ fd. It should be noted that the primary is tuned and loosely coupled to the secondary. Because of reaction between the tuned primary and secondary it is better to use less coupling (coils farther apart) here than in the other i.f. stages. A midget air condenser is used as the phasing control to eliminate the audio-beat image. This requires approximately 6  $\mu$ fd. with our particular crystal. This condenser, C<sub>8</sub>, is readily accessible. The grid bias for the first i.f. stage is fed through

the filter output coupling choke,  $RFC_1$ . This choke is only necessary for "series" crystal operation, although its connection direct to grid or to the open point on the crystal selector

over the usual external one. It is readily available for monitoring by a flip of the switch,  $SW_2$ . With  $SW_2$  thrown to the monitoring position, "B" voltage is supplied to the monitor and b.o. tubes,

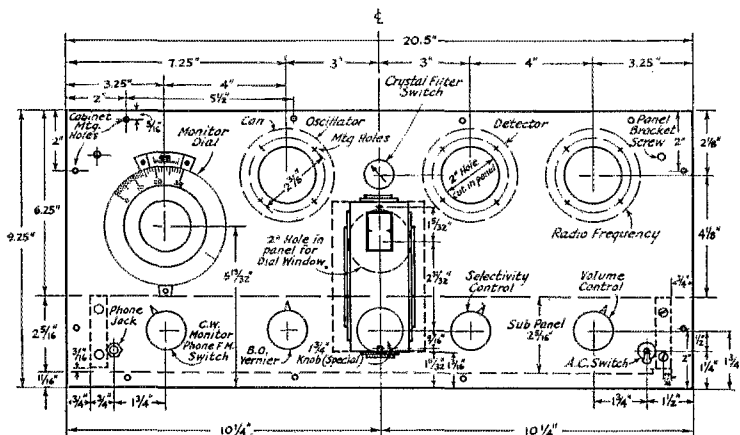

FIG. 2—DETAILED PLAN OF THE PANEL

switch is optional.

It is highly recommended that r.f. and i.f. circuits be air-condenser tuned, especially the r.f. beat-oscillator. With some 8 tuned r.f. and i.f. circuits, as well as 2 oscillator circuits, to be kept in line, it is good economy for those who want peak operation at all times to use tuned circuits that stay put. This is even more important for S.S. operation with the crystal; for it must be remembered that the i.f. circuits must remain tuned not only with each other but also to the crystal frequency.

A front-of-panel control is recommended for the audio beat-oscillator, since it is well known that different types of signals require different audio beats for an optimum adjustment. This is obtained by placing a midget air condenser between the cathode top of the b.o. and ground. The capacity of this condenser is large enough to vary the audio beat from zero to a few thousand cycles on one side of the i.f. frequency. The lead from the b.o. cathode tap to the condenser is shielded.

The built-in monitor has several advantages

the output of the monitor is connected to the grid of the second detector tube through the small coupling capacity  $C_{31}$ , and "B" voltage is disconnected from all tubes ahead of the second detector. The operation is as follows:

The monitor is oscillating 465 kc. higher or lower in frequency than the signal. The signal to be monitored is picked up in the monitor grid coil  $T_{11}$  and the monitor, by detector action, produces the beat between the two, or 465 kc. This i.f. frequency is in turn fed to the second-

detector grid through the coupling capacity  $C_{31}$ , and it is mixed here with the b.o. output. The second-detector then rectifies the two for the audio beat. Thus we have a *superhet monitor*. If there is not enough pick-up, a small antenna can be connected to the cathode tap of  $T_{11}$ ; and if there is too much the value of  $C_{31}$  can be decreased. A certain amount of control can be had by varying  $C_{31}$ , but its value should not be made too large.

The monitor is also used as a frequency meter.

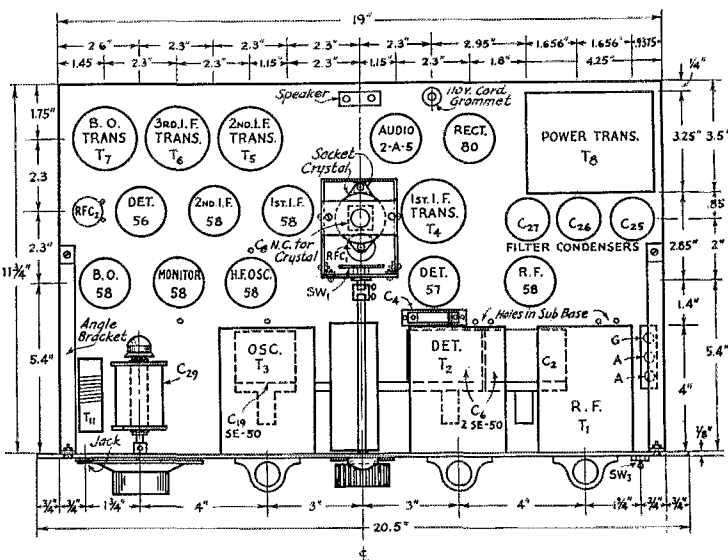

FIG. 3—DETAILED PLAN OF THE BASE

Throwing  $SW_2$  to the "F.M." position disconnects the audio b.o. and connects the monitor. With the frequency meter operating at the signal frequency, or a harmonic of it, an audio beat with the incoming signal is produced, the operation being the same as for the customary monitor operating with a non-oscillating receiver. In this case we have coupling through stray capacity.

In the rectifier circuit choke input is used to the filter. This was done to reduce the "B" voltage to about 240 volts, the voltage with condenser input to the filter being about 350 volts. The audio stage does not require so much filtering and its "B" tap is taken directly off the first section of the filter. This is also a method of decoupling the high-gain audio stage from the second detector. Fixed resistors  $R_{19}$  and  $R_{20}$ , together with the volume control  $R_{21}$ , determine the screen voltages for r.f., first-detector and i.f. stages, as well as bias for r.f. and i.f. stages for volume control. The voltage regulation to screen grids might be better with a larger value of bleeder current, but it is not necessary. Individual cathode resistors are used for all stages, limiting the minimum grid bias in the r.f. and i.f. stages. The 1000-ohm resistors for i.f. bias are somewhat larger than necessary, but prevent any chance of coupling between stages through the common cathode return and do not impair the sensitivity, since the set has more gain than ever can be used in practice.

The top view of the chassis shows the three coil cans mounted on the panel with the monitor condenser and coil to the left. The lower right tube is the r.f., to the left of it is the detector with the first i.f. transformer mounted just above it. In the center is the crystal filter mounted in its baffle shield can. The filter has the phasing condenser mounted on top of the can with the crystal mounted below it. The crystal switch is on the front and the coupling choke  $RFC_1$  is mounted on the base. To the left of the crystal filter are the first i.f., the second i.f. and detector tubes. The three transformers in the upper left corner, right to left, are the second i.f., third i.f. and audio beat-oscillator transformers. From the b.o. the shielded grid lead can be seen running to the b.o. tube directly below it in the bottom row. To the right of the b.o. tube are the monitor and high-frequency oscillator tubes. In the upper right hand corner is the power supply with the three electrolytic condensers, the power transformer and, to its left, the 80 rectifier and the 2A5 audio tube. In the top center are the speaker tip jacks and the 110-volt power cord.

In the bottom view the power transformer is in the upper left hand corner. To its right are the second filter choke, the 80 rectifier socket, and the 2A5 audio socket with grid resistor and coupling condenser. Between the sockets is the audio's cathode electrolytic condenser. Below the power transformer are the three filter condensers and the first filter choke. A baffle shield isolates the r.f., first detector and first i.f. transformer wiring from the rectifier and audio.

On this shield is mounted the selectivity condenser,  $C_9$ , by means of a special mounting bracket supplied by the condenser manufacturer.

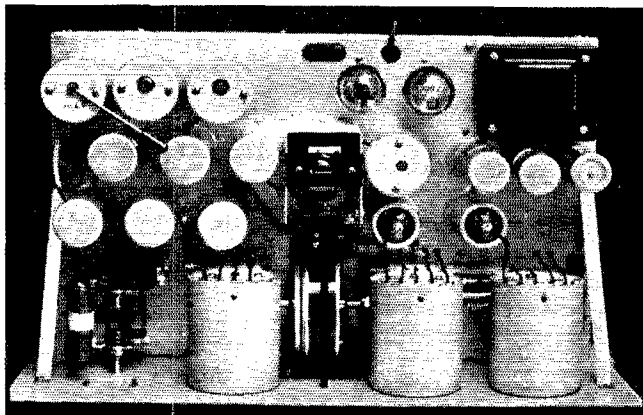

THE TOP VIEW OF THE RECEIVER ASSEMBLY

Fig. 3 gives the detailed plan.

$C_9$  is mounted directly below the first i.f. transformer and should be as much in the clear as possible to reduce its capacity to ground and to the wiring. A flexible insulating coupling and shaft extends to its control on the front panel. In the left bottom corner the antenna connections run from the binding posts through holes in the sub-base to the r.f. coil-can directly above. The two by-pass condensers for the r.f. and detector are mounted directly on the sub-base next to their respective sockets.

A mounting strip has been made up for the resistors. This is a piece of  $\frac{1}{16}$ -inch bakelite with connection terminals made by fastening soldering lugs in pairs with  $\frac{1}{4}$ -inch 6-32 screws. The resistor is soldered to one lug and the connecting wire to the other. This terminal strip is supported from the sub-base with  $1\frac{1}{2}$ -inch 6-32 screws. The two i.f. by-pass condensers in the upper right corner are fastened to a piece of  $\frac{1}{16}$ -inch bakelite and the bakelite, in turn, is fastened to the sub-base with  $1\frac{1}{2}$ -inch 6-32 screws. Below the condensers are the two i.f. sockets and below them, in the center, is the oscillator socket mounting. The baffle is of aluminum  $1\frac{1}{2}$  by 4 inches fastened to the sub-base with two small brackets made of  $\frac{1}{2}$ -inch brass angle stock. To the top of

this shield is fastened a resistor connection strip similar to the one previously described.

#### THE CHASSIS ASSEMBLY

This particular receiver was built to fit into a Comet "Pro" cabinet. Incidentally, the construction is such that it can be adapted for rack

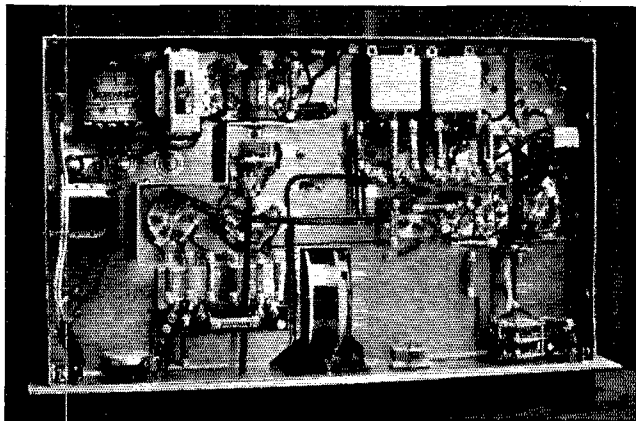

THE NEAT ARRANGEMENT OF COMPONENTS BENEATH THE BASE

*The wiring is described in the text.*

mounting. The front panel is a sheet of  $\frac{1}{8}$ -inch aluminum, which is sufficiently rigid. The sub-base is made of  $\frac{1}{16}$ -inch zinc alloy which can be bought under various trade names. It "works" somewhat better than aluminum and of course is cheaper. For those that like "battle-ship" construction it would be advisable to use  $\frac{3}{32}$ -inch sheet. However, the  $\frac{1}{16}$ -inch does very nicely and lessens the labor. Care should be used in making the bends. Sharp bends tend to split. In drilling, don't forget to use a lubricant. To cut the holes clean and not gum up the drills use soap mixed with water, or other suitable lubrication.

The sub-base should have a net depth of  $2\frac{5}{16}$  inches because the vertical clearance of the parts mounting on the front panel is very close. Corner posts should be made up of  $\frac{1}{2}$ -inch brass angle and fastened to the corners of the sub-base, thus strengthening it considerably. If the "Pro" cabinet is used it will be necessary to make each end of the sub-base  $2\frac{3}{8}$  instead of  $2\frac{5}{16}$  inches, and also to file off the front and back sides of the sub-base's corners for about  $\frac{3}{4}$  inch so it will clear the raised groove normally used to hold the "Pro" chassis. The sub-base is mounted to the panel by means of four flat-head screws. These pass through the corner posts of the sub-base. (See bottom view of chassis.) The panel and sub-base are made rigid by means of the two angle braces. These can also be made up of  $\frac{1}{2}$ -inch brass angle. All brass angle should be buffed, enhancing its appearance.

In laying out the sub-base and panel a sharp pointed pencil should be used. All dirt and pencil marks can be removed afterward by means of a metal polish or by sand blasting, but scratches are hard to remove. Where holes are to be drilled or where the scratches will be covered up by equipment, a scratch-awl or dividers can be used to advantage. The sub-base and panel should be completely laid out before drilling starts. Holes are hard to disguise, once there.

A template should be used in drilling the holes for the i.f. transformers. The socket holes should be  $1\frac{3}{8}$  inch, so as to clear the metal rivets of the isolantite tube sockets. A series of  $\frac{1}{2}$ -inch holes should be drilled around the edge of the sub-base for ventilation. To cut out the sub-base for the drum dial and for the transformer, a series of holes can be drilled to rough out the hole and then it can be finished down with a file. Don't forget to use a lubricant on the file and to clean it occasionally. All burrs should be removed by means of a small file, sharp knife or by using a larger drill so as to cut the burr

flush with the panel.

In laying out the front panel it should be remembered that the clearance on the parts is very close. The National "H S" drum dial is supplied with brackets which are used to mount the condensers. The type SE condensers just clear the sub-base and the h.f. coil cans. The center for the tuning knob of the dial is  $12\frac{3}{32}$  inches above the bottom of the front panel. The coil cans are mounted on a center-line  $2\frac{1}{8}$  inches below the top edge of the panel. The oscillator can is centered on this line, 3 inches to the left of the panel center-line and the detector 3 inches to the right. The r.f. can is centered 4 inches to the right of the detector can.

A baffle shield, made up of a piece of  $\frac{1}{8}$ -inch aluminum 5 inches by  $8\frac{1}{2}$  inches, is bent to fit between the first i.f. transformer and the first i.f. tube. This baffle is "open" on the top and the front side and is held to the sub-base with two brackets. A small strip of  $\frac{1}{16}$ -inch bakelite is mounted on top to hold  $C_8$  and another is mounted with brackets to the front to hold the crystal switch,  $SW_1$ . The crystal socket is mounted on the baffle, under the condenser  $C_8$ , by means of brackets. Holes are drilled in the sides of the baffle to bring the two leads in and the grid lead out.  $RFC_1$  is mounted directly on the sub-base beneath the switch. The baffle should be given a finish by buffing or sanding. This shield is probably unnecessary, but makes a good mounting for the filter.

The monitor condenser is mounted directly to the sub-base by means of a mounting bracket made of a strip of 1/2-inch brass. The monitor coil is mounted directly to the condenser.

COIL	BAND		
	3500 kc.	7000 kc.	14,000 kc.
$T_1$ Primary turns (Ant.) . . . . .	4 1/2	4 1/2	3 1/2
Secondary turns . . . . .	36 3/4	20 3/4	11 3/4
Sec. tuning tap, turns from ground end . . . . .	25.62	6 3/4	2 3/4
Approx. padding cap., $\mu\text{fd.}$ . . . . .	37	34	20
$T_2$ Primary turns . . . . .	27 1/2	15 1/2	8 1/2
Secondary turns . . . . .	36 3/4	20 3/4	11 3/4
Sec. tuning tap turns . . . . .	25.62	6 3/4	2 3/4
Approx. padding cap., $\mu\text{fd.}$ . . . . .	26	23	9
$T_3$ Total No. turns . . . . .	16 3/4	8 3/4	4 3/4
Tuning tap, turns from ground . . . . .	16 3/4	5 3/4	1 3/4
Cathode tap, turns from ground end . . . . .	5 1/2	3 1/2	1 1/2
Approx. cap., $\mu\text{fd.}$ . . . . .	100	90	85
No. of turns per inch for $T_1$ , $T_2$ , and $T_3$ . . . . .	24	14	10

All primaries wound with No. 34 d.s.c. All secondaries and the oscillator winding of  $T_2$  are No. 22 enameled wire.

Antenna coupling primary of  $T_1$  is wound in the end slot and spaced approximately 3/8 inch from the ground end of the secondary; primary of  $T_2$  wound between secondary turns, starting from the ground end (base).

Each form has a winding groove of specified turns per inch, cut with a right-hand thread on a lathe.

If 100- $\mu\text{fd.}$  tuning condensers are used instead of 50  $\mu\text{fd.}$ , the tuning condenser tap turns should be multiplied by 0.707 and  $C_{11}$  changed to 0.001  $\mu\text{fd.}$

The coupling condenser  $C_4$ , used to couple the h.f. oscillator to the first detector, has a capacity of about 1  $\mu\text{fd.}$  The exact value is not critical. On a 1/16-inch piece of bakelite, 5/8 inch by 2 5/8 inches, are mounted strips of 1/2-inch brass, spaced 1/4 inch with faces 1 1/2 inches high. This coupling condenser is mounted on the top of the sub-base between the first-detector and its condenser, so the connection to the plate lead running from pre-r.f. to first detector is short. The lead from the h.f.-oscillator to  $C_4$  is run above the sub-base to eliminate stray coupling.

The b.o. coupling condenser,  $C_{24}$ , has a capacity less than 1  $\mu\text{fd.}$  A 1/16-inch piece of bakelite 3/4-inch square spaces two 3/8-inch strips of brass 1 inch long. These strips are mounted at right angles so they overlap for 3/8 inch and are held by small screws to the bakelite. The protruding ends serve as terminals.  $C_{24}$  is mounted directly on the b.o. socket.

The condenser,  $C_{11}$ , used to couple the monitor to the detector, is two pieces of insulated hook-up wire twisted for one inch.

After all holes are drilled and the parts have had a trial fit, the sub-base should be cleaned. As much of the sub-base as possible should be wired before the front panel is mounted to the sub-base.

The filaments are wired with No. 14 and the rest of the set with No. 19 push-back wire, with the exception of the shielded leads. Don't forget that care in doing a good wiring job saves considerable trouble later.

#### THE PLUG-IN COILS

The band-spread coils are designed to give a tuning spread of approximately 100 degrees. The turns should be wound as accurately and uniformly as possible so the circuits will track. If possible the forms should have a winding groove cut on a lathe, as specified in Table I; if not, the turns should be spaced accurately and then doped in place. With 100- $\mu\text{fd.}$  tuning condensers, ready-wound National "FB" coils can be used. The mica condensers supplied with the National XR 39 (unwound) coil forms have a maximum capacity of approximately 40  $\mu\text{fd.}$  If 85- to 140- $\mu\text{fd.}$  air condensers are used to pad the pre-r.f. stage and the first-detector they should be modified by removing the required number of plates. However, for these stages air padding is not important and mica padding condensers can be used successfully. Air padding should be used for the oscillator coils, however, to avoid frequency creeping.

The following method was used in winding the coils. After the winding groove was turned on a lathe, small holes were drilled at the proper points to bring the leads through. The coil was wound and taps taken off as the winding progressed. The leads were then fished into their proper pins in the base. Next, leads were soldered to the padding condenser and these leads in turn fished into the contact pins. The leads were then cut off flush with the base of the pins and soldered. After soldering the flux should be cleaned from

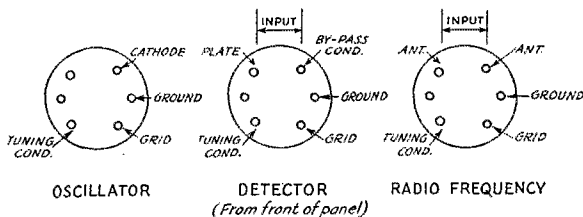

FIG. 4—CONNECTIONS TO THE PLUG-IN COILS

the pins. Flexible leads should be provided for the rotor plates of the air padding condensers. And don't forget to make the rotors go to the ground side. The wires can be more readily soldered to

(Continued on page 114)

# Completing the Three-Stage Transmitter

An 830 Amplifier—Frame Assembly—Final Adjustments and Tuning

By George Grammer, Assistant Technical Editor

**W**E HAVE yet to meet the amateur who has not had the desire—and the firm intention—some day to build his transmitter in one unit, so rigged that by connecting in a key, antenna leads, and hooking to the power line, the set would instantly be ready to go into action. And of course this “ideal” transmitter would be neatly built, would be reasonably compact, and would be imitative of commercial construction. The latter feature, in most amateurs’ minds, means a rack or frame mounting with all apparatus concealed behind a panel on which sundry controls and meters are very much in evidence.

There is much that is commendable in this attitude. Certainly a much better impression can be made if visitors view a finished-looking job instead of a collection of apparatus sprawled all over the table and floor, no matter how efficient the haywire rig might be. And the personal satisfaction is immensely greater if the set not only works well but looks well. On the other hand, breadboard construction has many points in its favor. The thing to do, then, is to combine the good points of the breadboard layout with the

good appearance of the frame-and-panel mounting. This we have endeavored to accomplish in the present series of articles.

As intimated in the descriptions of the tri-tet oscillator and the 841 amplifier stage,<sup>1</sup> the design of these units has been part of a consistent plan by which, with ordinary simple breadboard construction in each individual stage, the whole series can be assembled in a frame to make a complete transmitter of moderate power output, having when finished the sort of appearance which is currently popular. In fact, the moral of the whole thing might be that if one starts out with a plan in mind, the first piece of apparatus built will be equally as useful as the last—it need not be discarded simply because enlargement upon the original design is contemplated.

In the present case the last piece of apparatus is the final amplifier, a unit similar in circuit to the 841 amplifier described last month, but using an 830 tube.

## THE FINAL AMPLIFIER

The photographs show two views of the 830 amplifier, while its circuit diagram is given in

Fig. 1. The baseboard is the same size as those used with the preceding units, 11 by 14 inches, and the arrangement of apparatus is much the same as that used with the 841 amplifier. The single exception is the coil mounting, which is placed so that the axis of the tank coil is at right angles to the axis of the 841 tank coil mounting, the object of this being to minimize coupling between the two. The split-stator tank tuning condenser is centrally located on the baseboard; to its left are the plate blocking condenser, the plate r.f. choke, the tube socket, and the neutralizing condenser. Toward the rear are the grid r.f. choke and the two input coupling condensers. The coupling condenser in the input lead to the filament center tap is an insulating condenser made necessary by the biasing arrangement employed in the complete transmitter, as will be explained later on.

Filament and plate power and

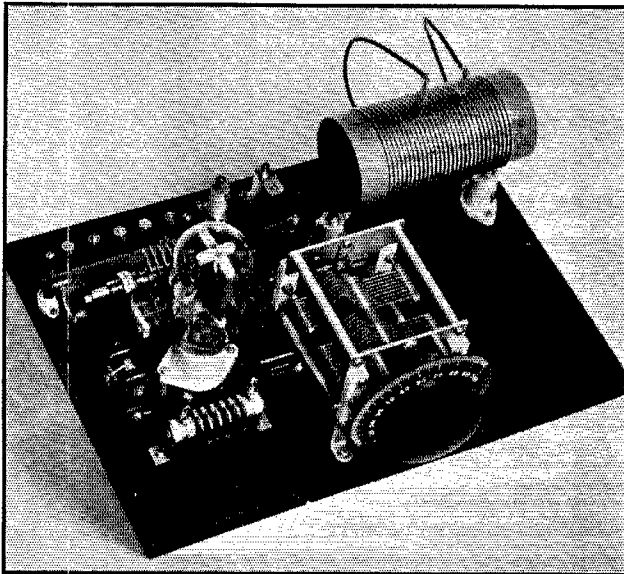

**THE FINAL AMPLIFIER UNIT USES AN 830 TUBE**  
*The output is approximately 50 watts on any one of four bands.*



bias leads are brought in through a terminal strip at the rear left edge of the board. Connections from these terminals run under the baseboards to appropriate parts of the circuit. By-pass condensers for the 830 filament are mounted vertically on a piece of brass strip located close to the filament terminals on the tube socket. The r.f. input and output terminals are Isolantite stand-off insulators at the rear center and rear right, respectively. As in the other units, all circuit components carrying r.f. potentials are mounted on small porcelain stand-offs. The placement of parts is such that the wiring is as short and direct as possible.

The amplifier tank condenser,  $C_6$ , is a split-stator condenser having a total capacity of 175  $\mu\text{fd}$ . (two 350- $\mu\text{fd}$ . sections in series). With up to 1000 volts on the plate, ordinary receiving-condenser spacing between plates will be sufficient since the series connection of the two sections doubles the voltage break-down rating. The two sections of the condenser are used to provide the r.f. voltage division necessary for neutralization, as explained previously. This type of neutralizing circuit is particularly beneficial in this case because its use results in a reduction of input capacity, a desirable feature since the 830 is capacity-coupled to the 841 driver. It should be pointed out that link coupling between stages could be used to good advantage, but in the design of this transmitter it was thought advisable to use capacity coupling so that the number of plug-in coils and tuning controls would not reach unwieldy proportions. The effective input capacity of the 830 with its associated neutralizing circuit is sufficiently low to permit satisfactory operation at 14 megacycles, the frequency at which high input capacity is most likely to cause trouble.

The final amplifier tank coils are a factory-made product recently marketed. They are wound on grooved forms provided with a slot into which special clips can be inserted, thus making it possible to tap any turn without the necessity for soldered tabs. The coils are fitted out with plugs which are inserted in jack-top stand-off insulators. The turns specifications are given under Fig. 1. The inductances are such that resonance will be reached in each band with a tuning capacity of about 70  $\mu\text{fd}$ .

The one feature which might be called unusual

<sup>1</sup>"A One-Tube Crystal-Control Transmitter," *QST*, March, 1934; and "Adding to the Single-Tube Transmitter," *QST*, April, 1934.

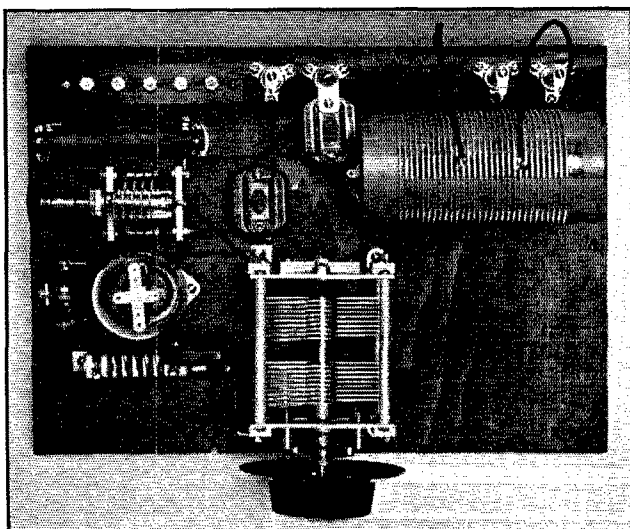

A PLAN VIEW OF THE 830 AMPLIFIER

The location of the various circuit components is described in the text.

in the amplifier circuit is the use of a home-made r.f. choke in the grid circuit at  $RFC_1$ . In the first trial of the amplifier, during which a manufactured choke was used in this position, a low-frequency parasitic oscillation developed when the tank condenser was set in the lower-capacity

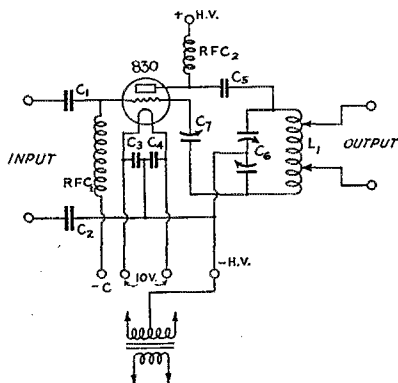
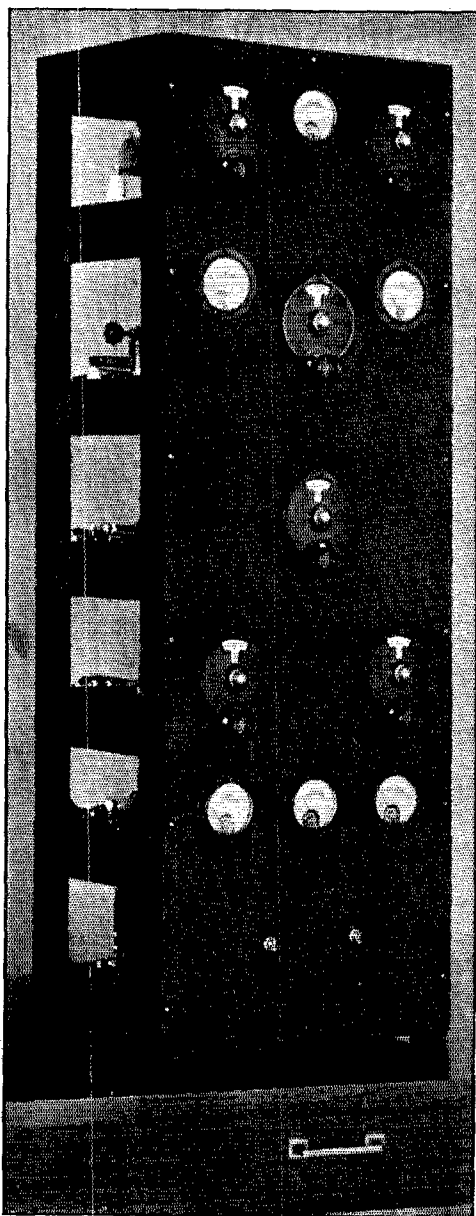

FIG. 1—THE 830 AMPLIFIER CIRCUIT DIAGRAM

- $C_1$ —70- $\mu\text{fd}$ . mica condenser.
  - $C_2$ —500- $\mu\text{fd}$ . mica condenser.
  - $C_3, C_4$ —005- $\mu\text{fd}$ . mica condensers.
  - $C_5$ —500- $\mu\text{fd}$ . mica condenser, 2500-volt rating.
  - $C_6$ —Split-stator variable condenser, 350- $\mu\text{fd}$ . each section (National).
  - $RFC_1$ —3-inch winding of No. 34 s.s.c. on half-inch bakelite form.
  - $RFC_2$ —Transmitting choke (Hammarlund).
  - $L_1$ —1.75 mc.: 45 turns No. 14 wire on 3-inch diameter form, winding length 4½ inches.
  - 3.5 mc.: 30 turns No. 14 wire on 2½-inch diameter form, winding length 3¾ inches.
  - 7 mc.: 15 turns No. 14 wire on 2½-inch diameter form, winding length 3¾ inches.
  - 14 mc.: 10 turns No. 14 wire on 2-inch diameter form, winding length 4 inches.
- (Coils made by Gross Radio Company.)



WITH BREADBOARD UNITS MOUNTED IN A FRAME AND CONCEALED BEHIND A PANEL, THE FINISHED TRANSMITTER TAKES ON A MORE PLEASING APPEARANCE

The six dials operate the variable condensers in the r.f. circuits. The lower two are for the oscillator condensers, the next above for the buffer-doubler, followed in ascending order by the final amplifier and antenna-coupler controls. The lower row of instruments includes a high-voltage d.c. voltmeter and milliammeters for the oscillator and buffer-doubler stages. The filament voltmeter and plate milliammeter for the final amplifier are on either side of its tuning control, while the r.f. ammeter is between the antenna-coupler dials.

region of its scale. Inspection showed that under these conditions the capacities shunting the two chokes caused them to become approximately resonant and resulted in a tuned-plate tuned-grid type of oscillation. Replacing the manufactured choke with a single-layer choke of considerably less inductance completely eliminated the parasite. The grid choke  $RFC_1$ , should be designed to be most efficient at 14 mc., the frequency at which the excitation is lowest in the normal course of events. On the lower-frequency bands the excitation will be considerably greater than actually is necessary, hence some loss of efficiency in the choke can be tolerated at those frequencies.

#### INTERSTAGE COUPLING

The upper input terminal in Fig. 1 (from  $C_1$ ) should be connected to the plate end of the 841 tank coil, while the input terminal connected to  $C_2$  should go to the filament center-tap of the 841 stage. Joining the two stages together in this way avoids the necessity for tapping the 841 tank coil, but makes the value of the grid coupling condenser,  $C_1$ , somewhat critical. The capacity of  $C_1$  should not exceed 75  $\mu\text{fd.}$ , otherwise the driver stage is likely to be overloaded on 14 mc. and the 830 will not get full excitation.

A somewhat unfortunate result of this method of coupling is that the capacity balance between the two sections of the 841 tank circuit is upset, since both the input capacity of the 830 and the plate-filament capacity of the 841 are shunted across one section of the 841 tank condenser. This causes the capacity ratio between the two sections to change as the 841 tank condenser is varied and thereby upsets the neutralizing of that stage; in other words, if the 841 is neutralized with a given setting of its tank condenser, a considerable change in the tank condenser tuning will cause the stage to go out of neutralization. To maintain fixed neutralization in this stage, therefore, it is necessary to proportion the tank coils so that all will be resonant at approximately the same condenser setting, a job which requires a few minutes cut-and-try, but which pays dividends in making band-changing convenient.

#### OPERATING THE AMPLIFIER

The 830 amplifier is neutralized and tuned in just the same way as the 841 stage, so the reader is referred to the April article for a description of those processes.

In determining the proper coupling between the amplifier and the antenna coupler, and between the latter and the antenna system or feeders, some experimenting will be found to be necessary. If a two-wire feed system or current-fed Hertz antenna without feeders is used, the clips on the amplifier tank coil,  $L_1$ , should be placed equidistant from the center of the coil and should include one-quarter to one-third the

total number of turns. The input condenser in the antenna coupler should be set near minimum capacity and the output condenser at about half scale. The settings of the clips on the filter coils will depend upon the band to be used. For 14 megacycles, approximately 5 turns in each coil will be used; for 7 megacycles, approximately 10 turns in each; for 3.5 megacycles, 15 or 20 turns; and for 1.75 megacycles, the whole of both coils.

Before attaching the clips to  $L_1$ , the amplifier stage should be tuned to resonance, as indicated by minimum plate current. After this adjustment is completed the tank condenser,  $C_6$ , is left set; all further tuning is done with the antenna-coupler controls. Close the key and rotate the antenna-coupler input condenser to the point which causes the amplifier plate current to dip. If the minimum plate current obtained in this way is greater than normal plate current of the tube, leave the input condenser at the minimum-plate-current setting and rotate the output condenser to ascertain if the plate current can be brought down to normal. If it is still too high, it may be possible to bring it down by increasing the inductance in the filter coils; or, as a final resort, by decreasing the number of turns between the taps on  $L_1$ , and repeating the coupler-tuning process. With correct positioning of all taps and condenser settings, it should be possible to vary the plate current to the 830 from 50% of rated current to 50% more than rated current simply by rotating the antenna-coupler *output* condenser. When the output condenser has been set to make the tube draw normal plate current, the input condenser should be retuned to make certain that it is set for minimum amplifier-tube plate current. As a final check, the amplifier tank condenser,  $C_6$ , should be retuned, also for minimum plate current. If the setting is found to differ from that determined with the antenna coupler disconnected, the coupler is not properly adjusted. The resonance setting of  $C_6$  should be exactly the same either with or without the antenna coupler connected.

After a satisfactory adjustment has been reached, it will be worth while to repeat the process with a new setting of the taps on  $L_1$  or with different values of inductance in the antenna-coupler filter coils. The object of the adjustments is to obtain the greatest antenna or feeder current with a given plate power input; and it is sometimes surprising to find how much can be accomplished by trying different combinations of taps and condenser settings. Once the "best" combination has been found, the data on taps and dial readings should be jotted down so the optimum adjustments can be duplicated readily when returning to that band.

In the preliminary trials, it is wise to keep the key closed only long enough to see what the effect of the last adjustment has been, since it is only



**POWER SUPPLY LEADS TO THE THREE STAGES ARE CABLED FOR EASY IDENTIFICATION AND TO PREVENT UNSIGHTLINESS IN WIRING**

*This rear view of the frame shows the six shelves resting on the horizontal supporting strips. The two lower shelves contain the power-supply equipment, followed in regular order by the oscillator, buffer-doubler, final amplifier and antenna coupler. The plate and filament transformers and the rectifier tubes are mounted on the lowest shelf. Filter condensers, chokes, the high-voltage bleeder, and the voltage-divider for the low-power tubes are located on the second from the bottom. The r.f. units are readily removable once the power and r.f.-coupling leads have been detached and the condenser shafts loosened from the dials.*

too easy to injure the tube filament when the tube is drawing excessive plate current, especially if the tank circuit is off resonance.

If a Marconi antenna system or a single-wire feeder is used, the filter coil which connects to the ground terminal should be shorted out and

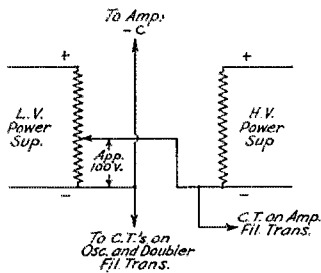

FIG. 2—HOW BIAS FOR THE FINAL AMPLIFIER IS OBTAINED FROM THE LOW-VOLTAGE POWER SUPPLY

Part of the voltage drop across the low-voltage bleeder is utilized as bias for the 830. The negative terminals of the two plate supplies cannot be tied together when this method of obtaining bias is used.

the tap which connects to that filter coil should be placed on the center turn of  $L_1$ . The other tap should be placed about half-way between the center and the plate end of  $L_1$ . This position is subject to later modification, further adjustments being as described for the two-wire system. The only difference is that the center-tap is left fixed, only the other being moved.

COMPLETE TRANSMITTER ASSEMBLY

In laying out the baseboards for the individual r.f. units, care has been taken so that all tuning controls would be symmetrical when brought out to the panel in the completed frame mounting. The several units are shown mounted in a home-made wooden frame in two of the photographs. This frame is constructed of ordinary 1 x 2 dressed white pine, readily obtainable at any lumber yard. Dimensions will vary according to the power supply apparatus used; in this case the total height is 46 inches, which makes the transmitter suitable for placing either on the floor or on the operating table. Four main uprights support the whole assembly, being fastened together with horizontal pieces of the same stock. These horizontal members also serve as supports for the baseboards. The baseboards, which are slid in the frame from the rear, rest with their front edges against the back of the panel. The rear vertical members project about an inch beyond the rear edges of the baseboards so that all the wiring between the units will be within the confines of the frame. In determining upon the heights required in each compartment, allowance should be made for taking tubes out of the sockets; it is easy to forget that couple of

extra inches needed in each compartment should a tube have to be removed and replaced.

The panel is a piece of 3-ply wood. Some of the other construction materials (Masonite, Presd-wood, etc.) would do equally well, but in many cases are softer than the wood and therefore less satisfactorily worked, as well as being more expensive. Exclusive of hardware, this frame and panel together cost less than a dollar.

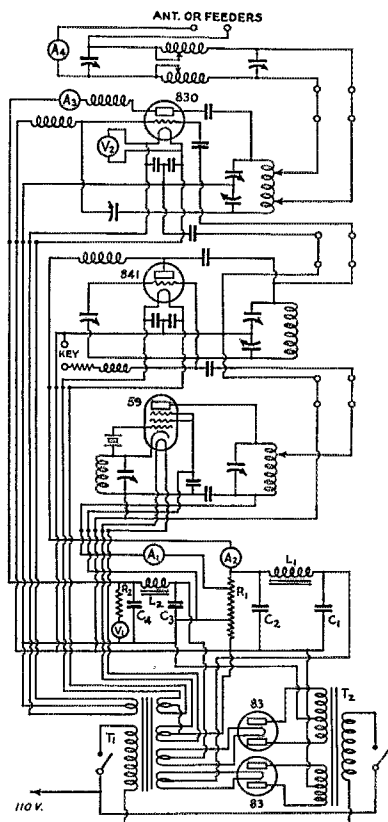

FIG. 3—THE COMPLETE TRANSMITTER CIRCUIT DIAGRAM

The connections of the r.f. units will be readily identified by comparison with the diagrams previously given (March and April, QST's). Other components are as follows:

- T<sub>1</sub>—Filament transformer; two 5-volt windings; one 2.5-volt winding; one 7.5-volt winding; and one 10-volt winding.
- T<sub>2</sub>—Plate transformer; 650-volt winding and 350-volt winding.
- C<sub>1</sub>, C<sub>2</sub>—Double-section dry electrolytic condenser, 8μfd. each section.
- C<sub>3</sub>, C<sub>4</sub>—4μfd. 1000-volt rating.
- L<sub>1</sub>, L<sub>2</sub>—30-henry 150-ma. choke (commercial rating).
- A<sub>1</sub>—0-100 d.c. milliammeter.
- A<sub>2</sub>—0-200 d.c. milliammeter.
- A<sub>3</sub>—0-300 d.c. milliammeter.
- A<sub>4</sub>—0-2.5 r.f. ammeter.
- V<sub>1</sub>—0-10 d.c. voltmeter with multiplier to raise maximum scale reading to 1000 volts. The multiplier also functions as the bleeder across the high-voltage plate supply.
- V<sub>2</sub>—0-10 a.c. voltmeter.

A complete wiring diagram of the transmitter is given in Fig. 3. The two power supplies are entirely conventional in circuit arrangement, using 83 rectifiers with condenser-input filters. One transformer lights the filaments of all tubes, including the rectifiers; this particular transformer was home-built for the job. The plate transformer is a 650-volt broadcast-receiver type transformer which has had all the filament windings removed to make room for an additional 350-volt winding. Under load conditions the output of the high-voltage winding, with the condenser-input filter, is 750 volts at 110 milliamperes, exactly the rated input for the 830 amplifier. There is little need for a more detailed description of the power-supply apparatus actually used, since amateurs invariably make use of whatever equipment is on hand.

In making up a power supply it will be necessary, of course, to provide transformers to light all the filaments. The filament transformer or transformers preferably should be separate from the plate-power transformers so that the filaments can reach operating temperature before plate voltage is applied. Two separate plate power supplies, one for the oscillator and buffer and a second for the final amplifier, are advisable. Suitable transformers and filtering equipment are readily available from several manufacturers. The low-voltage supply should have an output of 400 to 500 volts at 125 milliamperes, and the high-voltage supply 750 to 1000 volts at 150 milliamperes. Choke-input filters are recommended from the standpoint of good voltage regulation, although if the secondary voltage of the plate transformer is low the condenser-input filter has the advantage of giving higher output voltage. Design data for suitable power supplies is to be found in *The Radio Amateur's Handbook*.

In the final circuit of the transmitter, part of the voltage available across the voltage divider of the low-voltage plate supply is used to bias the final amplifier stage. This is done by connecting the negative terminal of the high-voltage supply to a point about 100 volts from the negative end of the low-voltage bleeder, and running a connection from the negative end of the bleeder to the "-C" terminal on the amplifier. The tap should be adjusted so that the amplifier plate current is reduced approximately to zero without excitation. Additional bias under operating conditions is secured through the flow of grid current in the portion of the bleeder between the negative terminal and the tap. The actual resistance used in this case is approximately 6000 ohms, the total bleeder resistance being 20,000 ohms. Fig. 2 shows the details of the arrangement more clearly. Obviously there can be no common negative connection between the two power supplies with this method of obtaining bias.

In practically every case insulated couplings with extension shafts are used to couple the tuning condensers to the National Type B dials on the panel, since the condenser shafts alone are not long enough to reach clear through to the dials. Besides being a necessity, this method of coupling has an advantage as well—it is easy to disconnect the dial from the condenser shaft if a unit is to be removed from the frame for repairs or alterations. The alternative, mounting the condensers directly on the panel, would lead to constructional difficulties and make the various units less readily removable.

Aside from tuning controls, the panel layout will depend upon the number of meters available. In this case, a separate milliammeter is used for each stage. A single plate current meter with plugs and jacks could be used equally well; the only sacrifice would be a small amount of convenience. A filament voltmeter for the 830 is desirable, since a thoriated filament should be operated at constant voltage if longest life is to be secured. The plate voltmeter shown in the diagram is a 0-10 d.c. instrument taking about 16 milliamperes at full scale; the bleeder across the high-voltage supply (approximately 62,000 ohms, made up of three standard 10-watt wire-wound resistors) acts as a multiplier to raise the full-scale reading to 1000 volts.

The leads from the power supplies to each r.f. unit are separately bunched and laced together in three cables. The ends which connect to the terminal strips are cut to such a length that each wire just reaches the proper terminal; once the cable is completed and laced up it is practically impossible to put a connection on the wrong terminal. The r.f. connections between units are made with No. 14 enamelled wire.

One toggle switch at the bottom of the panel controls the filament power; the other cuts the primary of the plate transformer.

#### A FEW KINKS

To facilitate coil changing once the various units are mounted in the frame, it is advisable to equip all coils with plugs and use jack-type standoffs in place of the small porcelain insulators shown in the photographs of the oscillator and buffer in the previous articles. The coils themselves can be mounted, with the plugs, on small bakelite strips of appropriate length. Although not strictly necessary, this refinement will save time in changing bands and will help to protect the coils from injury.

Once the transmitter has been completed and mounted in its frame, the process of tuning and neutralizing should be gone through for each band, dial settings and plate currents being recorded so that the proper adjustments for each

(Continued on page 118)

# H A M D O M



*We present, fittingly, five "first" citizens of Hamdom:*

**CLARENCE D. TUSKA** was the first secretary of the League, and co-founder and first editor of *QST*. He brought to these positions eight years of radio experience, beginning with a coherer in 1907, following with an E. I. Co. electrolytic detector. In 1908 he moved to Hartford, Connecticut, from New York City, where he was born August 15, 1896. It was there he achieved his first full-fledged amateur station, with a commercial operator's license in 1913 and eventually the coveted special station license. Commissioned in the U. S. Army in 1917, he was associated with the Air Service during the war, training radio operators. After the war, he acted as consultant for the A. C. Gilbert Company of New Haven, and established the C. D. Tuska Company of Hartford, where he made the famous old Tuska "Superdyne" and other sets. He was operating a broadcasting station prior to the national election of 1920. In view of all this commercial broadcast activity he resigned from active participation in A.R.R.L. affairs. In 1926 he became associated with the Atwater Kent Mfg. Co., where he has remained to this date, specializing in radio patent matters.

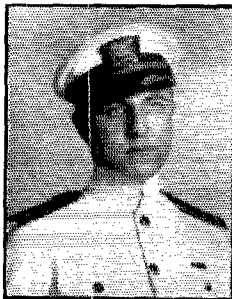

MATTY, 9ZN

**R. H. G. MATHEWS** was a prime mover in the original middle western relay organization of the League, one of the first Trunk Line Managers, and perhaps the outstanding amateur of the country for a period of many years. Born January 16, 1897, in



QST—IWD—A.R.R.L.



6EB

6EA

Springfield, Ohio, he built his first amateur station there in 1909. In 1911 he moved to Chicago, joined the old Chicago Wireless Association, and operated with the call RM. The Radio Act of 1912 caused him to become licensed as 9IK, which later became special license station 9ZN. In 1914, he began a four-year engineering course at Armour Institute of Technology, during most of this time serving as Central Division Manager of the A.R.R.L., and for a short time as vice-president of the League. It was then 9ZN achieved its fame, with three gigantic transmitters housed in a portable building on the shore of Lake Michigan near

the Edgewater Beach Hotel — transmitters which usually developed antenna currents on the order of 25 amperes! Mathews' post-war activities have been with the Chicago Radio Laboratory, Zenith Radio Corporation, American Broadcasting Corporation, as chief engineer of a number of firms, later as head of R. H. G. Mathews and Associates, and, currently, the Radio Manufac-

turers' Sales Company.

**HOWARD AND LYNDON SEEFRED** were born in Los Angeles when Marconi sent his first wireless message. The conjunction must have been auspicious, for before 1912 they had heard JJC, a Japanese spark, on a crystal detector. When the A.R.R.L. was organized they became Pacific Coast Division Managers, and began establishing an incredible number of "firsts." 6EA was the first West Coast station heard in Hawaii, in Alaska, and on the

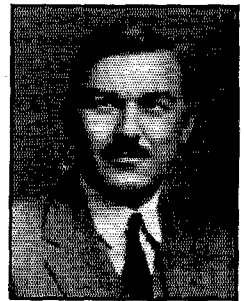

CANUCK, 9AL

(Continued on page 70)

# Regeneration in the Tuned R.F. Stage

## A Simple Method of Increasing the Selectivity and the Sensitivity of the Tuned R.F. Receiver

By Walter Sullivan, W6CGR\* and Fred Kienle, W6FMG\*\*

**T**HE wave of superhet building and buying in ham ranks has caused the t.r.f.-regenerative receiver to go into eclipse during recent months, although not all of us are fortunate enough to possess this popular type of receiver. Many of us still have to do the best we can with the older t.r.f. set, despite the unfavorable comparison between it and the superhet in selectivity. But even after several years of continuous improvement, much still remains to be done with the t.r.f. set; its possibilities have not been wholly explored by any means. The proof of this can easily be attested by anyone who will take the trouble to make a few simple changes in his present t.r.f.-regenerative receiver; at negligible cost the selectivity and sensitivity of the set can be increased to a surprising degree.

The "how" and "why" are not difficult to explain. Although the idea presented here is not a new one, apparently it has not been applied to ham receivers in recent years. All of us are aware of the fact that regeneration increases not only amplification but also selectivity; very well, then, why not apply it to the tuned r.f. amplifier and thereby take advantage of the amplifier tube's full possibilities? Years ago such a scheme was proposed by Landon<sup>1</sup> for use with triodes in broadcast-band receivers; it should prove even more effective to-day, with our superior tubes and greater knowledge of circuit design and layout. It not only should, it does! Naturally there are a few tricky angles to

the thing, and the treatment of these constitutes the basis of this article.

### REGENERATION IN THE R.F. STAGE

If regeneration is introduced into an ordinary r.f. stage having transformer or impedance coupling to the detector, the tuning of one stage is almost certain to "pull" the tuning of the other very badly, causing one or the other to break into unwanted oscillation. The effect is

much the same as that experienced in an ordinary receiver which suffers from insufficient shielding between the two stages. There would be little pleasure in operating such a receiver. To secure the full benefit of regeneration in the r.f. stage, therefore, the tuning and regeneration controls of both the r.f. stage and detector must be wholly independent—interlocking simply cannot be allowed to exist. Preliminary experiments with an a.c. Super-Wasp immediately made it evident that elimination of interlocking was Problem No. 1.

The solution of the interlocking question was found to be the insertion of an untuned "buffer" tube between the r.f. stage and detector. Although the buffer tube adds no controls to the receiver and requires, but a few additional parts, it isolates the two stages effectively and incidentally provides a little additional amplification. There are

several methods by which a buffer may be connected in the receiver, but the simplest and most satisfactory has been found to be through the use of impedance coupling between the plate of the tuned stage and the grid of the buffer, with conventional transformer coupling between the buffer plate and the tuned grid circuit of the



**REGENERATIVE R.F. AMPLIFICATION GIVES THIS BATTERY-OPERATED PORTABLE RECEIVER A HIGH DEGREE OF SENSITIVITY AND SELECTIVITY**

*The buffer tube in its shield occupies the space between the r.f. and detector stage compartments, at the left and right respectively.*

\* 6516 Lexington Ave., Hollywood, Calif.

\*\* 4341 Melbourne Ave., Hollywood, Calif.

<sup>1</sup> Landon, "Multiple Regeneration," *Radio Broadcast*, March, 1926.

detector. The essentials of the circuit used with the a.c. Super-Wasp are given in Fig. 1. It will be noted that the plate of the tuned r.f. tube, a 58, is fed through a radio-frequency choke and is coupled back to the tickler coil through a 250-

number of turns in the grid coil); the detector plate circuit is arranged with parallel plate feed and a grounded tickler so that all three windings can be accommodated on a five-prong coil form.

Since Fig. 1 is shown chiefly to indicate the way in which one successful circuit has been arranged, no rigid specifications are given for those circuit parts which have the same work to perform in this as in any tuned r.f. circuits. The tuned circuits will have the same constants as in other receivers, and band-spread may be obtained by any of the well-known methods. The tickler coil on the r.f. stage probably will have about the same number of turns as the tickler in the detector stage; a few trials with coils of different sizes readily will show which number of turns gives the smoothest action. The essential

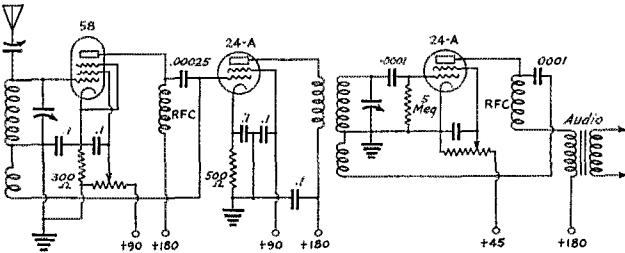

FIG. 1—REGENERATION IN R.F. STAGE AS APPLIED TO AN A.C. RECEIVER

The 24-A buffer tube is used to isolate the tuned r.f. stage from the detector and thus make their tuning independent. Circuit values not shown are the same as would be used in ordinary tuned-r.f. receivers. The biasing resistor in the cathode circuit of the 24-A should be approximately 500 ohms

μfd. fixed condenser. The grid of the buffer tube is connected directly to the "hot" side of the tickler. The r.f. voltage developed across the tickler coil is thereby applied between grid and cathode of the buffer tube.

In this particular set the buffer tube was placed on the chassis between the two compartment shields which enclosed the tuned r.f. and detector stages of the Wasp. The buffer tube should be shielded; in fact, thorough shielding between all stages is essential to prevent interlocking. The plate of the buffer tube is connected to a third winding on the detector coil form (this primary winding should have about  $\frac{2}{3}$  the num-

ber of turns in the grid coil); the detector plate circuit is arranged with parallel plate feed and a grounded tickler so that all three windings can be accommodated on a five-prong coil form.

#### COIL DATA

Band	L <sub>1</sub>	L <sub>2</sub>	L <sub>3</sub>	L <sub>4</sub>	L <sub>5</sub>	L <sub>6</sub>
3.5 mc.	3	4	3	4	4	2
7 mc.	6	10	7	10	10	4
14 mc.	15	25	17	15	15	10

All wound with No. 26 d.c.c. wire on 1 1/4-inch diameter forms.

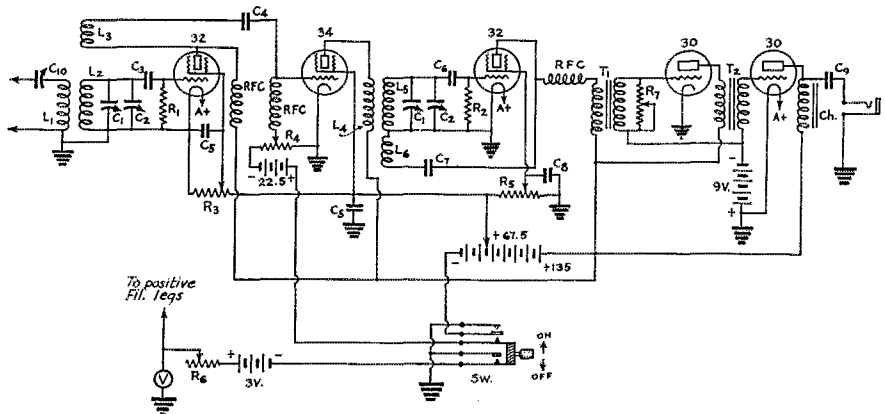

FIG. 2—CIRCUIT DIAGRAM OF THE PORTABLE D.C. RECEIVER

- C<sub>1</sub>—35-μfd. midget condenser.
- C<sub>2</sub>—250-μfd. midget condenser.
- C<sub>3</sub>—100 μfd.
- C<sub>4</sub>—100 μfd.
- C<sub>5</sub>—100 μfd.
- C<sub>6</sub>—100 μfd.
- C<sub>7</sub>—1 μfd.
- C<sub>8</sub>—1 μfd.
- C<sub>9</sub>—25 μfd.
- C<sub>10</sub>—250-μfd. variable.

- R<sub>1</sub>, R<sub>2</sub>—2 megohms.
- R<sub>3</sub>, R<sub>4</sub>, R<sub>5</sub>—50,000-ohm potentiometers.
- R<sub>6</sub>—6-ohm rheostat.
- R<sub>7</sub>—500,000-ohm variable resistor.
- R<sub>8</sub>—0-3 d.c. voltmeter.
- T<sub>1</sub>, T<sub>2</sub>—Audio transformers.
- RFC—Short-wave chokes, universal-wound type.
- SW—Yaxley Multiple Switch.



the tube when used as an r.f. amplifier. The r.f. tube should be biased just as it is in ordinary r.f. circuits.

#### TUNING KINKS

Tuning the receiver equipped with a regenerative r.f. stage is very similar to the tuning of an ordinary receiver, except that more care will be needed in adjusting the r.f. tuning. With adequate shielding between all tubes and stages the detector tuning will be completely independent of the r.f. tuning so long as the r.f. tube is not allowed to oscillate. A good way to become familiar with the handling of the receiver is first to set the r.f. regeneration-control potentiometer well below the point at which the r.f. tube oscillates and tune in a signal with the detector in the usual way; then, leaving the detector alone, increase the screen voltage on the r.f. tube, simultaneously retuning the r.f. grid circuit if necessary, until the r.f. tube is just below the oscillating point. As the regeneration is increased by increasing the screen voltage, the signal strength and selectivity will likewise increase, until at the optimum regeneration setting both sensitivity and selectivity will be markedly greater than with a normal non-regenerative r.f. stage. The r.f. stage should never be allowed to oscillate, however.

The r.f. and detector tuning condensers may be ganged, but it will be necessary to use care in adjusting the inductance of tuning coils so that the two circuits will track accurately enough. The increased selectivity of the r.f. stage makes its tuning more critical than is the case with the fairly broad non-regenerative r.f. stage, and it is for this reason advisable to have a small trimmer across the r.f. tuning condenser to help in lining up and to serve as a vernier adjustment when a particular signal is to be pulled out of the QRM.

R.f. gain control to prevent blocking of the regenerative detector preferably should be applied to the buffer tube, since regulation of the gain in this stage will not disturb the regeneration conditions in the tuned stage. If the grid bias on the tuned stage is varied to control the gain, the variation in mutual conductance of the tube is quite certain to affect the feed-back and thus pre-

vent the gain control from being independent of selectivity. Variable grid bias on the buffer tube to control gain has been used successfully in the receiver shown in the accompanying photographs.

#### A REGENERATIVE-R.F. RECEIVER WITH TWO-VOLT TUBES

After the successful application of the regenerative principle to the a.c. receiver, the construction of a portable outfit using two-volt d.c. tubes was undertaken. Two views of this set, with its carrying case, are shown in the photographs. The complete circuit diagram is given in Fig. 2. The line-up includes a regenerative r.f. stage with a 32, a 34 buffer tube, 32 detector, and two audio stages using 30's. Experiment indicated that smoother performance and better all-around action could be obtained with a 32 in the first stage than with a 34, which accounts for the choice of the non-variable- $\mu$  tube. In the buffer stage, the use of the 34 permits grid-bias control of gain. Two audio stages with 30's are used in preference to a single pentode

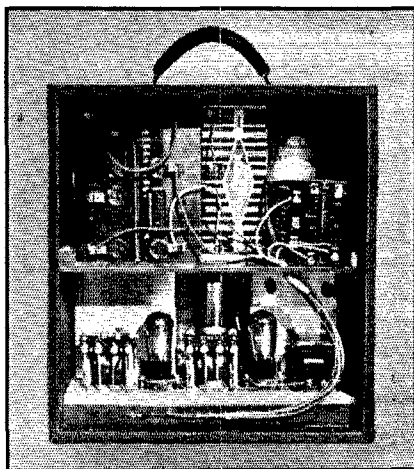

VERY LITTLE SPACE IS LEFT UNUTILIZED HERE

*This rear view of the portable receiver shows the audio stages and output transformer, as well as the battery compartment in the carrying case. The dimensions of the outfit can be judged by comparison with the "B" batteries, which are medium-sized 45-volt blocks.*

because of the lower filament drain. The five tubes in the receiver take a total filament current of only 300 milliamperes.

In the main the circuit conforms to ordinary practice. Band-spreading is secured by the two-condenser method, the tuning condensers being Hammarlund 5-plate midgets, and the "tank" or band-setting condensers 250  $\mu\text{fd}$ . each. Regeneration in the detector circuit is controlled by varying the screen voltage. The detector plate is parallel fed.

The plate circuit of the regenerative r.f. stage is rather odd-looking, but the set actually works well with the connections as shown.<sup>2</sup> Bias is applied to the grid of the 34 buffer through a radio-frequency choke, and can be varied to control gain by the potentiometer  $R_4$ . The antenna circuit is arranged for use with a doublet or

(Continued on page 118)

<sup>2</sup> This circuit arrangement provides no plate by-pass capacity except the grid-filament capacity of the following 34 tube and such stray capacity as may result from placement of circuit components. The grid-filament capacity of the 34 probably also acts as the impedance across which the output voltage of the r.f. stage is developed. The coupling arrangement of Fig. 1 should be tried if the circuit of Fig. 2 cannot be made to function as described.—EDROR.

# Greatest DX Contest Ever Staged

Over 80 Foreign Countries Participating—New Records—  
Many New WAC

**T**HE amateur has always been a visionary individual, but we wonder how many were optimists enough to predict correct results of the latest DX contest. Last year, with excellent conditions predominating, scores ran very high. This year, with more amateurs competing, QRM much greater, all past records in DX contests have been literally smashed to smithereens. Both foreign and American scores attained much higher levels than ever before.

As this story is being written, over 600 Canadian and American scores have been received—representative of all districts. Many stragglers will come through, so the present story can tell only the highlights as we see them at the moment. Scores that we record are not checked—they are approximate at the best. The actual checked figures and scores will be released in a later issue of *QST*. Our prime purpose is to record as soon as possible another high mark in the level of amateur achievements while it is still fresh in the memory of all participants.

At this time logs have been received from only a few foreign amateurs. Topping all others at the moment, the log of NY1AB, operated by G. Vandekamp, covers 12 pages of single-spaced typing and resembles a young callbook and U. S. Treasury Department record combined. Figures were exchanged with over 615 W and VE amateurs in fourteen districts, putting the final score well over 25,000! Always a busy station during

who worked over 550 W and VE stations for a grand total of over 22,000.

Outstanding scores were sent in by EA5BE and X1AM, totaling 15,000 and 11,300 points respectively. K4SA scored 11,100 points. Rumors are rampant of high scores by ZS2A, EA5BE, D4BAR and several G stations. Several ZL, VK and J stations must have run up tremendous scores. HP1A sends in a score of 7600 points for working 11 districts on 14 mc. only. CM1ML scored over 6000 points. As we go to press only a small percentage of foreign reports are at hand, so we shall concentrate upon W and VE scores and exchanges.

Outstanding in this latest triumph is the vein of hearty good sportsmanship displayed on all sides. Good keen competition is what all desired and, though many showed keen disappointment at their showing, all agreed that working DX is still a specialized branch of amateur radio requiring as much skill and affording as much pleasure as of old. Before moving on to high scores we wish to pay tribute to the fellows with their low power, low scores but "stick-to-itiveness," who garnered mighty few but precious points. Those stations deserve commendation, for we must all admit that when everything is going smoothly, with every other foreign station called being worked, it's fun—not disheartening work. Place yourself in the station of the amateur who, hour after hour, pleads with his "bruiser" to pierce some

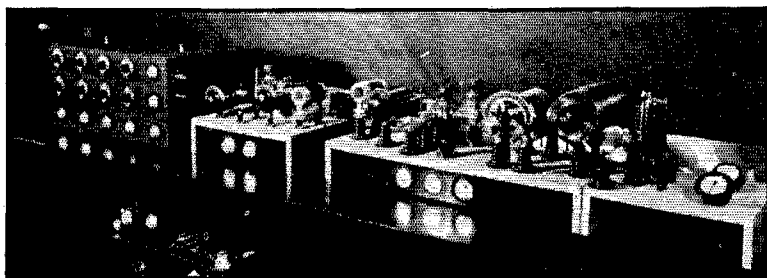

**W1ZI, CAMBRIDGE, MASS., WORKED 52 DIFFERENT COUNTRIES IN CONTEST PERIOD**

*This station, owned by Harris Fahnestock, Jr., has been doing consistent DX work for the past two years. Keeping schedules with KA1NA and ON4CSL and ever on the lookout for that Asian QSO keeps W1ZI on the qui vive. Crystal-controlled, ending with a pair of '52's with 1-kw. input, the station performance is kept at maximum efficiency with the aid of an s.s. receiver.*

the contest, NY1AB worked as many as 16 different stations an hour some hours. That in itself would be an excellent daily record for any W or VE station. Right behind this comes X1AA,

foreigner's—any foreigner's—eardrums. Reward may come but once or twice during a day, providing the operator hasn't become discouraged and the wax hasn't melted from all the overloaded

**W6CRA,  
CANONSBURG, PA.**  
Last year WAC 22 times  
and 10 times WAC this  
year, to date, Frank Lucas'  
station has an enviable DX  
record. The final '52 runs  
at 600 watts input.

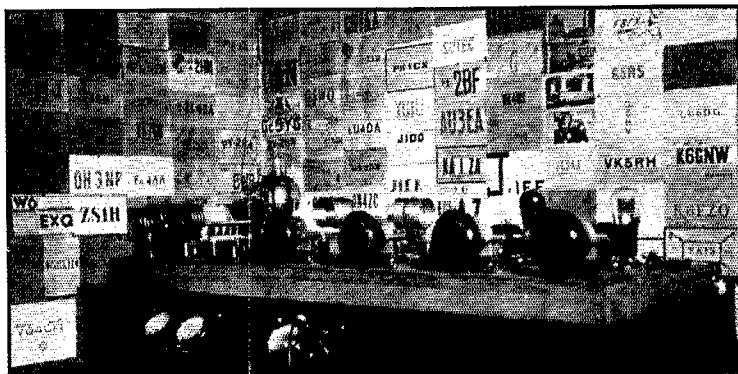

equipment. A letter we are reproducing seems to typify these men of zeal.

Editor, *QST*:

Well, the contest is over. Yessir, I had a great time—listening. Listening to the YI's, ZL's and

kc. there were at least 2 ether-busters. It sounded like everybody was using a kilowatt. Didy hear HC1LC? Boy, he was louder than my key clicks in the BCL set downstairs. True, he had a note like a saw mill, but he was taking down numbers like a New York "hello girl."

I figured to work a dozen countries with my 25 watts output—that would be swell. But why should a foreigner try to squeeze an R5 sig out between two R8 sigs? That's how my low-power philosophy went the way of that 281 I dropped on the floor last week.

So, I've started saving my nickles. When the annual contest of 1944 rolls around I'll be the guy. Yessir, at least a pr. of 04's—high power for me—blot out the other guy—that's the answer, brute force. I'm gonna be putting out so much soup I'll have to use trolley wire for my antenna.

But I'm not proud—here's my score for the '34 contest.

—Burke Edwards, W3BKZ, Chevy Chase, Md.

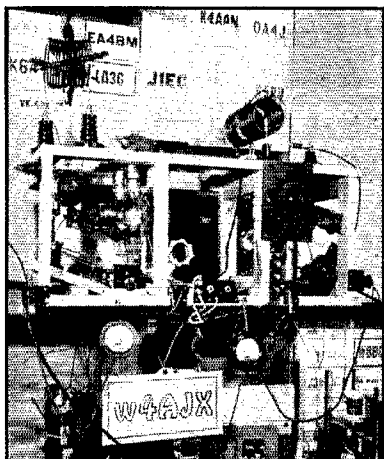

**W4AJX, TAMPA, FLA., SETS NEW WAC RECORD**

Not content with DX in the contest, L. E. Benjamin kept after it, and on April 1st all continents were contacted in 59 minutes! The stations contacted were: EA3AN, J2HI, W4TZ, OA4AA, ON4CSL and K6COG. The work was all done on the 14-mc. band. The transmitter is crystal-controlled, using a pair of '52's in the final stage with 1-kw. input.

the rest of 'em. Oh sure, I've a transmitter. Xtal controlled with a coupla 59's in p.p. for the final amplifier.

... "Low power," sez I, "that's the idea—low power. What's the fun in working DX if you're using a couple 861's? Anybody can do that."

... I finished the xtal set a week before the contest. And did I get a kick out of working an SM on that 8 a.m. CQ? You said it! Then came the contest of 1934. I hadn't figured on one point: The 20-meter band is 400 kc. wide, and for every

Such a letter might well be titled, "Dreams of Every Amateur at One Time or Other." And then there is the case of the chap who contacted seventeen countries in the two months previous to the contest who, during the entire tests, did not have a single contact! Discouraged? Not a bit. Many similar cases were reported. Our hats off to these chaps—for it is they who garner the real thrills of amateur radio.

Madhouse from the start, March 10th, 0000 found foreigners clamoring for a contact with any American or Canadian station. This mad scramble increased day by day as more foreigners became more enthused. And for every new foreign amateur at least 500 new stations on this side would sprout up to receive him. That certainly seemed to be the case. How many foreign stations were active? We dare not estimate, but from actual logs we know that over 80 foreign countries were represented. We know of one operator on the East Coast who operated leisurely during spare hours and called over 350 different amateurs in 58 countries. DX? What is DX? We dare not answer

that. The writer has been working foreign amateurs since 1924, and disappointment has yet to register from working a foreign station, regardless of the distance.

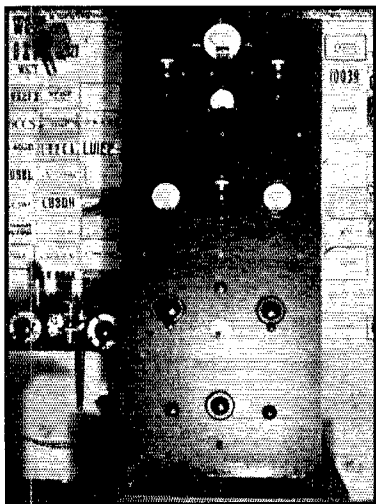

**W8ZY, DEFLANCE, OHIO**

Karl Duerk dates his station back to 1914. Originally SAHI, later 8AA, 8ZY was acquired as a special license shortly after the War. Described originally in 1920 QST's, the present layout (quite different) ends up with a pair of '52's with 750 watts input.

Many are the solutions of "the way I'm going to win the contest next year." We recall the experience of one rather successful operator who figured success would crown his efforts if he disregarded the stronger foreign amateurs at the start, going only for the weak stations, since they would be less popular. This seemed to work out beautifully for the first few days, until it was time to reverse tactics. There they were—R8-9 amateurs—all DX, all unworked, easy picking. Yes? It happened that these same amateurs were looking to greener fields, trying to fill the gaps in their district multiplier, willing to sacrifice points to this end. The operator relating this experience admits that this almost proved disastrous.

From reports already in we have gathered much interesting information on sidelights and highlights of foreign operators and their habits. Some of these we shall relate. G6QB and XI1ER had a constant and never-failing supply of W and VE stations with whom to carry out various experiments. G6QB mentions that he used a different antenna every day and was able to do some very interesting work. That's one way of carrying out experiments, even though we did happen to be the guinea pigs! CM2OP, 13-year-old Cuban, was rattling it off with the best of them. Heard on both 7 and 14 mc. he was always QSO—

always in a hurry. Many stations comment that more stations called ZS2A than any other foreign station. DX to any of us, ZS2A with his purported 30 watts could be heard every evening right on the bottom of our 7-mc. band. Many times during an evening all W districts could be heard calling this popular station at one time! To those unable to work ZS2A, ZS2F, ZU1E, ZU6E and ZT5R proved lifesavers. The night before the end of the contest ZS2A reported his 217th contact. When one reflects that every single one of those contacts was over at least 6000 miles ZS2A certainly covered many a mile.

Speaking of miles, we recall the 7-mc. band each morning literally covered with VK and ZL stations for four hours. These stations with their beautiful sigs for the most part were traveling along at 15 w.p.m.—increasing speed day by day, until the last morning we venture to say that ZL4AI and ZL4AO were hitting a 30-word clip and doing better than a contact every 5 minutes! Thrills? Harken back to 1924—ten years ago—when it was front page news to even hear a station in New Zealand. Later, a station in our home town worked one, followed by another, all in one morning. This was the first time that an American amateur had ever conversed with more than one New Zealand station in a single morning. Scanning over a few logs we come across W8ZY's log which shows 11, W7CPC shows 13, while W6QD had 21 contacts with ZL and VK stations in a single morning.

This contest, probably more than any other to date, gave the amateur with the selective s.s. receiver a premium that was much more valuable than extra power in the antenna. Signals such as FF8SUD, ON4CSL, VQ4CRO, OE1ER and

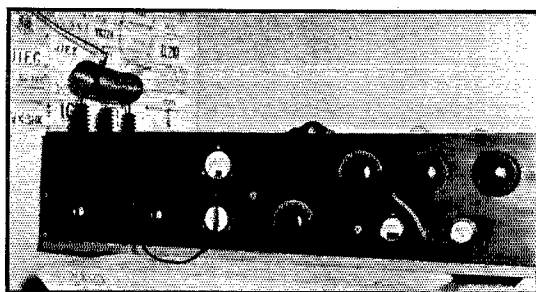

**W6FYT, ONTARIO, CALIF.**

The present transmitter ends up with a pair of '52's at 1-kw. input. W. H. Jones started with spark-coil BJ in Pittsburg, Kansas, in '19—the present station not coming on the air until January, 1934.

SU1EC were picked out of the background, and some of these same signals were absolutely buried in the background without the use of a crystal filter. Which brings up another point. Many suggestions were sent in for future contests. Among them many insist that the high-powered

(Continued on page 122)

# A 500-Watt Transmitter in the Modern Manner

The Details of a Well-Dressed Assembly Providing Three-Band Operation Without Coil Changing and Complete Provision for Remote Control and Overload Protection

By Albert H. Jackson, W1NI\*

When an amateur starts out to build himself a permanent transmitter of any size, there are bound to result some constructional and circuit features which will be of interest and benefit to others. While not everyone will find it possible to duplicate the 500-watt transmitter described in this article, a reading of the text and inspection of the diagrams will reveal a number of highly valuable ideas which can be applied with equal success to any set, no matter what its power rating.—EDITOR

IT HAS always been the ambition of W1NI to construct a transmitter of ample power, simple to operate and complete in one rack or cabinet, but with all parts accessible so that changes and repairs could be made from time to time. With this thought in mind apparatus such as meters, dials, switches, tubes, and various other parts have been collected and stowed away for the past few years. The thing that was most difficult to acquire, however, was a suitable rack or cabinet that would be shielded, strong, with good appearance—and above all be reasonable enough in price to fit a normal pocket-book. This problem was finally solved for me when the Westinghouse Company offered their transmitter cabinet in October, 1933, *QST*. This was exactly what I had been looking for, so one was purchased and the construction of the transmitter was soon under way.

In determining the transmitter tube line-up, various considerations led to the selection of two tubes of the 1000-volt 100-watt output classification for the final stage. As most amateurs know, two tubes of this type,

\*8 Plymouth Road, W. Hartford, Conn.

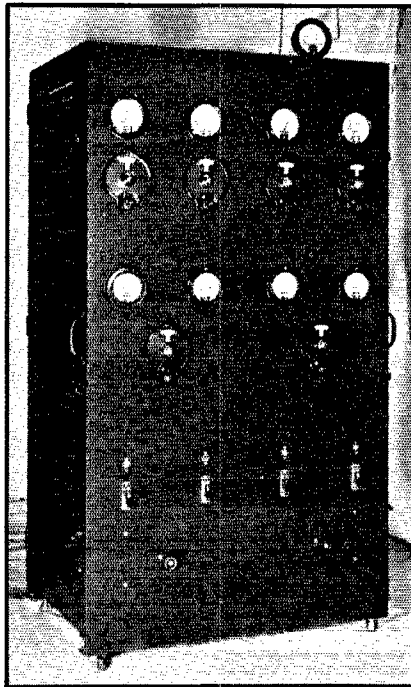

FIG. 1—A TRANSMITTER DRESSED UP LIKE THIS SHOULD BE INSPIRED TO DO ITS UTMOST

The panel layout of W1NI's 500-watt c.w. transmitter. The r.f. ammeter is mounted on the lead-in insulator because of the difficulty of insulating it adequately from the metal panel.

properly excited, are capable of handling a half kilowatt input without pushing them very far beyond their nominal ratings. Designing the circuit then became primarily a matter of making sure that the final stage would have plenty of excitation on the three bands to be worked—3.5, 7 and 14 mc.—starting out from a 3.5-mc. crystal oscillator. Some thought was also given to the question of making band-changing a fairly simple proposition, and as finally built the transmitter covers all three bands with only one set of tank coils. In addition, since circumstances made it necessary to operate the set by remote control, it was necessary to work out the details of a control system which would reduce the number of manual operations to a minimum and be practically failure-proof in operation.

As eventually decided upon, the tube complement of the transmitter includes a 59 tri-tet oscillator, a 10 buffer stage, and a 511 buffer-doubler, this last tube driving the two 511's in the final amplifier. One of the newer 50-watt tubes would have been equally capable of operating as a driver for the final stage, but an extra 511 was already in the writer's possession and its use

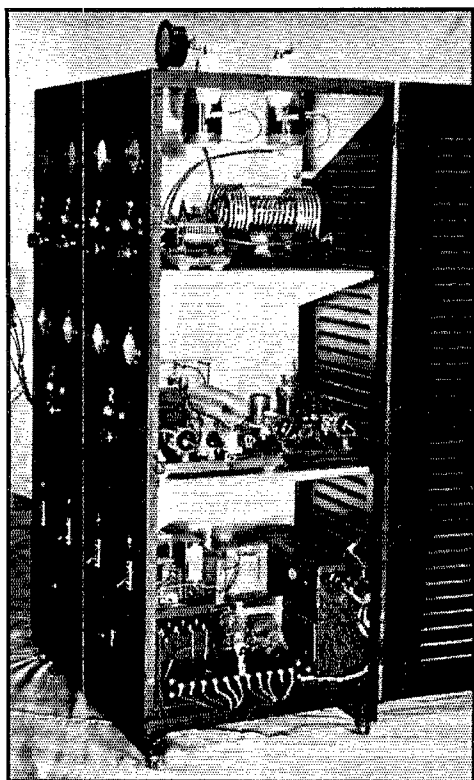

FIG. 2—THE TIER OF COMPARTMENTS ON THE RIGHT-HAND SIDE CONTAINS THE LOW-VOLTAGE POWER SUPPLIES, OSCILLATOR AND BUFFER, AND THE ANTENNA-TUNING APPARATUS

made the purchase of another tube unnecessary. More than enough excitation is available for the last stage, and since the 511 driver is underloaded the chances of long life are excellent.

#### THE RADIO-FREQUENCY CIRCUITS

The complete circuit of the radio-frequency part of the transmitter is given in Fig. 3.

The 59 tri-tet oscillator was selected because of its high harmonic output and the ease with which it oscillates. The plate coil and condenser are proportioned so that they tune to both the 3.5- and 7-mc. bands with one swing of the dial. When the output of the oscillator is on 3.5 mc. the cathode coil is shorted out by bending over a corner of one rotary plate of  $C_1$  so that it touches the stator when the condenser is set at maximum. A triple crystal holder and a three-point switch permit a choice of three frequencies. Two crystals, 20 kc. apart, are now in use and the switch can be shifted from one to the other without retuning any part of the set. The feeder current is exactly the same on all bands with either crystal.

The 10 stage following the tri-tet is used as a straight amplifier on both the 3.5- and 7-mc. bands. It is the conventional neutralized 10 amplifier and was selected as being the most suitable driver for the following stage. Its coil and condenser also tune to both bands with one swing of the dial. Grid-leak bias is used on this tube, the amount of bias being regulated by the variable resistor,  $R_4$ , connected from grid to ground. A closed-circuit jack is connected in series with this resistor so a meter can be plugged in to read grid current.

The second amplifier-doubler is a deForest 511 tube in the circuit using a split-stator condenser with grounded rotor, and

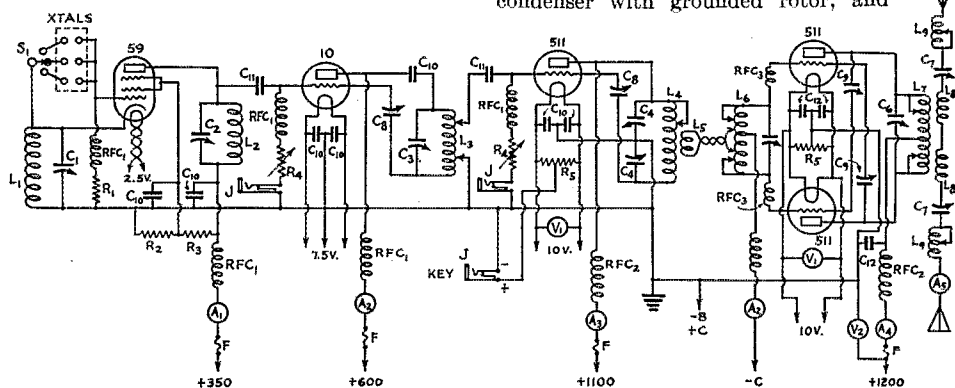

FIG. 3—THREE-BAND OPERATION WITHOUT CHANGING COILS IS A FEATURE OF THIS CIRCUIT

- $C_1$ ,  $C_2$ —320- $\mu$ fd. midget variable (Hammarlund)
- $C_3$ —500- $\mu$ fd. variable (General Radio Type 247)
- $C_4$ —250- $\mu$ fd. split-stator (two G.R. 247 condensers in series on same shaft)
- $C_5$ —250- $\mu$ fd. variable (Cardwell) (This condenser tunes the grid circuit of the final amplifier)
- $C_6$ —250- $\mu$ fd. variable, triple-spaced
- $C_7$ —250- $\mu$ fd. variable, double-spaced
- $C_8$ —25- $\mu$ fd. double-spaced (23-plate Pilot midget with alternate plates removed)

- $C_9$ —50- $\mu$ fd. variable (Cardwell Midway)
- $C_{10}$ —0.02  $\mu$ fd.
- $C_{11}$ —250  $\mu$ fd., 5000-volt rating
- $C_{12}$ —0.02  $\mu$ fd., 5000-volt rating
- $R_1$ —100,000 ohms, non-inductive, 2-watt rating
- $R_2$ —5000 ohms, 5-watt rating
- $R_3$ —10,000 ohms, 5-watt rating
- $R_4$ —500-ohm variable (Bradleyohm)
- $R_5$ —100-ohm c.t. resistor, (two 5-watt, 50-ohm resistors)

(Continued at foot of next page)

neutralized from one end of the condenser to the grid. This circuit, described in January, 1934, *QST*, works out very well, and the amplifier delivers more than enough excitation to the final stage on all bands. It is used as a straight amplifier on 3.5 and 7 mc. and as a doubler on 14 mc. The tank condenser capacity is such that both 3.5 and 7 mc. can be hit with one tank coil; to double to 14 mc. half the coil is shorted out with a clip. The bias for this tube is obtained partly from a variable grid leak,  $R_4$ , and partly from the voltage drop through a 2300-ohm relay which is connected in the center tap in series with the key as will be explained later. A closed circuit jack in series with the leak for reading grid current is provided in this stage.

Excitation is fed from this stage to the final amplifier by link coupling. A small coil,  $L_5$ , coupled to one end of the tank coil,  $L_4$ , is connected to a piece of twisted lamp cord which terminates in two clips. These are attached to the final grid coil,  $L_6$ , one turn each side of the center tap. This arrangement works very satisfactorily and assures maximum energy transfer, since the excitation is readily adjustable.

The final amplifier uses a pair of deForest 511 tubes in push-pull. The plate tank coil,  $L_7$ , is located in a separate compartment of the cabinet to guard against the possibility of coupling between the grid and plate circuits. Since the antenna coils are also in the same compartment this arrangement makes the coupling to the antenna circuit quite convenient. The grid and plate tank circuits in this amplifier also tune to both 3.5 and 7 mc. with one swing of the dial. On 14 mc. about half of each coil is cut out by clips which short circuit the end turns, as indicated by Fig. 3. Since the preceding stage is keyed, it is necessary to use fixed bias on the final amplifier, in this case supplied by a 180-volt "B" eliminator with a 5000-ohm resistor connected across its terminals. A d.c. milliammeter is permanently connected in the grid circuit; it is highly useful during tuning and serves to check the excitation at all times.

RFC<sub>1</sub>—National Type 100 choke  
 RFC<sub>2</sub>—National Type R-152 choke  
 RFC<sub>3</sub>—10 turns No. 14 wire, wound on pencil  
 J—Single closed-circuit jack  
 F—Littelfuses

$L_1$ —15 turns No. 22 d.s.c. on 1½-inch diameter form, winding length 1½ inch

$L_2$ —12 turns No. 22 d.s.c. on 1½-inch diameter form, winding length 1½ inch

$L_3$ —16 turns ⅜-inch copper tubing, diameter 2½ inches

$L_4$ —20 turns ⅜-inch copper tubing, diameter 3¼ inches

$L_5$ —4 turns ¼-inch copper tubing, diameter 3 inches

$L_6$ —18 turns ⅜-inch copper tubing, diameter 2¾ inches

$L_7$ —20 turns ¼-inch copper tubing, diameter 2½ inches

$L_8$ —6 turns ¼-inch copper tubing, diameter 4 inches

$L_9$ —20 turns No. 12 enameled on 3-inch diameter form, turns spaced with string

$A_1$ —0–150 d.c. milliammeter

$A_2$ —0–200 d.c. milliammeter

$A_3$ —0–250 d.c. milliammeter

$A_4$ —0–600 d.c. milliammeter

$A_5$ —0–5 r.f. ammeter

$V_1$ —0–15 a.c. voltmeter

$V_2$ —0–2500 d.c. voltmeter

$S_1$ —Three-point switch, single pole

The antenna circuit consists of a pair of coupling coils mounted around the ends of the plate tank. A double-spaced condenser and a tapped loading coil are connected in each feeder lead. For 3.5-mc. operation the antenna described by WIEDY in June, 1933, *QST*, is used, and on 7 and 14 mc. a 66-foot Zepp with 18-foot feeders.

#### CABINET LAYOUT

The cabinet is provided with three shelves on each side of the central vertical shield, making six compartments in all. With the doors shut, each compartment is completely shielded—a decided advantage in a multi-stage transmitter in that it helps to eliminate interstage coupling.

Although the shelves are removable, it was decided to build each unit of the transmitter on a separate breadboard, each equipped with rubber feet. This arrangement allows each stage to be removed easily and quickly when repairs or changes are necessary. All condenser shafts are insulated by couplings and this, together with the rubber feet on the breadboards, makes each unit entirely insulated from the cabinet.

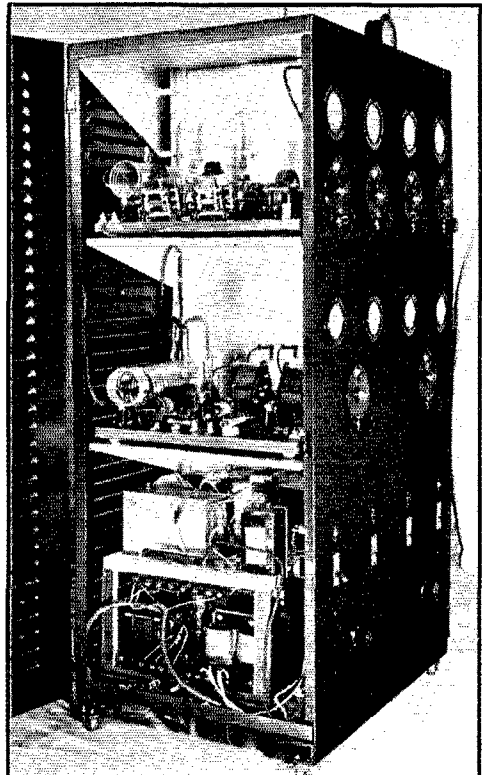

FIG. 4—HIGH-VOLTAGE POWER SUPPLIES, THE 511 BUFFER-DOUBLER, AND THE PUSH-PULL FINAL AMPLIFIER OCCUPY THE LEFT-HAND SIDE OF THE CABINET

The arrangement of the right-hand side of the cabinet is shown in Fig. 2. On the lower shelf are the power supplies for the oscillator and 10 buffer, and the "B" eliminator which provides bias for the final stage. The middle shelf contains the tri-tet oscillator and 10 buffer, each on separate breadboards, and on the top shelf are the antenna loading coils, antenna coupling coils, final stage tank coil and antenna tuning condensers.

The high-power equipment is located in the left-hand side of the cabinet, shown in Fig. 4. The power supplies for the driver and final stages occupy the lowermost compartment. The 511 buffer-doubler is on the center shelf, and the push-pull 511 stage with its grid tank circuit and plate tank condenser are in the upper compartment. Leads from the plate condenser run through insulated bushings in the vertical shield to the plate tank coil, located in the antenna tuning compartment on the right-hand side. The input and output coils are thereby very effectively shielded from each other.

#### POWER SUPPLIES

Fig. 5 is a diagram of the power-supply and power-control wiring. There are three plate supplies, one for the oscillator and first buffer, one for the 511 buffer, and the third for the final stage. The low-voltage supply uses an 82 rectifier and is equipped with a choke-input filter; a variable resistor,  $R_{12}$ , in the primary circuit of the plate transformer permits a wide range of control of plate voltage. The plate supply for the 511 buffer has an 83 rectifier with a condenser-input filter. Under normal load the output voltage of this power supply is 1100 volts; the actual voltage applied to the 511 is about 900, because of the drop through the relay in the center tap.

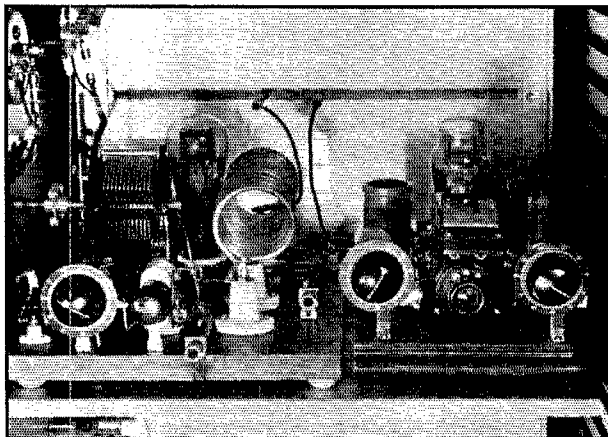

THIS CLOSE-UP VIEW SHOWS THE OSCILLATOR AND BUFFER UNITS

Excitation leads to the 511 stage run through the insulating tubes in the vertical shield. In this compartment, only the buffer tuning control is brought out to the panel. The separate breadboard type of construction makes all units easily accessible.

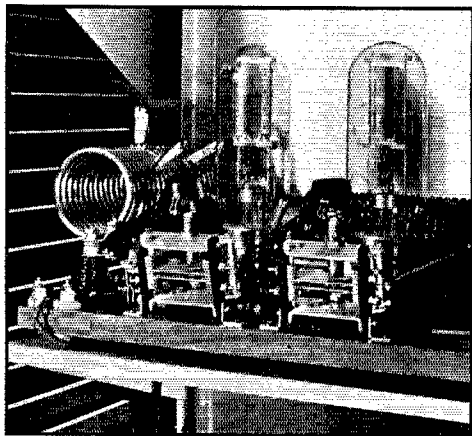

BAND-CHANGING IS AN EASY MATTER WITH THIS TRANSMITTER

This glimpse of the final-stage compartment shows the tubes, neutralizing condensers, and the grid tank coil with its excitation and short-circuiting clips. The losses introduced by shorting turns for 14-mc. operation are inconsiderable.

The final stage plate supply uses a pair of 866 rectifiers, also with a condenser-input filter. A primary rheostat gives a wide range of control of plate voltage. Ordinarily the plate voltage is 1200 at a load of 350 to 400 milliamperes.

In Fig. 2 the lower shelf in the right-hand side of the cabinet contains the apparatus to the left of the key switches in Fig. 5, including the "B" eliminator used as bias supply on the final stage and the signal-light transformer. The baseboard on the lower shelf in Fig. 4 is double decked; on the lower deck is the supply feeding the single 511 amplifier, and on the upper deck the supply

for the final amplifier. Base boards are supplied with rubber feet and terminal strips, the latter being connected to cables which run to the different stages. At the end of each cable is a Yaxley plug which fits into a corresponding socket mounted on each of the amplifier baseboards, thus enabling the stage to be removed easily without the necessity of disconnecting a large number of wires. Two small insulators mounted on the front of each power supply serve as the primary rheostat connection terminals.

The four key switches in Fig. 5 function as follows: Switch No. 1, the upper switch in the diagram, and at the right-hand side of the panel in the front view photograph of the transmitter, controls the 110 volts to the filament transformer primary windings, the bias "B" eliminator, keying-tubes filament transformer,



and the signal light transformer. The second, third and fourth switches are fed 110 volts from the upper switch when it is in the closed position. Each switch then in turn closes the primary circuits of the three plate transformers. In this way the first switch acts as an interlock to prevent the plate voltage from being accidentally turned on before the filaments are lighted. The small signal lights located above the switches are operated in the same sequence from the same switches. A small single-pole switch is connected in the plus "B" lead to the 10 amplifier so that the plate voltage may be cut when neutralizing. In neutralizing the other stages the key switches on the panel are used for this purpose.

#### REMOTE CONTROL AND KEYING

Since the transmitter is located in the attic and the operating position is on the floor below, remote control is a necessity. Four wires are required for the remote-control system. Two of these are used to operate the relay  $RY_4$  in Fig. 5. This relay is

(Continued on page 104)

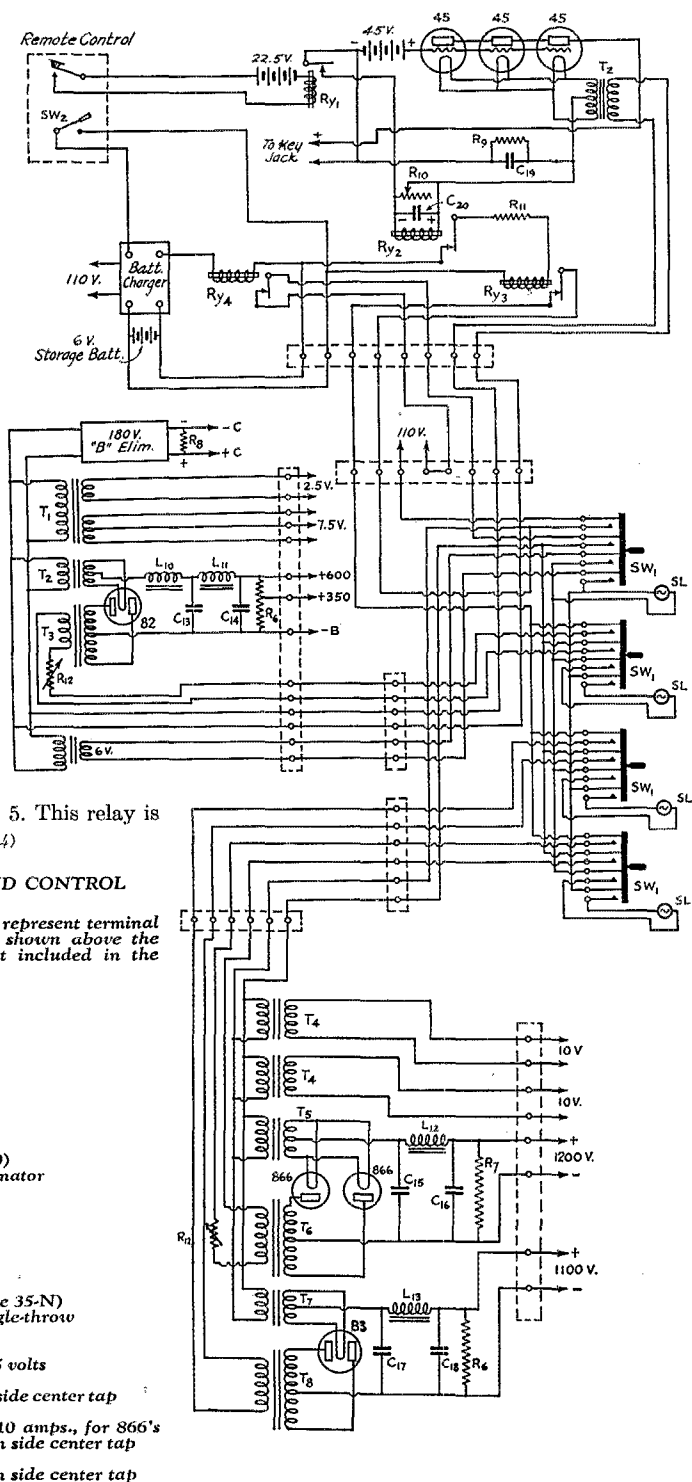

FIG. 5—POWER SUPPLIES AND CONTROL APPARATUS

Dotted enclosures on this diagram represent terminal strips. The remote-control circuit is shown above the uppermost terminal strip and is not included in the transmitter cabinet.

- $C_{13}, C_{14}$ —4  $\mu$ d., 800-volt condenser
- $C_{15}$ —4  $\mu$ d., 1500-volt condenser
- $C_{16}$ —5  $\mu$ d., 1500-volt condenser
- $C_{17}$ —2  $\mu$ d., 1500-volt condenser
- $C_{18}$ —4  $\mu$ d., 1500-volt condenser
- $C_{19}$ —1  $\mu$ d., 400-volt condenser
- $C_{20}$ —1000  $\mu$ d., 16-volt condenser
- $L_{10}, L_{11}$ —30-henry, 150-ma. choke
- $L_{12}$ —15-henry, 500-ma. choke
- $L_{13}$ —20-henry, 200-ma. choke
- $RY_1$ —100-ohm relay (W.E. type 22-A)
- $RY_2$ —2300-ohm relay (W.E. type B-320)
- $RY_3$ —Relay from old Philco A-B eliminator
- $RY_4$ —Relay from old battery charger
- $R_6$ —50,000 ohms, 75 watt
- $R_7$ —60,000 ohms, 75 watt
- $R_8$ —5000 ohms, 25 watt
- $R_9$ —1 megohm, 1 watt
- $R_{10}$ —500-ohm variable resistor
- $R_{11}$ —20-ohm rheostat
- $R_{12}$ —16 ohm power rheostat (W.E. type 35-N)
- $SW_1$ —Federal key switches, 4-pole single-throw
- $SW_2$ —Single-pole toggle switch
- SL—Signal lights
- $T_1$ —Filament transformer, 7.5 and 2.5 volts
- $T_2$ —Filament transformer, 2.5 volts
- $T_3$ —Plate transformer, 800 volts each side center tap
- $T_4$ —Filament transformer, 10 volts
- $T_5$ —Filament transformer, 2.5 volts, 10 amps., for 866's
- $T_6$ —Plate transformer, 1000 volts each side center tap
- $T_7$ —Filament transformer, 5 volts
- $T_8$ —Plate transformer, 800 volts each side center tap

# The Regenerative S. S. Receiver Brought Up to Date

A Six-Tube Version Incorporating Pre-Selection

By R. W. Woodward, W1EAO\*

Even though it is now featured in the current edition of *The Radio Amateur's Handbook*, demand persists for more on the economical regenerative type S. S. Superhet originally presented in April, 1933, *QST*. This article by Dr. Woodward, describing his improved model, adequately fills the bill.—EDITOR

THE writer's requirements in a receiver are probably as severe as those of most other amateurs. The station is located in a beehive of amateur activity, with some 25 transmitters within a radius of a mile or so, some using inputs up to a kilowatt. Two or three stations about a block distant have blanketed practically an entire amateur band with the more usual types of receivers. These conditions, together with the presence of a local 50-kw. broadcast transmitter, make necessary a superheterodyne receiver with high "local" selectivity.

Hence the receiver had to be a single-signal superhet, not only to meet this high "local" selectivity requirement but also to reduce the general QRM and noise. Experience has shown that with this type receiver the effective frequency width of the amateur bands is more than doubled while, by noise reduction, the effective

ment that there must be no possibility of high-frequency image response to confuse the results; hence a stage of r.f. pre-selection, supplemented by a positive image test to be described later, to take care of this requirement. As is also necessary in frequency observation work, the receiver must have complete frequency coverage and not be limited solely to the amateur bands. Finally, the cost of the receiver had to be reasonable.

These several requirements pointed to the regenerative Single-Signal superhet plus a stage of pre-selection; and the receiver here described is the result. The circuit line-up is as follows: Tuned r.f. stage, first detector, electron-coupled high-frequency oscillator, regenerative i.f. stage with variable high selectivity, power pentode second detector and electron-coupled c.w. beat oscillator. For details on the theory of operation the reader is referred to the description of the original receiver in *QST* and *The Radio Amateur's Handbook*. In this instance the receiver has been designed to be reasonably compact, making use of readily available components.

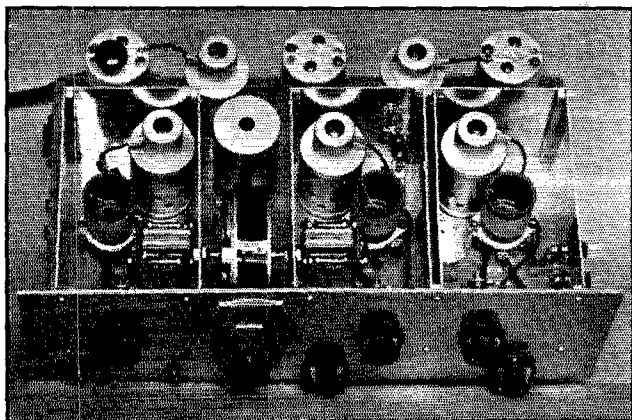

FROM THE FRONT WITH THE COVER OF THE STAGE SHIELDS REMOVED

Controls and components are identified in the text.

sensitivity is bettered by five times or more.

Official observer activity in checking off-frequency stations especially imposed the require-

\* 194 Warrenton Ave., West Hartford, Conn.

## THE LAYOUT

The accompanying photographs show the general arrangement and Fig. 1 gives the wiring diagram. The left-hand shield compartment contains the high-frequency oscillator with a 57 tube. Directly behind the drum dial is the 2A5 pentode second detector. In the center compartment is the 58 first detector and its tuning circuits, with the oscillator coupling condenser, while in the right-hand compartment is the 58 r.f. pre-selector-amplifier.

On the back deck, at the extreme left, is the c.w. beat oscillator coil and condenser unit,  $T_3$ , with the beat control knob projecting at the top. Next is the 58 c.w. beat oscillator tube. The center can contains the i.f.

transformer assembly,  $T_2$ , with the 58 i.f. amplifier to its right. At the extreme right is the regenerative i.f. transformer assembly,  $T_1$ .

Looking at the front of the panel, the upper row of knobs are, left to right: h.f. oscillator tank,  $C_5$ ; first detector tank,  $C_4$ , and r.f. tuning condenser,  $C_1$ . At the bottom of the panel, the left-hand switch,  $SW_1$ , controls the high voltage supply to the receiver. Next is the c.w. beat oscillator "on-off" switch,  $SW_2$ , cutting the screen voltage. The knob below the illuminated dial is the main tuning control operating the ganged condensers  $C_2$  and  $C_3$ , with the gain control,  $R_3$ , next. The knob at the right operates the i.f. selectivity control, the regeneration attenuator  $R_2$ .

Doublet antenna connections are made to insulated binding posts on the outside shield of the r.f. stage, with the ground binding post nearby on the main deck. With a conventional single-wire antenna connected to one insulated post, the other is connected to ground. Of course the doublet antenna should be used if possible, since it makes possible considerable additional gain.

Insulated 'phone tip jacks on the left end of the chassis provide connections for 'phones and speaker.

No apology is offered for the non-symmetrical location of the tuning dial. In operation it is a very pleasing arrangement. Once the tank condensers have been set for a given band, the selectivity adjusted to the desired degree, and the c.w. beat note fixed, the receiver is in effect single-dial tuning with operating controls for volume, frequency and c.w. note convenient for one position of the hand.

#### CHASSIS CONSTRUCTION

The structural part of the receiver is all of sheet aluminum. The chassis or main deck is made from a piece of 3/32-inch aluminum 21 inches by 12 inches. From two corners on one long side of this piece, 2-inch squares are cut out and then three sides are bent down at right angles so as to form the sides and back of a deck 17 by 10 inches and 2 inches high.

All of the inter-stage box shields are cut from 1/16-inch aluminum. The six sides are 7 inches long by 4 3/4 inches high, while the three ends are 4 1/4 inches wide by 4 3/4 inches high. The shields are held together at the corners by 1/4-inch square brass rods drilled and tapped for 6/32 machine screws. The corner posts are fastened to the main deck by screws into their lower ends.

The front panel is of 1/8-inch thick aluminum,

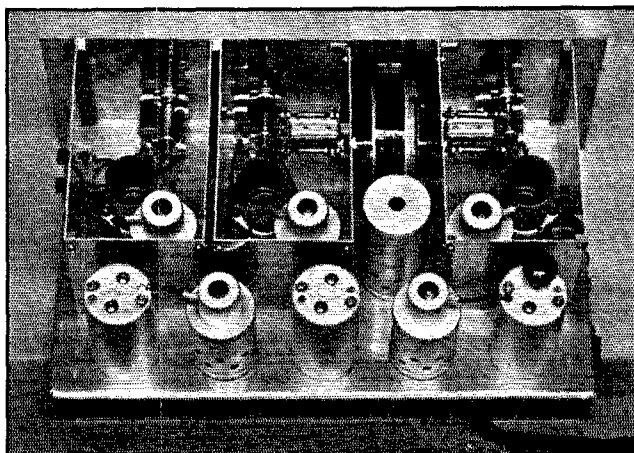

AS VIEWED FROM THE REAR, SHOWING THE I.F. UNIT LOGICALLY ASSEMBLED ALONG THE BACK DECK

18 inches long by 7 inches high. It is fastened by screws to the front posts of the shield boxes. Should it be desired to use the receiver in a standard rack mounting, the width of the front panel can be made 19 inches. The cover over all the shields is a sheet of 1/16-inch aluminum 16 inches by 7 inches held in place by flat springs on its under side, pressing against the sides of the shield boxes.

The construction of the aluminum work will be much simplified if the sheets are taken to a tin shop and cut accurately to size on foot or power shears and the sides of the deck formed on a bending machine. This will take a tinsmith only a few minutes and will result in a much better appearing finished job, to say nothing of the time saved. The tinner may also have equipment for punching out the 1 1/2-inch diameter holes for the tube sockets.

In drilling and tapping the holes required, use only sharp drills and taps, and use turpentine as a lubricant for cutting the aluminum and oil for the brass. With these simple measures it is surprising how quickly the work can be accomplished.

The Isolantite five-prong coil sockets are mounted above-deck on pillars long enough to clear the contacts. Similar tube sockets (six-prong) are mounted below the base under their 1 1/2-inch holes. With this arrangement a minimum of wires need pass through the base. Complete tube shields are provided for all tubes. A 1/2-inch length of 1/8-inch rubber tubing slipped over each grid wire, before soldering on the grid clip and afterwards pushed up on the clip, prevents any possible grounding of the grid on the grid-cap shield.

#### ADAPTING THE I.F. TRANSFORMERS

The National 500-ke. i.f. units each require minor alterations to adapt them to the circuit,

and they should be removed from their cans for this purpose. The first operation is on the regenerative i.f. transformer,  $T_1$ .

As supplied, the grid coil,  $L_7$ , is at the upper end of the dowel, nearest the condensers, and the plate coil at the bottom. In order to couple the tickler coil,  $L_8$ , to the grid coil, the external connections from the unit  $T_1$  must be changed so that the grid coil is the lower one. This means that one of the wires that normally passes out through the bottom of the can should be brought out the top through a piece of shield braid; and the wire originally at the top is brought out through the bottom.

A one-inch length of  $\frac{1}{2}$ -inch dowel is fastened

by means of a wood screw to the end of the dowel carrying the coils in the unit. At the lower end of the new dowel, the tickler  $L_8$  is bunch-wound with 25 turns of No. 30 d.s.c. wire. If this tickler is wound in the same direction as the other coils, the final connections from  $T_1$  are as follows: Inside end of upper or plate coil  $L_6$  to B+, outside to first detector plate through shield braid; inside end of middle or grid coil  $L_7$  to ground, outside through shield braid from top of can to grid cap of i.f. amplifier; inside end of lower or tickler coil  $L_8$  to i.f. suppressor, outside end through shielded lead to i.f. cathode. If the i.f. circuit cannot be made to oscillate with  $R_9$  in the maximum resistance position or disconnected, then the tickler

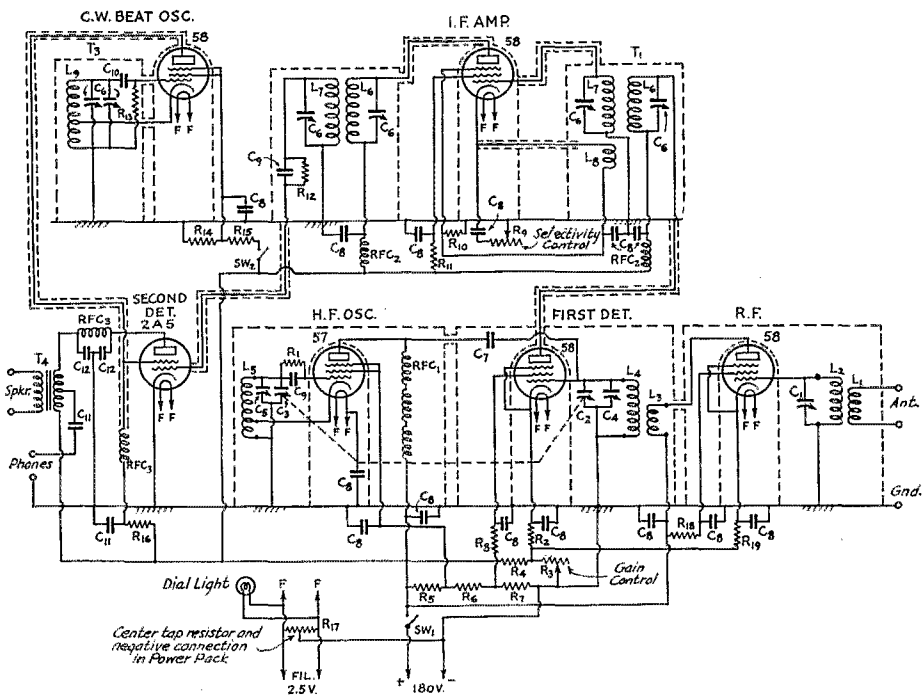

FIG. 1—CIRCUIT OF THE SIX-TUBE REGENERATIVE S.S. RECEIVER

- $L_1, L_2, L_3, L_4$  and  $L_5$ —See coil table.
- $L_6$  and  $L_7$ —500-kc. i.f. transformer windings.
- $L_8$ —See text.
- $L_9$ —500-kc. beat oscillator coil. (See text.)
- $C_1$ —140- $\mu$ fd. midget condenser (Hammarlund MC-140M).
- $C_2, C_3$ —25- $\mu$ fd. midget condenser (National SE-50 cut down to 3 stator plates).
- $C_4, C_5$ —100- $\mu$ fd. midget condensers (Hammarlund MC-100M).
- $C_6$ —70- $\mu$ fd. midget condenser (in National i.f. units).
- $C_7$ —H.f. oscillator coupling condenser. (See text.)
- $C_8$ —0.01- $\mu$ fd. r.f. by-pass condensers, tubular paper.
- $C_9$  and  $C_{10}$ —250- $\mu$ fd. mica grid condensers.
- $C_{11}$ —1- $\mu$ fd. audio by-pass and coupling condensers.
- $C_{12}$ —250- $\mu$ fd. plate by-pass condensers, tubular paper.
- $R_1$ —50,000-ohm 1-watt oscillator grid leak.
- $R_2$ —5,000-ohm 1-watt first detector cathode resistor.
- $R_3$ —12,000-ohm variable resistor, right-hand taper (Electrad).
- $R_4$ —100,000-ohm 1-watt.
- $R_5$ —10,000-ohm 5-watt.
- $R_6$ —7,000-ohm 2-watt.

- $R_7$ —3,000-ohm 2-watt.
- $R_8$ —50,000-ohm 1-watt.
- $R_9$ —2,000-ohm variable resistor, left-hand taper (Electrad).
- $R_{10}$ —300-ohm 1-watt (i.f. amplifier cathode resistor).
- $R_{11}$ —50,000-ohm 1-watt.
- $R_{12}$ —1-megohm  $\frac{1}{2}$ -watt second detector grid leak.
- $R_{13}$ —50,000-ohm  $\frac{1}{2}$ -watt beat oscillator grid leak (Integral with National oscillator unit).
- $R_{14}$ —2,500-ohm 2-watt.
- $R_{15}$ —50,000-ohm 2-watt.
- $R_{16}$ —2,500-ohm 5-watt.
- $R_{17}$ —20-ohm center-tap resistor (in power supply).
- $R_{18}$ —50,000-ohm 1-watt.
- $R_{19}$ —300-ohm 1-watt r.f. cathode resistor.
- $T_1$  and  $T_2$ —National 500-kc. air-tuned i.f. transformers. (See text.)
- $T_3$ —National 500-kc. beat oscillator assembly.
- $T_4$ —Universal push-pull output transformer (Kenyon).
- RFC—2 $\frac{1}{2}$ -mh. sectional choke (National No. 100).
- RFC<sub>1</sub>—10-mh. single-section universal wound r.f. choke.
- RFC<sub>2</sub>—60-mh. single-section universal wound r.f. choke.
- SW<sub>1</sub> and SW<sub>2</sub>—Single-pole panel switches.

connections should be reversed at the coil terminals. If oscillation should fail with the tickler connected either way, the number of tickler turns should be increased a few at a time until oscillation is obtainable.

For  $T_2$  the connection out of the top of the shield is removed and brought down inside to the detector grid condenser and leak which are placed within the can. Plate and grid leads from  $T_2$  also should be shielded with flexible copper braid.

In the beat oscillator unit the grid condenser and leak are also mounted within the can. The only other operation required is to shield the grid lead from the top of the can to the oscillator tube.

#### HIGH-FREQUENCY CIRCUITS

The high-frequency oscillator coupling condenser  $C_1$  is made of two brass angles, having faces about  $\frac{3}{4}$  by  $\frac{3}{8}$  inch, mounted on a small

#### HIGH-FREQUENCY COIL DATA

Band Kc.	$L_1$ Turns	$L_2$ Turns	$L_3, L_4$ and $L_5$ Turns	Tap on $L_5$ —Turns from Ground End
1,750	10	30	55, No. 28 d.c.c. <sup>1</sup>	18
3,500	6	20	28, No. 20 d.c.c. <sup>1</sup>	9
7,000	5	9	11, No. 18 enam. <sup>2</sup>	3
14,000	5	5	5, No. 18 enam. <sup>2</sup>	2

<sup>1</sup> Close-wound.

<sup>2</sup> Spaced to make coil length  $1\frac{1}{4}$  inches.

$L_1$  and  $L_2$  all close-wound with No. 36 d.s.c., spaced  $\frac{1}{8}$ -inch from  $L_3$  or  $L_4$ . Forms are National R-39, five-prong. See Fig. 2 for pin connections.

piece of bakelite in the detector compartment with the faces spaced  $\frac{1}{8}$  inch. The connection from the plate of the h.f. oscillator to  $C_1$  is in shielded braid but may be left unshielded.

The coils are wound on National 5-prong forms according to specifications given in the table. Although 4-prong forms would answer the circuit requirements, by using 5 prongs and the arrangement given in Fig. 2, no damage can result should the coils be placed in the wrong sockets. No attempt has been made to make the tuned circuits track exactly. The over-all gain of the receiver is high enough so that, by judicious use of the gain control, c.w. reception is possible throughout an entire amateur band without touching the tank condensers. For 'phone reception, particularly on 160 meters, a little better tracking would be desirable as it is often necessary to readjust  $C_1$  and  $C_4$  slightly in going from one end of the band to the other. Better tracking can be secured easily by removing a few turns of wire from the oscil-

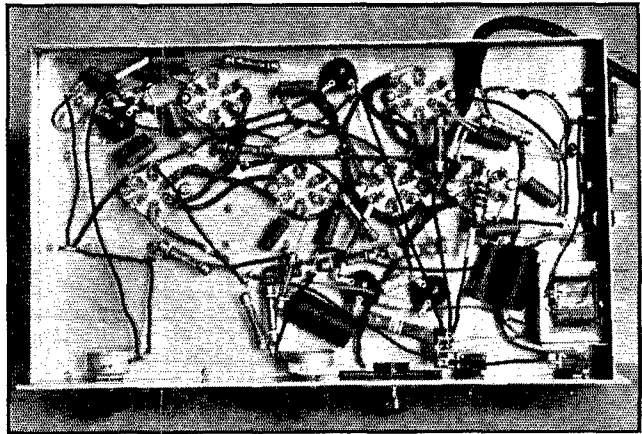

ARRANGEMENT OF THE COMPONENTS BENEATH THE BASE IN W1EAO'S UP-TO-DATE VERSION

lator coils  $L_5$ . A further refinement would be to gang an additional condenser, similar to  $C_2$  and  $C_3$ , for the r.f. amplifier.

All of the wiring except the high-frequency tuned circuits is below the base and needs little comment. Resistors and by-pass condensers are self-supporting and in general are mounted directly to the socket terminals. Shield braid is used on "hot" r.f. connections as indicated in Fig. 1 and all braids are bonded to the chassis by soldered connections. As on the grid caps, short lengths of rubber tubing keep the braid ends from causing grounds at terminals. R.f. chokes are mounted to the base by screws through their wooden cores. All "ground" points are interconnected by a soldered wire.

The power supply leads are brought in through a flexible cable in the rear. The B+ voltage is conveniently distributed from a terminal strip attached to  $SW_2$ . Although only four wires are essential to the power supply cable, cables with four wires having two which are of suitably low resistance for heater currents are not readily available. Accordingly, a standard 8-wire cable is used with three wires in parallel for each of the

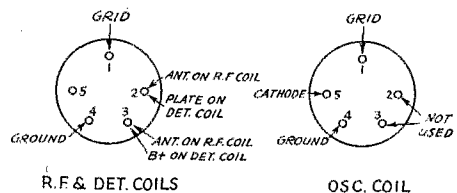

FIG. 2—HIGH-FREQUENCY COIL-SOCKET CONNECTIONS AS VIEWED FROM ABOVE

heater leads. By this means the filament voltage drop from power supply to set is kept to a value of less than 0.1 volt. Care must be taken, however, that all the paralleled wires are securely

soldered to the terminal plug at the supply end of the cable. After the receiver has been in operation for some time, and the plug removed from the power supply, the terminals should not be in the least warm. Any heating here indicates a poor connection requiring further attention.

The power supply is conventional and of the type described in the *Handbook*. The filament winding of 2.5 volts should be capable of delivering the 8 amperes necessary for the tubes and dial light. High voltage under 50-ma. load should be approximately 180 volts. Note that the heater center tap resistor is preferably located in the power supply and connected to the negative "B" lead.

#### METHOD OF ADJUSTMENT

For details of aligning the receiver the reader is referred to the *QST* descriptions of the Single-Signal superhets and to Chapter Five of the current *Handbook*. Briefly, with the selectivity control at minimum selectivity, a 500-kc. signal is applied to the grid of the i.f. amplifier. The second i.f. transformer is then adjusted to resonance as indicated by maximum second-detector output, an insulated socket wrench being used to tune the condensers  $C_6$  at the top of the can. The oscillator is then coupled to the first detector grid and the same procedure is used to tune the first i.f. transformer. The beat oscillator may be isolated from the second-detector circuit and used as a signal source, but preferably a separate test oscillator should be used. If one happens to have a tri-tet or electron-coupled oscillator in the transmitter, a coil can readily be placed in the circuit to give a 500-kc. signal, and adjusted to this frequency by beating a harmonic with the station monitor or frequency meter—as was done in this instance.

If a modulated signal is used, the output can be judged by ear. For an unmodulated signal a 0-50 milliammeter should be placed in the plate circuit of the second detector, when resonance will be

indicated by plate current dip to minimum.

After aligning the i.f., the high-frequency circuits are aligned using the oscillator of the transmitter or a frequency meter giving a signal in an amateur band. The three condensers  $C_1$ ,  $C_2$  and  $C_3$  will have nearly the same settings, although the oscillator (being tuned 500 kc. higher than the detector) will have a somewhat lower capacity setting.

When everything is aligned the c.w. beat oscillator should be set so as to give about a 1000-cycle tone when heterodyning a signal tuned in "on the nose." Now the selectivity control should be brought up to just below oscillation, as indicated by the "ringing" sound. The signal will increase in intensity and, with tuning through zero beat, the audio image or "other side of zero beat" should be hardly audible. Careful manipulation of the alignment adjustments will bring out this desired single-signal feature to its fullest.

The value of the tickler  $L_8$  has intentionally been left so that oscillation in the i.f. circuits can occur with the control resistor  $R_2$  almost, but not quite, at its point of highest resistance. It was reasoned that if oscillation could actually be made to take place there, it would be easier to adjust for maximum regeneration. Of course the receiver never should be operated with the i.f. self-oscillating.

In the first tests of the receiver, a 57 tube was used as a beat oscillator instead of a 58. The former tube, however, persisted in a parasitic oscillation of about 8000 cycles which gave rise to a whole family of beat notes for each incoming signal. Since they were not present when using a 58, the latter tube was substituted and found very satisfactory.

The National oscillator unit,  $T_3$ , is designed for a Type 24 tube and has a large tickler. With a screen dropping resistor,  $R_{15}$ , of 1000 ohms, but with other values as shown in Fig. 1, a screen voltage of 35 volts and a plate voltage of 85 volts

(Continued on page 100)



QRM and CQ Hounds, as shown in *QST* in 1923—and as we still know them!

# High-Q Tank Circuits for Ultra-High Frequencies\*

An Intriguing Arrangement for 56-mc. Oscillators

By Frederick A. Kolster\*\*

Dr. Kolster's name is familiar to most of us in connection with his decremeter, the standard wavemeter of its day, and his direction-finding equipment. Not so well known to us are his more recent developments in the ultra-high frequency field, in which he has been engaged both in California and in the East. One of these developments is a new type of high-Q tank circuit, especially applicable to 56-mc. transmitters, which it is our good fortune to present in this article.—EDITOR

THE electrical efficiency of a resonant circuit is completely defined by its  $Q$  value. This depends upon the constants of the circuit and may be expressed by the formula

$$Q = \sqrt{\frac{L}{R^2C}}$$

In practice it is difficult to construct an ordinary coil and condenser circuit for very high frequencies, 60 mc., for example, which will have a  $Q$  value much greater than, perhaps, 300.

Since for very high frequencies the required values of  $L$  and  $C$  are relatively small, we may depart from the usual coil and condenser construction and thus obtain much higher values of  $Q$ .

A highly efficient high-frequency circuit may be constructed as shown in Figs. 1A and 1B. The complete tank circuit is formed by mounting two copper shells upon a copper tube. The spaced flanges or rings provide the capacitance of the circuit; and the copper tube, together with the concentrically disposed shells, forms the inductance.

Design data for circuits constructed as in Fig. 1A, suitable for a frequency of approximately 60 mc., are tabulated below for tube sizes ranging from 3 inches to 1 inch in diameter. In each case the effective tube length,  $l$ , is  $8\frac{1}{4}$  inches and the

required spacing between flanges,  $S$ , is  $\frac{1}{4}$  inch.

Tube Diameter	$D_1$	$D_0$	$Q$
3 inches	15 in.	$19\frac{1}{4}$ in.	3000 (approx.)
2 "	10 "	$15\frac{3}{4}$ "	2000 "
$1\frac{1}{2}$ "	$7\frac{1}{2}$ "	$14\frac{1}{4}$ "	1500 "
$1\frac{1}{4}$ "	$6\frac{1}{4}$ "	$13\frac{1}{2}$ "	1250 "
1 "	5 "	13 "	1000 "

For the construction shown in Fig. 1B, wherein the capacitance is formed by two rings centrally located on the copper shells, the following tabulated design data are given for cases where large tube diameters are used. (See table below.)

The actual tank circuit shown in the photograph is typical in general appearance of one constructed in accordance with the design data given in connection with Fig. 1A for a tube diameter of  $1\frac{1}{4}$  inches. This is provided with means for varying the separation between flanges by movement of one of the shells along the tube. In this way the circuit may readily

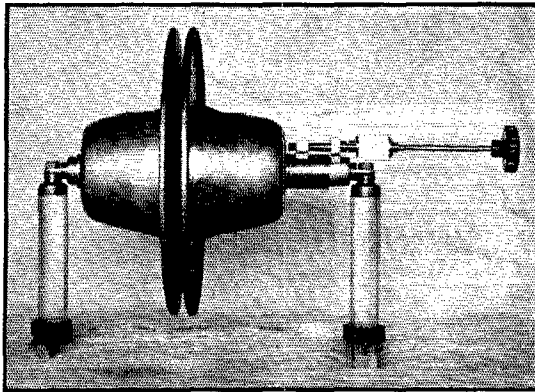

RESEMBLING A PAIR OF DERBY HATS, THE NEW TANK CIRCUIT IS A FAR CRY FROM OUR CONVENTIONAL ARRANGEMENTS

be tuned to any desired frequency within the band assigned for amateur use.

A method of connecting a vacuum tube to the tank circuit for the generation of high-frequency

Tube Diameter	$r$	$a$	$Q$
3 inches	$7\frac{1}{2}$ in.	$2\frac{1}{2}$ in.	3000 (approx.)
2 "	5 "	$3\frac{3}{4}$ "	2000 "
$1\frac{3}{4}$ "	$4\frac{3}{8}$ "	$4\frac{1}{4}$ "	1750 "
$1\frac{1}{2}$ "	$3\frac{3}{4}$ "	$4\frac{7}{8}$ "	1500 "

\* From a paper presented by the author before the New York Section of the I.R.E., March 7, 1934.

\*\* International Communications, Inc., 67 Broad St., New York City.

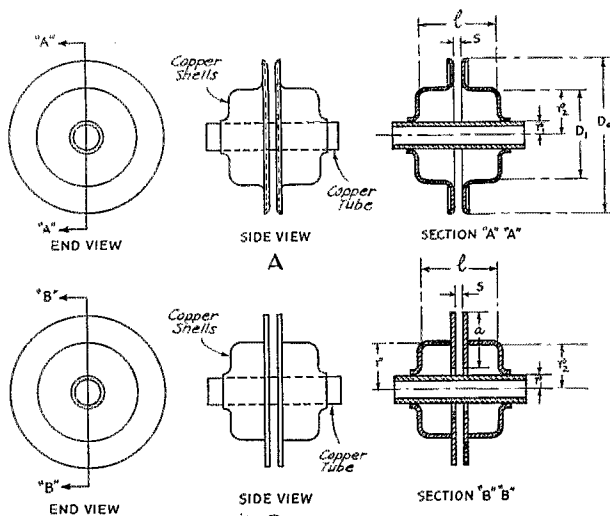

FIG. 1

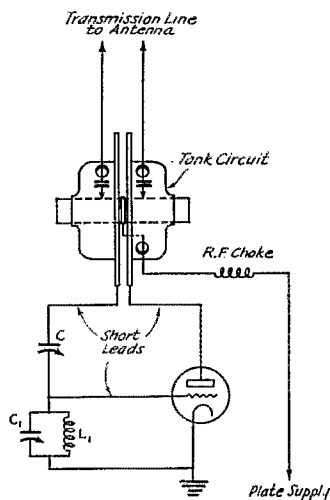

FIG. 2

oscillations is shown in Fig. 2. The plate of the vacuum tube is connected directly to one of the flanges of the tank and the grid is connected to the opposing flange through a variable condenser,  $C$ , whose maximum capacity need not be more than 25  $\mu\text{fd}$ . It is necessary that short leads be used for these connections. Between the grid and filament a tunable circuit  $L_1C_1$  is connected. This circuit serves merely as a variable impedance which establishes the oscillatory condition of the circuit; and its frequency, as determined by the value of  $C_1$  and  $L_1$ , is always lower than the generated frequency. The maximum value of  $C_1$  may be about 50  $\mu\text{fd}$ , and a value of  $L_1$  chosen such that the circuit  $L_1C_1$  will tune well below 60 mc.

A few experimental trials will determine the required value of  $L_1$  and  $C_1$  for best operation. Adjustment of grid excitation is provided by the variable condenser  $C$ . Since the plate voltage is connected to the center of the tank circuit, it is advisable, as a matter of protection, to place blocking condensers in series with the transmission line which feeds the antenna as indicated in the diagram of Fig. 2.

Because of the fly-wheel action of the high- $Q$  tank circuit connected as in Fig. 2, and designed as specified, a high degree of frequency stabilization may be obtained; provided, of course, that the tank is operated at a temperature sufficiently uniform to insure permanency of its physical dimensions.

## Hamdom

(Continued from page 58)

East Coast on spark. The best two-way contact was with 5XU in Texas; they were able to hear 9ZN in Chicago, however. They received the first transcontinental relay message from Hiram Percy Maxim and sent back the record-making reply. After the war they added the call 6EB, Howard Seefred retaining 6EA, and installed tube transmitters with which they have worked the world. The joint station was dismantled in 1931, when Lyndon married; Howard has since followed his example. Both still follow the DX trail, although the snarling rotary has given way to the glowing tube and the wave has changed from 200 meters to 20.

A. H. KEITH RUSSELL is another of the 1909 vintage, and exemplary of the fact that from the very first the A.R.R.L. included

Canada as well as the United States. He had the usual group of early detectors, transformers, and the like, ending up with one of the first deForest audion detectors and a Clapp-Eastham rotary quenched gap. In 1915, freshly graduated from the University of Toronto, he joined the Canadian Naval Service, changing to the Royal Naval Air Service in 1917 and seeing action in France and Italy. In 1920 he emerged as a graduate barrister, and resumed his amateur career under the calls 3AL and 9AL. He became, first, SCM for Ontario, and then Canadian General Manager of the League. In addition to his radio activities, he has been active in the development of Canadian Flying Clubs, and has served as an official in several of these groups. He holds both a first class commercial radio operator's license and a private pilot's license. His law firm in Toronto is Lester and Russell. He still retains the call VE9AL, and his interest in amateur radio is as great as it was twenty-five years ago.



# A New Pentode-Type Screen-Grid Transmitting Tube

A Design for Suppressor-Grid Modulation With 50-Watt Peak Output, Small Grid-Plate Capacity and Large Power Amplification

By James J. Lamb, Technical Editor

*QST's plea to the tube manufacturers for a screen-grid pentode in the intermediate 50-watt range has not gone unheeded. Already we are able to present the preliminary details of the first of the new types—a tube which has provided a performance far beyond our expectations.*

*The screen-grid pentode transmitting tube is, we believe, destined to play a very important part in amateur radio of the future.—EDITOR*

**T**HE first of what undoubtedly will develop into a series of pentode-type r.f. power tubes, forecast in our article on suppressor-grid modulation in March *QST*, has already arrived. Preliminary experimental models have reached us for test and trial, and a snapshot, just in time to get the first information into this issue. Which is altogether fitting, since, coinciding with A.R.R.L.'s 20th anniversary celebration, the new tube by Raytheon bears the type designation RK-20. Without waxing unduly enthusiastic, we can say that the new type screen-grid tube more than meets expectations, not only in its special rôle of suppressor-grid-modulated r.f. amplifier, but also as a general-purpose r.f. amplifier of large power gain and as a tri-tet crystal-controlled oscillator of real power output. But let's give its general description before sketching its applications.

As is evident from the illustration, in external appearance the RK-20 resembles its predecessor in the 50-watt class, the RK-18, with the exception that it has an envelope of slightly greater girth and a five-pin base to accommodate the additional grid element. Filament, control-grid, screen-grid and suppressor connections are brought out to the base; the plate terminal exclusively occupies the opposite end. This separation of the plate lead from the control-grid connection, combined with the tube's exceptionally small internal grid-plate capacity, gives especially effective isolation of input and output circuits,

thoroughly minimizing possibility of feed-back coupling.

Preliminary ratings assigned to the RK-20 are as follows:

Filament voltage ( $E_f$ )	7.5 volts
Filament current ( $I_f$ )	3.0 amps.
Normal plate voltage ( $E_b$ )	1000 volts
Safe plate dissipation	40 watts
Normal screen-grid voltage ( $E_d$ )	300 volts
Safe screen dissipation	10 watts
Normal suppressor voltage ( $E_c$ )	0 volts

Typical operation as an oscillator or r.f. power amplifier:

$E_b = 1000$  volts,  $E_c = -75$  volts,  $E_d = 300$  volts,  $E_c = 0$ .

(Suppressor connected to filament; control-grid bias,  $E_c$ , obtained by 15,000-ohm leak)

Plate current ( $I_p$ )	85 ma.
Screen current ( $I_d$ )	30 ma.
D.c. control-grid current ( $I_c$ )	4 to 6 ma.
D.c. suppressor-grid current ( $I_e$ )	0.25 ma.
Power output	50 watts

The inter-electrode capacity figures are particularly interesting. Here they are:

Input capacity (grid-filament)	11.0 $\mu\text{fd}$ .
Output capacity (plate-filament)	9.5 $\mu\text{fd}$ .
Grid-plate capacity without external shield	0.01 $\mu\text{fd}$ .
Grid-plate capacity with external shield	0.003 $\mu\text{fd}$ .

The tube shield idea is something of an innovation for screen-grid power tubes, although familiar enough in connection with receiving tubes. With the RK-20, this shield should enclose the base and the lower third of the envelope, reaching up only to the lower end-shield disc that is part of the internal structure. The shield should not touch the glass, however. As indicated by the figures for

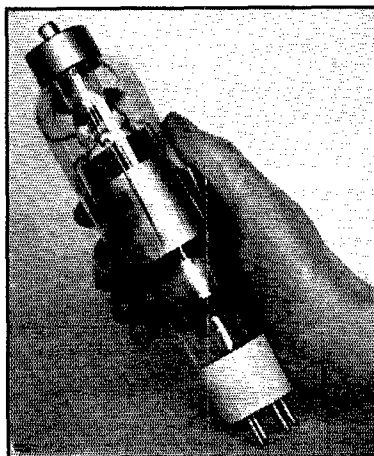

THE NEW TUBE

grid-plate capacity, this shield brings the already extremely low capacity of 0.01  $\mu\text{fd}$ . down to less than a third of that value—to less than the figure for a receiving type screen-grid tube, in fact. And that, in itself, is something.

#### OPERATING CHARACTERISTICS

Although data on the averaged characteristics are not yet available in complete form, operating characteristics obtained in several night sessions with experimental samples provide the basis for some interesting conclusions. The first of these is that the tube shows, to a remarkable degree, the high power sensitivity or power amplification that would be expected of a pentode; that is, it requires relatively small r.f. excitation power for full output at high plate efficiency. At 14 mc., for instance, the normal output of a Type 59 operating as a frequency doubler with only 300 volts on its plate has been found to give excessive excitation. Actually, it was necessary to reduce the grid driving power, by knocking down the exciter's output, to the point where a small neon tube would hardly glow at the power amplifier's grid, optimum excitation occurring with the exceptionally small rectified grid current of approximately 5 ma. through a leak of 15,000 ohms (average negative bias voltage, 75 volts). The drop in output with higher excitation indicates, of course, the "double-humped" plate output current characteristic (described by Robinson on page 28 of February *QST*) resulting from excessive excitation. This is an unusual occurrence with the excitation ordinarily available. Although measurements of the r.f. driving power could not be made, it is conservatively estimated that not much more than 1 watt excitation was required for a measured power output of 50 watts—showing a power amplification ratio of approximately 50, even at 20 meters. From this it is likely that one of the tri-tet exciter units described in October and November, 1933, *QST* (and in the *Handbook*) would prove adequate to drive a pair of the new tubes in parallel in a straight amplifier at 14 mc.—with 100-watt output. The exciter used in this test, it should be mentioned, was the one described in the November issue and in the *Handbook*, with the new tube substituted for the RK-18 in the companion unit described in December *QST* and in the *Handbook*. There was not time to get diagrams of circuit details ready for the present story—but we'll have them next month.

#### SUPPRESSOR-GRID VARIATIONS—MODULATION

Once acquainted with the general behavior of the tube under "normal" circuit conditions, no time was lost in getting busy with the suppressor circuit. Variation of the suppressor voltage over a range either side of zero bias showed that the r.f. output current *vs.* suppressor bias was beautifully linear over the range between 45 volts positive and slightly more than 90 volts negative. This promised somewhat higher peak power output than was obtained with the normal zero suppressor voltage—and measurement showed this to be so. Here are the results summarized, with actual figures that were found to be safely satisfactory:

Plate voltage	1100 volts
Screen voltage (Mean)	400 volts
(Obtained from voltage divider across plate supply)	
Control-grid bias (15,000-ohm leak)	- 75 volts
Suppressor voltage	- 100 to +45 volts
Plate current	5 to 100 ma.
Screen current (Mean)	28 ma.
Control-grid current (d.c.)	5 ma.
Suppressor current (0 to +45 volts)	0.25 to 4 ma.
R.f. load current (through 55 ohms)	0 to 1.1 amp.
Peak power output	66 watts

For 100% modulated operation:

Suppressor bias	- 28.5 volts
(22½-volt and 6-volt "C" batteries in series)	
Plate current	50 ma.
Carrier power output	16.5 watts
Average plate efficiency	30 %
Peak plate efficiency	60 %
Minimum suppressor resistance	10,000 ohms (approx.)
Max. suppressor power required *	0.2 watt (approx.)
Peak audio voltage for 100% mod.	72.5 volts

The r.f. amplifier circuit for modulation is the same as for the Type 59 stage of Don Mix's set described in this issue, except that no neutralizing is necessary. A Type 45 was used as a modulator and the modulator coupling transformer was a standard Class-B input type of 1-to-1 total primary-to-secondary ratio connected to give 2-to-1 step-down to the suppressor circuit, with a 5000-ohm stabilizing resistor across the secondary. The suppressor draws no power below a few volts negative, of course; and the negative resistance peculiarity previously mentioned in connection with the 59's does not seem to be present.

Next came tests in a tri-tet crystal oscillator circuit, including modulation of this as a single-stage 'phone transmitter. But here's Ross Hull calling for final copy—no time for more of the outline at the moment. The June issue will have the complete story, with all the circuits and details.



# THE COMMUNICATIONS DEPARTMENT



F. E. Handy, Communications Manager  
E. L. Battey, Assistant Communications Manager

FLASH! A.R.R.L.'s "20th Anniversary Relay" (April 7-8, 1934) was the greatest relay of its kind ever held! President Maxim received even more messages from members in every section of the country (not to mention 10 foreign countries) than on the occasion of his most successful 60th birthday relay in 1929. Among the hundreds of messages of congratulation and best wishes to your League and its President were many good and constructive suggestions. Mr. Maxim thanks all members, and the scores of clubs and other organizations sending messages, for their expressions of good will, and for the splendid interest evidenced on this occasion. He appreciates your past loyalty and your pledges of support in building for the future.

Connecticut had the largest organization of stations ever to work in the common purpose of delivering messages to one point in an A.R.R.L. relay project. Their full measure of cooperation and consistent effort merits the highest praise! Messages numbering in the hundreds were handled by the following stations in the order of the magnitude of their work: W1CJD, W1AMG, W1BSS, W1B1C\*, W1AFB, W1AKI, W1EDI\*-W1DSV\*-W1BMP, W1HPI, W1KV, W1GC-W1DGG-W1HYB, W1BHM-W1CEG-W1GME, W1FXQ-W1CTI-W1HTS, W1FIO, W1VB-W1SZ-W1QV-W1NE, W1HNF-W1FUW-W1DBP(W1YU)-W1DMP, W1FMY-W1DF-W1GTO - W1BWM - W1AGT - W1ANA - W1GVV - W1GKM-W1UE-W1BDI, W1CDZ-W1HSU-W1DOW-W1NI, W1BNR\*-W1BDE-W1EAO-W1GGM-W1GUC-W1HWT, W1HAX-W1GUN-W1FOP-W1DBU-W1EH-W1ES, W1GXU\*-W1HIR-W1EBT. Three operators kept W1MK on the air continuously, and 36% of all messages received by Mr. Maxim were received at W1MK.

W8GUF did especially noteworthy work, of those stations outside Connecticut, handling 226 different messages in the short time of the relay! W8GUF, W1VS and W1CRA have received letters of commendation from President Maxim on their relaying, which was outstanding, as have also W1CJD, W1AMG and W1BSS. Among ingeniously worded messages, the first letter of each sentence of the one from W8LAL spelled CONGRATS MR MAXIM. W5BHP got poetical, his message, "Roses are red, violets are blue; Three cheers for the League. Our hat's off to you."

Dozens of messages were received from real old-timers. Among these, for example, meet: Harold Mapes (member 1916), first Mexican ham active at BX, now W7DXV; Dr. C. F. Muckenhoupt, W1HUG, lic. 1915 as 2HY, and rec'd first copy of QST; Guy E. Wilson, W9EL, mem. 20 yrs.; J. F. McMahon, Jr., W1NE, remembers founding; C.R.T.A., Chicago, 11 years affiliated; James E. Hausser, 8LB '18; Larry Dunham, W8EIK, ex-3ZY;

\* Indicates 'phone operation.

Ray Burns, W2BCX, used to work HPM years ago as tel. opr.; Jackson, W1BSS-W1HB 1909; R. W. Woodward, W1EAO, ex-SNS, ex-1VW (original member, present in R. C. of H. at founding A.R.R.L., used same key in '14 sending his message to A. A. Hebert, also original member, to be delivered on one of original A.R.R.L. blanks!); "Daddy" C. J. Dawes, VE2BB; G. S. Wickizer, '19 W2DOG, ex-8BIL; McKelvey, W5AQ, ex-8AU; T. J. Rigby, W7COH '06, now A.A.R.L.-RM; E. B. Judson, W3AFU (rec'd first copy QST); R. E. Lichty, W3BLF, ex-3BG; H. C. Bird, W8DPE, ex-800.

## Meetings Scheduled

Atlantic Division Convention, Pittsburgh, Pa., June 22nd-23rd.

May meeting of Hudson Division, College of Engineering, Rutgers University, New Brunswick, N. J., May 4th, 8:15 p.m., auspices of The Associated New Jersey Amateur Radio Clubs.

Saskatchewan Hamfest, Moose Jaw, Sask., Canada, May 24th, auspices of Moose Jaw Amateur Radio Club.

## RE SCHEDULES

The average traffic handler, and fellow who keeps regular schedules, loses sight of the fact that he not only is running up a nice total for his station, but is also contributing a real, and not a fancied service to his country.

The man who keeps a regular schedule, regardless of the amount of traffic handled (even if any particular schedule doesn't record a single message in a month's time), is contributing a service to his community that can't begin to be measured in dollars and cents.

First, by keeping daily schedules with regular attendance, he creates confidence in his dependability. His schedules stations respect him, and look forward to each contact. Second, by virtue of this confidence he has chances to get off messages, personal or otherwise, with almost 100% regularity. At the same time he has established an outlet for any emergency that might occur locally; in the event that all other means of communication fail; and we all know how often this happens.

Third, coupled with the above, even if the emergency is not local, he is well equipped to assist in distant emergency work through the distributing facilities he has at his command.

Fourth, getting back to the personal end of the thing, by continual keeping of schedules, he betters his operating, and sending, just by the regularity of work, and at the same time is wholly free of anything that takes away from keeping radio a hobby, and makes it a job, which it should never be as long as it is kept in its amateur status.

Isn't this sufficient evidence, that when we keep regular schedules, regardless of the nature of said schedule, we are contributing a real unselfish, patriotic service, to our community, and eventually to our nation?

--W1BOF

## Tenth Anniversary Greetings

The occasion of the tenth anniversary of two-way amateur radio communication between Great Britain and the United States was commemorated on December 8, 1933 by an exchange of greetings between President Swift, G2TI of R.S.G.B. and President Maxim, W1AW of A.R.R.L. The message from G2TI reached W1AW via G6CW, G5NF, VPU2 (Sierra Leone, West Africa), and W2ADQ, who mailed to Hartford. The message from W1AW was transmitted on regular W1MK Dec. 7 and 8 "QST" schedules with the request that amateurs receiving it forward it to G2TI. The texts of both messages are quoted:

To The President, A.R.R.L.:—On this historical anniversary of the first Anglo-American contact on high frequencies made by Warner and Partridge I extend to you and your League fraternal greetings on behalf of all members of my society. I trust that the cordial relationship which have at all times existed between our organizations will long continue.

(Signed) *Bevan Swift, G2TI*  
President, R.S.G.B., London.

To The President, R.S.G.B.:—Please accept felicitations on the tenth anniversary of the establishment of two-way amateur radio communication between Great Britain and the United States. As we expected at the time it marked the beginning of a new era in radio communication.

(Signed) *Hiram Percy Maxim, W1AW*  
President, A.R.R.L.

G2ZQ and G5YH also sent a message of greeting to President Maxim via W1LZ. This message read, "Younger generation of British amateurs send greetings on the tenth anniversary of first contact between England and U.S.A. (signed) Chorley G5YH and Hunter G2ZQ." A reply to this was handled by W1LZ to F8EX and G5SR.

## WCFZ

The Yacht "Buccaneer," WCFZ, sailed from New Orleans, January 1st, for a seven months' cruise of the south Atlantic with a party of 18. WCFZ will work as many amateurs as possible, and will be on 8290 kcs. each night looking for 7-mc. band amateurs.

The photograph shown was taken at Vera Cruz, Mexico. Mr. A. D. Mayo, Jr., W4CBD, is operator of WCFZ. He writes as follows: "Quite a few amateurs have been worked, and on one occasion an emergency message was given to W5DNP, who put it on a land line. Fine friendships have been formed at Tampico and Vera Cruz with X1BL, X1BR and X1BH, which will be continued by amateur radio when I return to the States. Most Mexican operators speak good English. Their equipment is largely imported from the U.S.A., but is relatively cheap in dollars, as the Mexican government does not charge an import duty."

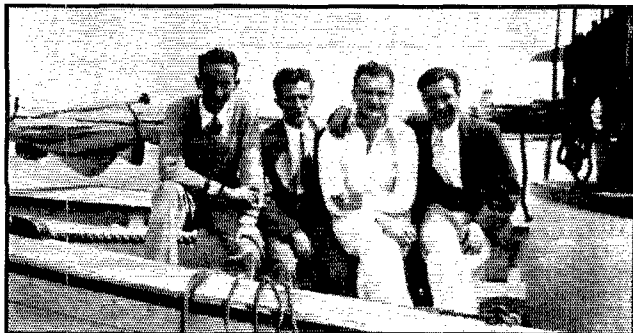

X1BN, X1BR, W4CBD, AND X1BL SITTING ON THE ANCHOR WINDLASS OF THE YACHT "BUCCANEER"

Temperature 100° F. in February.

## License Exams

Examinations for radio operator licenses will be held on May 4th and 5th in the Civil Service Room, P. O. Bldg., Winston-Salem, N. C. Two sessions will be held each day at 9 a.m. and 1 p.m. One class of amateur examination can be taken at any session. Applicants desiring examination for both Class "A" and Class "B" licenses must appear not later than the 9 a.m. session on May 5th. Applicants for commercial examinations must appear not later than the 1 p.m. session on May 4th.

A monkey sat on a circus pole  
His antics made a hit  
He scratched his head  
Caught one and said  
Dit Dit Dit Dit Dit Dit

—T.C.R.C.'s Haywire

The following contribution by Mr. S. B. Trainer, Jr., VE3GT wins the C.D. article contest prize for this month. Your articles on any phase of amateur communication activity are likewise solicited and may win you a bound Handbook or three logs, or equivalent credit applied toward other A.R.R.L. supplies. Let us have your article, and mark it "for the C.D. Contest," please.—F. E. H.

## On Getting Results in Ham Radio

By S. B. Trainer, Jr., VE3GT\*

THIS amateur radio is a great hobby—a great plaything for an idle hour. Some of us are fortunate enough to be able to devote several hours a day to it, but the majority can only afford the odd hour, now and then. But, *do we make the best of this hour?* Very few really do. Often we wonder if it hasn't been an hour wasted. Perhaps a half dozen CQs, and a few stations have been called, and nothing worked, and, with periods of listening in between, the hour is gone, we turn off the switches—not at all satisfied.

Generally speaking, this is our own fault. Most of us have low power, anything from '01A with "B" supply to "tens" in push-pull. Backyards are small and antenna size limited. 7- and 14-mc. operation may seem best—technically. If signals are weak on 7 mc. due to skip effects, why not try 3.5 mc.? Use the 7-mc. antenna, "loaded" or with ground, or as may be necessary for all-band operation. You'll then have QSOs and can go to the band where operating is most reliable. It takes only five minutes' listening on each band to learn the general conditions. Then select a band that seems alive . . . where chances of QSO without excessive calling are good, and you'll accomplish something in your spare time.

If you are primarily interested in DX, study DX conditions. You'll soon learn when DX comes in best. Don't send "CQ DX," long and lustily! Most DX on this continent is worked by calling DX stations heard, not by calling "CQ DX." If you can't hear any DX, don't waste time trying to raise some. It won't be there.

### ARRANGE SKEDS

Do you use that fifteen minutes before supper, or before breakfast? Or do you find there is not enough time for a good QSO? Why not arrange a sked with some one you happen to QSO at that time? You'll then know where to locate each other on the band. A short call on schedule, each night, brings your friend back at you. You can then rag-chew, or handle any mes-

\* SCM Ontario, 4 Shorncliffe Ave., Toronto 5, Ont., Canada.

sage that might come along. You can easily arrange a schedule west before breakfast and one east before supper. If the stations you schedule do the same, before you realize it you have established a cross-continent route or connected with some Trunk Line. You then have a schedule than can be employed in times of floods, earthquakes, storms, etc. You justify your existence to the world at large by your readiness to be of service. You increase your own pleasure, and success in amateur radio, too. This is *one* way to accomplish a hundred times as much in your spare time as haphazardly hoping to get a QSO when conditions are poor.

For those who see the benefits of such a policy, the worries of QRM are lessened. Families become more appreciative of amateur operators and ham radio. Low power gets out surprisingly well and far, under such conditions. By "planned" amateur radio you can justify your hobby and operating work as many do not.

Let your SCM know what you are doing each month. Report who you "sked," your latest DX, new equipment, your traffic, even if it's one lone message. Help your SCM build up your section. What your SCM accomplishes depends on you. So, back him and boost him. But, above all, when you can be on the air, accomplish something. You can. It satisfies.

### Traffic Briefs

After 20 years of hamming W1ZS-II-BZI gets wife *by radio!* Taking advantage of the fact that Miss Grace Cragin had just learned the code, OM Huddy, W1ZS, used radio for the proposal—it was the first complete message she had ever received! That's what we call starting them in *right*.

W9OX, Kentucky SCM, is one of the real old-timers. He recently sent in a photo of his station as it looked in 1920—rotary spark gap, 1 kw. transformer, 200 meter helix, castor oil condenser and all! He also has an early letter from President Maxim which acknowledges a report on reception of W1AW's signals at W9OX. Mr. Maxim said he would be on the lookout for 90X's signals—to-day W9OX has a regular schedule with W1MK!

### MORE ON I.T.K.—NOW CHANGING NAME TO "THE INTERNATIONAL RADIO FRATERNITY"

Since sending Mr. Isbell of I.T.K. affiliation papers (which he requested), Mr. Melan writes us further, stating his societies reversal of its formerly expressed attitude toward your A.R.R.L. We are glad to quote from his letter at his request, since this speaks for itself. As we are limited by space here, we suggest that anyone interested in an expansion of the I.T.K. views may write A.R.R.L. for a more detailed copy of this letter.

... the statement in *QST* that we desire affiliation is greatly damaging to us, and is humiliating. . . . I.T.K. members may think their leaders are selling out to A.R.R.L. We ask that you make public this statement that we do not want affiliation with the A.R.R.L. or any other society.

—THE I.T.K. RADIO FRATERNITY  
 Jos. Richard Melan, W6CGM  
 The Hi-Klowatt!

The statement in *QST* referred to appears on page 63, March 1934 *QST*. We thought it would help I.T.K. At the time written we did not know the "new" I.T.K. charged \$1.00 for I.T.K. membership. Several O.R.S. have written asking us if the League endorses I.T.K., and if there are benefits worth the \$1.00. We cannot answer the latter part. However, it must be said that the League cannot endorse I.T.K., and that it must not permit a false impression to get about that A.R.R.L. is the sponsor or is behind I.T.K. Contrary to an impression among some amateurs, I Tappa Kee, whose publicity is sponsored by *Radio*, a west coast magazine, is not an A.R.R.L. affiliated society, and is in no way connected with A.R.R.L. It is understood that I.T.K. will now call itself *The International Radio Fraternity*, operating with the same policies and under the same sponsorship.

### BRASS POUNDERS' LEAGUE

(February 16th-March 15th)

Call	Orig.	Del.	Rel.	Total
W8GZ	104	128	2322	2554
W2DIU	159	277	1846	2282
W6ZG	1171	212	591	1974
W8JE	37	52	1487	1556
W8ETL	106	242	1116	1464
W9EG	43	167	1184	1399
W9MZD	104	84	1177	1365
W9ESA	16	64	1142	1222
W2BCX	141	137	860	1138
W2EKM	112	73	890	1075
W6BMC	17	28	1010	1055
W8GXM	83	176	748	1007
W5CEZ	112	80	718	910
W6ALU	81	331	488	900
W3BWT	106	184	599	889
W3CL	66	322	474	862
W7AYV	135	152	572	859
W9LJY	117	155	545	817
W8CEU	135	72	598	805
W4IR	152	358	288	798
W8GUF	30	45	714	789
W9EVJ	18	80	657	755
W9GJQ	92	71	522	685
W7CZY	25	76	583	684
W6EYR	104	84	474	662
W6DQN	31	45	580	656
W5BML	20	23	596	639
W8EMV	62	79	492	633
W9DFP	112	43	473	627
W3AAV	251	265	94	610
W8TWT	38	34	532	594
W2AYJ	81	53	468	582
W4AFM	54	14	504	572
W9MDL	54	85	426	565
W8CIO	9	22	526	557
W1VB	48	90	418	556
W1AMG	104	103	334	541
W6NF	312	176	62	550
W6CUU	35	84	410	529
W3SB	—	—	527	527
K1EE	40	12	470	522
W9BCK	27	31	462	520
W2DQ	219	178	139	517
W6GQC	88	105	324	517
W8CVS	85	78	353	516
W9ILH	10	29	473	512
W1PIO	67	121	320	508
W9FLG	69	86	346	501

### MORE-THAN-ONE-OPERATOR STATIONS

W3CXL	335	506	1616	2457
W6OW	187	134	1802	2123
K6EWQ	597	300	986	1883
NY1AB	210	194	1152	1556
K1IHR	320	219	904	1443
W8YA	58	62	400	520

These stations "make" the B.P.L. with *totals* of 500 or over. Many "rate" extra credits for one hundred or more deliveries. The following one-operator stations make the B.P.L. for *delivering 100 or more messages*; the number of deliveries is as follows: Deliveries count!

W6GHD, 229	W1CRA, 126	W4CHJ, 108
W4DD, 220	W7AVP, 118	W7BMF, 104
W8ND, 174	W4NC, 115	W2ELK, 101
W6AZU, 148	W9LXO, 114	More-than-one-opr.
W9HUZ, 132	W3DZ, 109	W1MK, 102
W9KQJ, 128	K1ILG, 109	
W8ALE, 126	W5MN, 107	

A total of 500 or more, or just 100 or more *deliveries* will put you in line for a place in the B.P.L. Make more schedules with reliable stations. Take steps to handle the traffic that will qualify you for B.P.L. membership also.

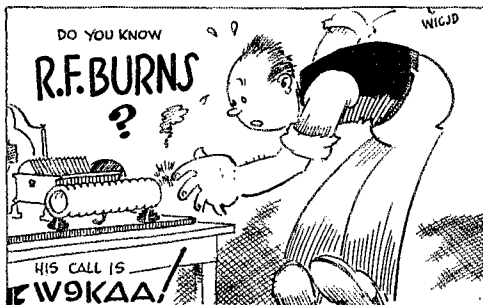

## Emergency Work in North Carolina

From the "Tarheel Ham," monthly publication of Director Caveness, W4DW, we glean the following information on emergency work well done by North Carolina amateurs: On Sunday night, February 25th, and Monday morning, the 26th, Winston-Salem, N. C., was visited by the worst sleet and ice storm in the memory of its oldest inhabitants. Amateur radio QRR work centered around W4NC, the station of the Winston-Salem Amateur Radio Club. The first call for assistance from W4NC was reported by W4OG, who called W4ABT, chief operator at W4NC, to report that the N. & W. Railroad needed communication with Roanoke. From then on the 'phone continued to ring requesting out-of-city communication. Western Union and the telephone company with wires down, Southern R.R. wanted to dispatch trains, S.P.U. Co. wanted to send for extra crews and materials for reconstruction work. W4NC had been incapacitated by the storm and it took considerable time before the members had her perking again; however, the ammeter finally jumped up, and an excited operator sent out the first QRR. Contact was made with W4BLN, Charlotte, who arranged with W4BX to clear W4NC's emergency traffic. Upwards of 100 messages were handled for railroad, telegraph, telephone and power companies, the work going on for almost 40 hours. It was a splendid piece of work and the W4NC crew, W4BLN and W4BX deserve a world of credit. FB!

## Chicago Amateur Radio Council

The following information is taken from "QTC," official organ of the Chicago Radio Traffic Assn.: On February 8th a meeting was held in the Atlantic Hotel, Chicago, for the purpose of making preliminary plans for the establishment of a "Chicago Council" to represent all amateurs in the Chicago Area in matters pertaining to amateur radio. Representatives of the following clubs and organizations were present: The Army Amateur Radio System, Chicago Radio Traffic Assn., Chicago Suburban Radio Assn., Fenger Marconi Club, Hyde Park High School Club, Illinois Ham Club, Morton High Club, Northern Illinois Wireless Assn., Southtown Amateur Radio Assn., Suburban Order of Shortwaves, Tri-Town Radio Amateur Club, U. S. Naval Communication Reserve. W9VS presided at the meeting. An official name has not yet been chosen for the Council. The principal thought in organizing is that "in union there is strength," and that through union better cooperation is made possible. The Council will receive its ideas from the representatives appointed to it (each club will have at least one representative), who in turn will carry these ideas to their clubs for vote, or discussion. The vote of the clubs will be returned to the Council by the representatives, where the majority ruling will hold. More information will be forthcoming when final arrangements are completed.

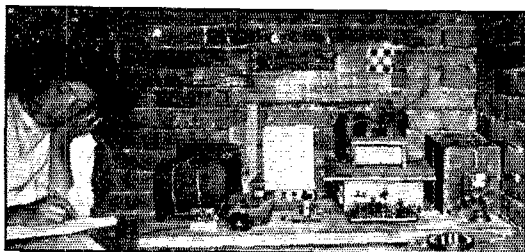

1911 AMATEUR-RADIO

Note the single-slide tuner, 1½ inch spark coil, spark-gap, etc. W6EFP (post war 6UR) had the photo taken to celebrate replacement of his electrolytic detector with an up-to-date crystal detector! Yes, the operator is W6EFP—22 years ago!

W1ATE, Wellesley Hills, Mass., worked all districts on 1.7-mc. 'phone during the period Nov. 1-17, 1933. Other first-district stations to contact all districts on 1.7 mc. are: W1GLX, E. Windsor, Conn.; W1DIK, E. Providence, R. I.; W1FVO, Stamford, Conn., and W1DVX, New Milford, Conn. In five months of operation, Nov. 1, 1933-Mar. 31, 1934, W1ATE, using a pair of '10s in final stage with 50 watts input, has made thirty-six contacts with the west coast on 1.7-mc. 'phone! A total of 41 states! Stations contacted by W1ATE include W6AAA, HOE, IWS, IWY, DHP, DEP, CKR, JWY, HXP, HVP, BPX, W7CIL, CAL, BDC, EAA, DNB, BCE, AYG, DAJ, YZ, VEAGA, 4EU. An impressive list! A real record for the power used. Other amateurs operating 1.7-mc. 'phones are invited to send in notes on their accomplishments, unusual incidents, etc.

Old-timers will have vivid recollections of the famous 6ZAC-9AWM-1AW relay in 1922. It was the first time a message reached the east coast with only one intermediate relay. R. J. Reid, one of the operators at ex-1AKG, sends a copy of the message, which was handled at that station. Notations on the copy show "Msg received at 1AKG by op 'RD' and delivered by op 'HF'. . . . Delivered to 1AW at 3:45 a.m. E.S.T. Nov. 10, 1922. . . . Received at 1AW by op 'FS'. . . ." 1AKG was owned by S. K. Heffernan (HF) and was operated by him and R. J. Reid (RD) at Salem, Mass. Both of these OT's are now at WCKY, and operate a ham rig under the call W9VR. 1AKG was heard across the pond in the first trans-Atlantic.

## Byrd Expedition

Latest dope on KFZ-KJTY-WHEW operation comes to us through Vandekamp and McCutchan, NY1AB, and Ed Day, W3CXL. It is said that a list of the amateur stations heard at Little America would fill a book! KFZ, at the base, calls CQ at 8:00 p.m. E.S.T. each evening (unless busy with WSL or NY1AB, in which case they call CQ after they are clear), using 12,460 or 11,040 kcs. and listening for amateurs in the 14-mc. band. The period between 8 and 10 p.m. E.S.T. is usually devoted to this 14-mc. work. Operator Waite, KFZ, calls CQ on 8290 kcs. and listens for amateurs in the 7-mc. band daily after midnight E.S.T. The S.S. *Jacob Ruppert*, KJTY, and the *Beard of Oakland*, WHEW, are both at New Zealand. KJTY works NY1AB daily at 7:30 p.m. E.S.T., KJTY using 16,680 kcs. and NY1AB 14,200 kcs. KJTY (8290 kcs.) listens in the 7-mc. amateur band about 4:00 a.m. E.S.T. Both W3CXL and NY1AB soon will be unable to continue traffic schedules with KFZ, and are looking for some reliable operator with a good station to take over the work. If interested, get in touch with W3CXL or NY1AB at once.

## 718 Attend Boston Hamfest!

Smashing all records for New England ham gatherings a hamfest was held at the Hotel Bradford, Boston, on February 17th, under the auspices of the South Shore Amateur Radio Club and the Eastern Mass. Amateur Radio Assn. The committee in charge consisted of W1ZK (Chairman), W1KH, W1ASI, W1GL, W1ACH, W1AKY, W1AJA, W1SB, W1SC, W1CPD, W1DK, W1DFE, W1WX, W1AKN, W1CGM, and they are to be commended on doing the job up brown! Talks included one on Class B Modulation by Mr. Quimby (Delta), one on Tubes by Richard Purrington (Raytheon), and one on Station and Antenna Adjustment by Paul A. De Mars (Yankee Network). An Army Amateur meeting under the direction of W1PI and W1COL, a Naval Reserve meeting under Lt. R. B. Meader, a Phone meeting under W1SL, and a Traffic meeting under the E. Mass. SCM, W1ASI, wound up the afternoon. A feed in the evening was followed by short addresses by C. C. Kolster, R. I., Director Bailey, W1KH, and Mark L. MacAdam, W1ZK, Joe Mullen,

WIASI, acted as Toastmaster. An unique (!) initiation into the "OT5" Club was staged by Harry Sawyer. WIIS! Three solid hours of prize distribution brought this gala hamfest to a close. All who attended hope it can be an annual affair, and the sponsors plan to try to make it so.

Numerous amateurs made use of the informal 10th Anniversary Transocean Tests, January 1st-15th, to make new DX friends and renew some old DX acquaintances. During the fifteen days W1BUX, a well-known DX hound, worked 28 foreign amateurs on 14 mc. and 8 on 7 mc. W8JTT took advantage of the tests to make his first European contact, EA1BC, on 14 mc. W3AWS celebrated the "10th Anniversary" by working nine DX stations, including SUIEC on 7 mc. No matter how much we progress, there is always a thrill in real DX work—even the old-timers will tell you that. It's something to have friends in the four corners of the earth!

W6GUK, NCR Control Station Unit 4, Section 5, 12th Naval District, will send code practice on 1900 kc. from 7 to 7:30 p.m. P.S.T. each Wednesday and Friday. W9MQM, code practice station at La Grange, Ill., has changed operating frequency to 1945 kc.

#### W9USA—WORLD'S FAIR

The World's Fair Radio Amateur Council will again hold an exhibit of Amateur Radio at the 1934 "Century of Progress" Exposition. The exhibit will be complete in detail, but radically different than last year's activities. A complete amateur station will be in operation, using the call W9USA. Any properly licensed radio amateur may operate W9USA provided he brings his license with him. A few sure-fire reliable schedules will be maintained, but as much time as possible shall be kept free for general operating by guest operators. W9USA will be located in the Lounge Room of the Radio Exhibit. Plans call for 2000 square feet of apparatus exhibits and new methods of showing amateur radio to the public. Amateurs visiting Chicago this summer should not fail to look in on W9USA and the Amateur Radio Exhibit at the World's Fair!

OM Middleton, W4CA, and his YF are leaving St. Petersburg, Fla., about May 15th for a long trip through the South, Southwest, West and Northwest. The first leg of the trip will be via New Orleans across Texas into Arizona. A self-contained crystal-controlled portable rig will be taken along in the car, and will operate under the call W4CA (BT 4-5-6-7, etc.) on 14,387, 14,008, 7193 and 7004 kcs. W4CA is very anxious to QSO stations in Ohio for QSP by mail to Cleveland (where Middleton operates as W8UC). Watch for W4CA and cooperate wherever possible.

#### O.B.S.

The following is a supplement to the list of A.R.R.L. Official Broadcasting Stations in September QST (page 44): W1EBM, W1WR, W3DLF, W6FRP, W8HCS, W8KJW, W9DEL.

#### ATLANTIC DIVISION

**E**ASTERN PENNSYLVANIA—SCM, Jack Wagenseller, W3GS—RM's W3MC and W3ALX. Following make BPL: W3CL, AAV, DZ, SB and W8CVS. W3ALX has new car. W3BIP, BWP and W8FLA are rebuilding. Reports were phoned in by W3CTB, BYS, QV, EH2, DZ and MC. W3BUI is operating portable in 8th district. W8INA has new bug. W3ABZ, ABE and SE reported in person. W8DIG reports W8EOH on 8th case of pneumonia. W8CFF has new super. W8IXC is DX-ing. W3DGM and OK reported via radio. W8VD has home-movie craze. W3DXQ handled a message to Governor Pinchot. W8LCU wants schedules. W8JKZ has new power supply. The Western Radio Society held a "radio

amateurs' dinner dance," nearly every amateur bringing his OW or YL. A nice station schedule card can be obtained by dropping a card to the SCM. Starting Sunday, April 29th, and every Sunday thereafter, the SCM and RM's will be on from noon to 1:00 p.m. for QSOs with ORS of this Section. SCM and RM's will all be on approximately 3655 kc. This is the beginning of an ORS Net. Be sure to be on and watch for further details. W3CUG is making a 3.5-mc. rig. W8ION, W3EIM and DXK send first reports. W3EMT is new station.

Traffic: W3CL 862 AAV 610 SB 527 BYS 414 ADM 400 OK 392 DZ 330 ALX 313 AQN 294 AKB 291 MC 278 ABE 271 EZ 191 DXQ 126 EH2 124 EDA-CPJ 86 ADX 76 BIP 80 DRO 63 DGM 60 CB 57 GS 47 DYX-QV 33 DWZ 29 CTB 14 BUI 15 ADE 7 ABZ 4 EER 2. W8CVS 516 IWT 151 CFI 132 FLA 69 VD 55 INA 32 DIG 24 LCU 22 LXC 10 CFF 8 AGE 6 DXK 5 ION 7 JKZ 4.

MARYLAND-DELAWARE-DISTRICT OF COLUMBIA—SCM, E. L. Hudson, W3BAK—RM's W3CXL, CQS, CJS; Chief RM W3BWT. The Western Maryland Amateur Club has been organized at Cumberland. "CQ BALTIMORE" is a magazine being published in Baltimore in the interest of Amateur Radio. W3DUK and AJH worked PA0ASD on 3.5 mc. W3CRB has worked all "W" and "VE" districts on 3.5 mc. with 10 watts input. W3CXL handled about a thousand messages for the Byrd Expedition. W3CTD built tri-tet. W3BGI is trying 56 mc. Following make BPL: W3CXL, BND, BWT, CQS.

Traffic: W3CXL 2457 BWT 889 BND 451 CQS 187 ASO 112 BAK 89 CTD 51 BGI 24 CDG 43 AHZ 19 BHE 10 EHW 7 BRS 5 DKM-DML 1.

SOUTHERN NEW JERSEY—Gedney M. Rigor, W3QL—W3DHX will QSP anytime. W3CYI reports ELG new ham. W3DQO is on at Millville. W3ECE just started to squeal. W3VE and EDP want ORS. W3ZI sends about 20 3.5-mc. off-freq. reports per month. W3APV reports activity on coming Hamfest in Atlantic City. W3AVJ reports good DX. W3DFC, A/J, CAD, AIU, DPE, CRK and DSC have gone c.c. New Trenton hams: W3DCQ, EFN, EGE, EFF, DXT, BEQ, EED. W3CWL reports a large traffic month. W3AZZ joined A.A.R.S. W3EJV reports from Chatham. W3ZX reports transcon schedules functioning regularly. W3CNI has a young YL opr. A Hamfest was held in Camden by the Greater Camden Radio Club.

Traffic: W3CWL 202 AZZ 28 AVJ 33 DST 15 DXA 2 BUB 16 BQC 6 EDP 8 DPE 15 VE 49 ZI 147 CQO 1 APV 114 CNI 2 DQO 14 DHX 8 KW 6 QL 2 ZX 17 AN 4.

WESTERN NEW YORK—SCM, Don Farrell, W8DSP—Following report by radio: W8GPV, KMC, JTP, IY, AOW. W8KBT and AYD are in Elmira Traffic Net. W8JSD is traffic manager for Mohawk Valley A.R.C. W8KXL is looking for YL ops. Fort Stanwix Club has 22 members. Mohawk Valley Brass Pounders have a crystal filter for FB-7. W8BAI operates WPGJ. Utica Amateur Radio Club has a total of 45 members. W8JE handled thousands of words of Byrd traffic through NY1AB and K5AF. Anyone wanting Syracuse schedules write W8EMW. W8DBX has seven daily schedules. W8FSY has exchanged over 500,000 words with W1DQK via 1.75-mc. 'phone. W8AWX was in DX Contest. W8DSP is building tri-tet. W8JTT can take traffic for Hawaii and Orient. W8AGS and AFM spend most time on 'phone. W8JAK has trouble with universal exciter. W8JJJ reports activity around Glens Falls. W8FTB is editor of new publication, "The Radio Scout." W8BR has six schedules. W8IMR has c.c. W8GWT wants Rochester schedules. W8EWP is winding power transformer. W8JQE blew 'Sls. W8GWZ has a 21l. W8GWY has portable ready for emergency. W8DEU worked a ship in North Atlantic. W8FYF built new rig. W8GZM is back at O.C.L. W8AQE is minus "B" supply. W8AAR is rebuilding to permanent installation. W8BHK reports S.T.T.A. had to cancel meetings on account of weather conditions during winter. Western New York Radio Assn. has FB speakers at meetings. W8EDA blew 50-watt. W8AXE schedules Sherrill. W8IY is doing nice work as RM on

1.75-mc. 'phone. Any active men interested in becoming Route Managers please write SCM. New calls: W8LMR, LHP, LGR.

Traffic: W8JE 1556 EMW 633 DBX 431 AIE 358 AYD 274 FSY 276 AWX 240 GPV 128 KMC 103 IY 223 AOW 242 DSS 42 BR 21 GWT 78 GWY 28 DSP 13 DHU 65 KBS 19 FYF 12 JTT 56 CJJ 98 JTP 54 JAK 46 BWY 5 EBR-PTB 8 IMR 2 EWP 7 JQE 4 GWZ 5 GZM 7 AQE 1 BGO 2 KBT 4 AGS 2 JJJ 6 LLS 5.

WESTERN PENNSYLVANIA—SCM, C. H. Gros-sarth, W8CUG—W8GUF leads the Section again. W8YA handles plenty of good traffic. W8HGG has been on 1.75 mc. W8CQA is trying to get buffer perking. W8KWA has new FBXA. W8IQB is knocking off DX. W8HMJ is now c.c. W8GJM gives code lessons on 1.75 mc. W8HQL has Class A endorsement. W8DFT is recuperating in hospital. W8CKO attended Hamfest at Columbus. W8KSG and AYA have new 1.75-mc. 'phones. W8ESR is moving rig into his office. W8KRQ has worked all W's and VE's on 3.5 mc. The Atlantic Division Convention will be held in Pittsburgh, Pa., June 22nd and 23rd. Mark the dates on your calendar!

Traffic: W8GUF 789 YA 520 HGG 44 CQA 41 KWA 38 CUG 18 IQB 7 AXD 9 EEC 8 CMP 4 HMJ 3 GJM 1 AYA 2 KRQ 1.

#### CENTRAL DIVISION

ILLINOIS—SCM, F. J. Hinds, W9APY-W9WR—RMs, W9CRT, W9DDE, W9ERU. There are now six Official Phone Stations in Illinois as follows: W9ACU, AVB, COW, EQX, HQH, and IKQ. Ex 9BBL is now W9OD. W9EFQ is moving to second floor. W9KA WAC'd in 48 hours, 24 minutes. W9RO married again. W9EVJ highly lauds the A.A.R.S. W9LZU is building transmitters for 1.7 and 3.5 mc. W9OQ is on 3.9-mc. 'phone. W9CKM heard his YL say "Yes!" W9FYZ is editor of "Podunk News." W9KEH was in DX Contest. W9IKQ has low power rig. The Chicago A.R.C. is now affiliated with A.R.R.L. W9OMA is a printer. W9OXA, OVS, OZJ, OYG and PVG are new Streater hams! W9OLW and PSP held continuous QSO for 7 hours and 40 minutes. W9PQM and CUH work 1.7-mc. 'phone. W9GKH has regular schedules. W9HYI sends report from WIND in Indiana. W9HPG is getting into traffic swim. The OM's YL is a nurse across the street in the hospital, and W9MIN is playing *Wenona Daily News* and Curip, Inc. W9AWA was used as portable at Boy Scout Merit Badge Exposition; they were helped out by W9BTT, HTS, HUU, MLJ, CUN, LZE, INZ, MAP and HGE. W9GYF is on Navy Drills. W9GLW worked VK and HK. W9FLH WAC'd in 41 hours. New frequency meter at W9HPK. W9GET is on 3.5 mc. Power pack at W9PEX went west. W9JO worked all continents but Asia first day of test. W9MFA calls CQ "G" on 1.7-mc. 'phone. W9OJJ enjoys A.A.R.S. W9IBC has a Class "A" ticket. W9BPB worked ZS, ZL, VL and VE. W9LOJ has worked 16 countries, 5 continents. W9KSB is getting S.S. receiver. W9LTC is going 56 mc. W9JJR received unlimited ticket. W9LIV uses an indoor antenna. W9FGV is leaving Illinois. W9FO got R9 from ZS2A. W9LNI is breaking a dentist into ham game. W9GPK is changing to Goyder Lock. W9LXX's new Silver Super is FB. W9GJP is at work on new rack and panel. W9MKK is building c.c. 'phone rig at W9NNH.

Traffic: W9KJY 817 EVJ 755 MDL 565 ILH 512 HPG 223 MIN 196 MLH 182 CGV 145 NV 139 AWA 129 EZQ 111 LZU 105 JO 88 FGV 69 NN 68 IGN 75 ORT 63 KJX 57 OMA 55 OJJ 42 MKK 41 IEP 40 DBO 35 DJG 28 FCW 27 HQH 25 GKH 21 PSP 18 FXE-OSQ-SG 17 EMN 14 LNI 12 ATS 10 AVB-MKS 9 CUH-KA-KEH 7 FTX-IBC-LCW 6 OKC-GLW 5 IWP-LOJ 4 GYP-HPK 3 BPU-PTW-WR 2 NFL 1 PHX 4.

INDIANA—SCM, Arthur L. Braun, W9TE—Write the SCM for a copy of the "Hooster Bull" sheet. A copy is sent to all who report. W9APV and JLH have been on 14 mc. W9BCP has new '03A. W9CUZ worked a W6 at 9 a.m. on 3.5 mc. W9CTT is QRL A.A.R.S. W9DET can use a few schedules. W9DJJ likes QSO parties on 1.75 mc. W9DPL likes to chew the rag. W9DGC worked ZL,

TI, HC. W9FRY is back from Florida. W9GGP has new 8-lb. boy! W9HML is changing to early morning schedules. W9HUV reports DX fine. W9HTP has new ant. W9HUU is doing fine as ORS. W9HBF has new Super. W9HPQ and JRK are QRL traffic schedules. W9LRH worked a VK5. W9LLV is on 1.75-mc. 'phone. W9MBL likes c.c. W9MIG says the ant. coupling in Feb. QST should be tried. W9MMI got married. New c.c. rigs: W9PLW, NCT, OXG. New A.A.R.S.: W9EGQ, OXM. W9YB is working hard on hamfest. W9JST is giving tri-tet a try. W9LWK is kept on air by PKK. W9JTU is new Alt. D.N.C.S. A.A.R.S. W9QR says one '46 perks better than two. W9PVS lets the XYL work his 'phone for best results. W9JRR is building rack and panel. W9DBJ worked a ZL. W9OFG has a pair 47's final. W9QG worked X, CM, TI, EA, NY. W9HUF is new ORS. W9LSZ visited W9TE.

Traffic: W9NCT 9 HPQ 6 BCP 50 CTT 73 DET 31 DPL 3 DGC 1 EGQ 9 FRY 1 HBK 29 HML 15 HUV 1 HTP 23 HUO 11 HSF 8 JRK 171 LRH 6 LLV 30 MFW 52 OEC 8 OXM 16 YB 62 HUF 50 JOQ 6.

KENTUCKY—SCM, Carl L. Pfumm, W9OX—W9KKG wins this month's '10 prize for highest traffic total. A pair of '66s, subscriptions to QST, and other valuable prizes will be given to winners of our new monthly QSO Party now in progress. W9ETT has 750 points in first round. W9CNE is "gonna take" Johnny in next party. W9ELL made WAC during DX Contest. W9ARU is building new gadgets. Since W9JYO is now official score-keeper in Ky. Contests, Chief RM W9BAZ will have plenty time to organize some good Ky. routes. W9OX finally snagged, W9HAX! W9CDA can't decide between a crystal oven and 0/1500 voltmeter! W9EDQ craves more traffic. W9FQQ's new rig: 47-46-10's. W9OMW is new ORS. W9AQV, IPG and ERH are on 1.75-mc. 'phone. W9AUI is "talking up" a Ky. Ham-fest. BPL is goal of W9KPT. W9LXN is reorganizing. W9NWR thinks we need a QRI Party. W9MWR and IFM are neighbors on 3.5 mc. W9BAN is worrying about 400 cycles his frequency meter lost during 4 months. "Six below zero in shack" accounts for W9OFE's low total. W9BWJ says WLW copied their new Mae West Tower after his 73-footer. W9HBQ, Sec'y of A.R.T.S., invites correspondence from other clubs. W9PLM, NEP, LBX, EYW are installing tri-tets. W9ACD is increasing power. W9KCV moved to new location. W9HC0 is on 14-mc. 'phone. W9EDV increased power to 150 watts. W9FGK mastered link coupling. W9ZZQ-OZO-NBD-EOM-GUJ-FZV report. Report on the 16th if you want your copy of Ether Clippings.

Traffic: W9KKG 258 ELL 184 OX 173 ARU 126 CNE 114 BAZ 109 BWJ 91 ETT 86 HAX 70 CDA 58 EDQ 34 FQQ 31 OMW 29 ERH-AUH 23 EOM 27 KPT 23 ACD 18 IXN 17 NWR 14 MWR 13 BAN 12 KCZ-OZO 11 OFE-HBQ 9 FZV-PLM 7 FGK 6 IFM 5 GUJ 4 EKB-NEP-CKH 3 HCO-EYW 2.

MICHIGAN—SCM, Kenneth F. Conroy, W8DYH—THE MICHIGAN NINES: W9CWD is OPS No. 6. W9DSJ is on 56 mc. W9LLD is QRL in cold WX. W9LUU says he may have c.c. perking any year now! W9MJW reports FBC going c.c. It may be a new deal to most of us, but to W9IOV it's just another poor hand. Hi. W9BBP labors long and hard. W9LDC's '45s work FB when they work! W9NEZ used to be moulder OPR—then W. U. OPR and now motion picture OPR. W9CEX, OZM and EQV keep things whirling in Dollar Bay. W9OVX uses '45s TNT. W9MXN reports POC active. W9IAO reports PQN new in Calumet. W9CWR finds ski-jumping another way to get DX via the air! W9ADY took the W9PCU (YLs at Isle Royale) report this month. W9BWU worked 135 miles with 135 volts on phone. W9CE and PDE keep Ishpeming hot. W9HIS is doing FB work with Conservation Emergency work. FB, Lake Superior Radio Club, on your nice Bulletin. THE MICHIGAN EIGHTS: W8AEQ is RM of N.W. portion L.P. Congrats to W8GHP on new YL Jr. Opr. W8NQ uses 0-1 m.a. with rectifier for field measurements. W8BRS put receiver in grocery store so he can order by air—3 miles away! W8GMB's new 211E lasted just 5



minutes. W8JGR is a fireman. W8AW runs FB column in *Detroit News*. W8HSH has his in Ann Arbor paper. W8AKN has P.A. ready for D.A.R.A. Hamfest, May 20th. W8EGE goes big for Collins Impedance Matching System. W8EKT is new OPS. W8DWD and GHP use filtered spark coil supplies. Will the bird using W8CUX's portable call, W8FUL, learn how to keep in the band, please? W8EBQ is planning a portable. W8FTW, Detroit RM, told FRC he was keeping bunch of skeds and got license back in two weeks. W8CEU is head man this time. Copies of the D.A.R.A. Bulletin go to any Michigan amateur reporting to SCM each month. W8GUC/WLTC keeps four schedules. W8FII is working for ORS. W8DWB handled Conservation Dept. Emergency traffic. W8JO, W8AEQ, W9HIS, W9CWD, W9EQV and W9PCU all deserve much credit for putting amateur radio aca-high with Conservation Dept. W8DZD schedules a few. Many report fine time at Kazoo Hamfest. New MOPA at W8IKO. W8BBH will be at D.A.R.A. Hamfest, May 20th. RM W8EGI is coming on with c.c. W8QT tells us BMG wanted to buy the City Hall again! W8DED—DX Contest—"nuf sed." Central Mich. Radio Club of Lansing—W8CED, Pres.; W8JO, Vice-Pres.; W8GJK, Secy.-Treas. W8CFQ new power supply blew final 250-wattier—using '46s now! W8IGA's Bulletin FB. W8FAV was at Kazoo Hamfest. W8KOX has freq.-meter completely de-loused. But three of W8ADU's last 17 QSOs were with W's! W8DNM froze up. W8CSL reports Oxford A.R.C. Party very successful. W8GRN is doing extra FB for power used in DXing. W8GQS' commercial looking job wouldn't perk as well as the haywire! W8CAQ, reports W8LFE, still has the chin up in spite of a "Bendix" operation, out of work and all apparatus destroyed by fire! W8ZC got nice write up in paper. W8HSH had to put ears in ice-pack after DX Contest! W8ETP's YL now belongs to W8EBN.

Traffic: W8CEU 805 FTW 594 AEQ 435 DVC 351 GUC 290 FII 106 DWB 140 DZ 109 ERX 93 IYN 68 LAL 61 GSP-EL 50 JO 48 IKO 41 BHH 40 EGI 39 FX 38 IOR 36 BMG 35 QT 30 GDR 29 EHD 25 FDX 25 DED 24 CFQ 23 GJK-ICM-IGA 20 FAV-KQT 18 GQB 17 NR 15 HBZ 14 ARR-KOX 13 AYO-DYH 12 KMT-VC 12 ADU-DNM 11 HA 10 CFZ-JTV 9 CFM-CSL-FEE-GRN 8 AIJ BRL-GOV-GQS 7 CPH-IFE-ZC 6 DSQ-FXB-HSH-IBH 5 CPY-DUR-GRB-IFD-IWM-JNK 4 BTK-KYS 3 AW-BTP-DIV-JGR-WG 2 WA 4 DPE-EBX-JZD-KLR-KSY 1 W9ADY 99 PDE 76 HIS 65 EQV 58 CE 54 BWU 48 PCU 48 CWD 22 CWR-FBC-IOV 19 BBP 13 LDC 9 NEZ 6 CEX-OVX-OZM 5 LUT 2 MXN 1.

OHIO—SCM, H. A. Tummonds, W8BAH—Chief RM W8PO E. Heck, Shelby, Ohio. Dist. No. 8: W8PV operates at WLW. New Vertical antenna at W8FSK. W8IBN helped with antenna. W8LON and LOY are new hams. W8BTI scheduled KAINA. W8BKE schedules VE3TM. "From movie operator to dairyman," reports W8CUL. First report from W8LCK. W8BRQ reports following active in Cincinnati on 28 mc.: W8EDX, EGQ, FIV, GBI, FHZ and HSO. Dist. No. 2: W8EEZ, RM, is now on shift job. W8FNX worked all districts. W8ANU says new club active. W8LNX reports OT W8KK back on air. W8EJ visits SCM. Dist. No. 3: W8LCY wants ORS. W8JES schedules W8ICC. W8ESN has six schedules. W8APC, RM, operates at W8BAH while in Cleveland. W8FUO, new OPS, sent broadcast for Tiffin police department on post office robbery. Dist. No. 4: W8JGZ originated California traffic. W8DND reports for W8JEA, LEU, RT. W8PO says, "Ohio gang, get that portable rig in working order." W8EMH helps would-be hams with receivers. W8ICC joins A.A.R.S. W8UW, RM, is now WLHI A.A.R.S. A.S.N.C. W3FZ is now at Ada, Ohio. W8HTH makes QSL cards. W8JB reports FB meeting of Intercity Radio Club at Bucyrus. W8VE applies for OBS. Dist. No. 5: W8FGV RM. W8BMK uses SW3. Tower toppled at W8JTL. W8AMF transmitter was inspected by Army Federal Inspection Board. 175 watts to final at W8BDG. W8KLP is busy on coming hamfest. W8GMI reports that W8HPD, KNF, EMV and DXB of Medina County Radio Club are all active. Dist. No. 6:

Acting RM W8GSO. W8KQO schedules W9OQB. W8EQC has ½-watt portable. '47 crystal osc. at W8ISK. W8BBH says, "A.A.R.S. only." Hamfest kept W8AEL from big total. W8GZ leads state with 2554! Dist. No. 1: RM W8BON. Phone at W8BRB. Two-band operation at W8LKT. W8FGC worked Europe. W8KZL is building 1.75-mc. 'phone. 6 watts input on 1.75-mc. 'phone gets DX for W8KJK. ½ traffic ½ ragchew at W8HGE. W8IMJ is call of Lakewood Radio Club. Five schedules at W8EPP. 1000 volts on final at W8DVL. W8RN is trying tri-tet. W8CJO schedules Army stations. W8EEJ entertained Old Timers' Club of Cleveland at his home. Chagrin Falls is shown in picture on new W8HYZ QSL card. W8BAC is changing to MOPA. New crystal mike at W8KIP. New rig at W8LOG. W8DXB and KIP apply for OPS. W8DLD and DKK are lining up schedules with Little America.

Traffic: W8GZ 2554 CIO 557 RN 370 BBH 146 DVL 143 BON 134 UW 107 HCS 105 ISK 97 BDG 78 EPP 66 EBY 61 FFK 47 PV 55 IMJ 48 HGE 41 ESN 39 ICC 38 GSO-EJ-VP 32 FGV 30 CUL-HMH 27 BAH 28 JES 24 KJK 23 PO 21 LCY 18 AMF 23 BKE 17 UX 16 INX 14 WE 11 ANU 11 EQC-BTI 10 FNX 9 JTI 3 EEZ-BFT-KQO-IZQ 8 DND 5 LCO 4 FSK-DZO 3 KZL-FGC-ANZ 2 JGZ-LKT-BRB-BMK 1. W8FZ 109.

WISCONSIN—SCM, Harold H. Kurth, W9FSS—W9HSK leads state. W9ATO wants schedules. W9AKT upholds Madison's traffic status. W9NSM and OKS apply for ORS. W9IQW is coaching beginners. W9HTZ discovered how tough Annapolis exam is. W9GVL believes DX is rich man's hobby. W9JCH is thinking of 14-mc. 'phone. W9ETM makes ORS. W9GWK is at U. of W. W9LFFK works hard on R.M. duties. W9JDP is back to work after strike. W9FSS is "cracking" radio books. New hams: W9PFF, PZN and PRA. W9JWN begs for publicity regarding his 1.75-mc. 'phone work. W9OME asks, "Does it hurt a '46 to get white hot?" W9AKY and EXH like 1.75-mc. 'phone. W9PJS has tri-tet. W9NAV is building super. W9DTK, AFZ and SO are building NCR station.

Traffic: W9HSK 205 ATO 94 AKT 70 OKS 52 NSM 47 IQW 36 HTZ 31 GVL 31 JCH-ETM-PAQ 22 HMS 17 LFK 13 GWK-OPX 10 DNU 2.

## DAKOTA DIVISION

NORTH DAKOTA—SCM, Wm. A. Langer, W9DGS—W9PDC uses '46s in final. W9PAI is building rig for 1.7 mc. W9PHH reports for Grand Forks. W9KQF, MZE, and JMW are active on 3.5 mc. W9DIW blew a '10. W9NAW worked K6, K7 and CM. W9PGO lost power supply. W9BTJ uses 800 buffer. W9EVQ uses tri-tet. W9LHS will have '03A final. W9GTB uses '52 Hartley. W9JZJ gave code exam to W9PMI's sister. W9EJ got his Class C. The SCM is playing with 'phone.

Traffic: W9DGS 124 HJC 103 PDC 43 PAI 40 DYA 20 PEH 19 PGO 18 JZJ 14 FSF 9 BTJ 6 EVQ-KZL 4 LHS 3.

SOUTH DAKOTA—Acting SCM, C. B. Davis, W9AZR—W9DKL says, "It is with regret I must leave S. Dak., having received employment in St. Paul, Minn. I hope you will give W9AZR your support. My address is 5 Iris Place, St. Paul, 73." W9DGR reports traffic light. South Dakota is making bid for Dakota Division Convention. W9IQZ moves to Pierre.

Traffic: W9AZR 239 DGR 2.

NORTHERN MINNESOTA—SCM, Robert C. Harshberger, W9JIE—W9JID is moving from Section to C.C.C. Camp. Good luck, OM, thanks for your good work. This leaves a vacancy in RM position. W9PAN is on 7 mc. W9OBE has '03A. W9ISA visited S.P.R.C. and SCM. W9OOO and OMI join A.A.R.S. W9HDN worked ZS and VK. W9BVI pushes brass at 9VC. W9OPA has 1.7-mc. 'phone trouble. W9AVZ is comm' on op on freighter. W9IDJ is back in Two Harbors. W9HNS worked F3MTA. W9FTJ signs up for U.S.N.C.R. W9LFO hits traffic hard. W9PZU is new Staples ham. W9DGM is op at WCCO. W9HEN is c.c. W9IQZ joins A.R.R.L. W9GLM is on after year silence. W9JCD, JHS and BHQ are on 14 mc. W9PFR wants a couple schedules. W9OVQ is c.c. on 7 mc.

W9OOU reports via radio. W9IPN uses Collins ant. coupler. W9HRB is on 14-mc. 'phone. W9BBL is trying to improve 'phone operating conditions. W9JIE is putting in Class B 800 mod. W9EXR moved to St. Paul. W9LIP will be on with '49 soon.

Traffic: W9PAN 3 OMI 6 OOO 11 HDN 38 OPA 1 HNS 25 FTJ 1 JID 14 LFO 237 IQZ 33 PFR 4 OOU 44 IPA 61 JIE 28 IPN 148.

**SOUTHERN MINNESOTA**—Acting SCM, Francis C. Kramer, W9DEI—W9BKK makes BPL 5th consecutive month! W9FCS, FNK, and EGG were slighted by DX stations in contest. W9DEI has worked all states. W9AQH eliminated BCL troubles. W9BN, DEH, and JQA are QRL work. W9AIR handled KFZ traffic. W9GLE is rebuilding with a '10. W9BHZ reports DX FB. W9ZT has new 100-W. temperature-controlled outfit. W9BNN visited many So. Minn. stations. W9MZN has new universal exciter. W9OAK plans on handling traffic. W9PJH keeps schedules with particular BCLs! W9GNU says ORS parties are lots of fun. W9RAU is newest addition to Rochester gang. W9CVA uses Class B modulation. W9MNT wants 7-mc. schedule for Saturday afternoons. W9KDI works DX. W9LEN, IDF, and ANU are active. The S.M.R.A. meeting held in Rochester, March 4th, was well attended. W9AIR won the Grand Prize.

Traffic: W9BKK 520 FCS 107 DEI 70 AQH 56 BN 49 ATR 16 GLE 13 BEZ 9 DH 8 ZT-BNN 7 FNK-MZN 5 OAK-PJH 3 GNU 2 EGG 1.

#### DELTA DIVISION

**ARKANSAS**—SCM, Henry E. Velte, W5ABI—Our sympathy to W5BDR in the loss of his mother. W5BDB has five 'phone schedules. W5SQ, BED and ABU are building new rigs. W5AXP and BDB are on 14-mc. 'phone. W5DYL uses pair of 45's. Ex-W9OQN is portable at Hughes, Ark. W5DRY is new A.A.R.S. W5DVJ is BC servicing. W5DRW is changing power supply. W5CVO and ABI have new receivers. W5CZG and DVI operate together. New stations: W5DVA, DUS, DWD, DZE, W5DVR worked "EA" and "ZS" for DX. W5BMI and ASG have WAC certificates. W5BUX uses Class B modulation. W5DSW and DFZ are on 'phone. Ex-W5ANN is now W5DYX. W5QJ is busy with A.A.R.S. W5ABL puts out nice signal. All stations are invited to send reports to SCM each month on the 16th. Let's pep up, fellows!

Traffic: W5BMI 639 DRY 43 DVR 20 BUX 18 CVO 15 CZG 10 ABI 10 DSW 3 DHG 2.

**LOUISIANA**—SCM, W. J. Wilkinson, Jr., W5DWW—VT—W5NMI is on a cruise. W5AFW was married April 2nd. Congrats, Phil. W5CQF-ZV is trying to organize traffic net. W5AXU is putting equipment in rack. W5AOZ works lots of DX. W5KC works overtime at P.O. W5BZR reports four stations on air in Minden. W5AGM received DX cards. W5BDJ is trying to organize N.A.R. Net. W5QH has been instructing young fellow in radio. W5EAI is new Shreveport station. Shreveport will entertain visitors to Louisiana State Convention in Shreveport, Sept. 1st-2nd. W5DVP will handle traffic for Barksdale Field. For information concerning membership in The Audion Club, write W5VT. W5BI was chief operator at Pan-American Air races—W5DWC and DBW also operated at races—The New Orleans Radio Club is now affiliated with A.R.R.L.—W5ST has new c.c. rig—W5DKR reported for a flock of N.O. fellows.

Traffic: W5BZR 113 DVP 23 YW 3 AOZ 2 DMP 4 DKR 8.

**TENNESSEE**—SCM, F. F. Purdy, W4AFM—W4BBT keeps W4PL's schedules while the latter enjoys a Florida fishing sojourn. W4AEP claims the "Down State boys" are plenty active. W4CU and FK are having trouble getting licenses. Look at your license date, fellows, and renew before it expires. W4BGC has gone to Mexico. W4ABY is on with one kick-a-wallop 'phone. W4TD uses tri-tet. W4VT and BWH built new supers. W4AQD is attending University at Knoxville. W4AGW has "OW QRM." U.S.N.R. is staging a membership drive under guidance of W4OI. W4ALM wrecks tubes wholesale! W4BOA and BCA are active in NCR. W4BPC, our second

OPS, is active on 1.7 mc. W4BOZ is keeping Big Bad Wolf From The Door. W4RO will take over duties of S.N.C.S. for Tennessee A.A.R.S. W4AFM is busy with fourth corps Area Radio Net. How about more reports, Gang?

Traffic: W4AFM 573 RO 234 BQK 35 BPE 18 BBT 217 AEP 60 BPC 24 OV 19 CBA 7 BTQ 4 EX 2 BMH 1.

#### HUDSON DIVISION

**EASTERN NEW YORK**—SCM, R. E. Haight, W2LU—W2EFG is high man! W2BLU reports GXM new station. W2BJA's schedules are perking perfectly. W2EQD says new club at H.S.: EQD, pres.; FUM, secy.-treas.; EQC, chief-tube-cleaner. W2GNI and CLL have new c.c. rigs. W2BWB and GFH on 1.7-mc. 'phone. Crystal goes in W2FPH's new rig. W2ENG is on 3540 kc. W2FAM is playing with 7 mc. W2SZ was QRL DX Contest. W2BSH worked W1MK. W2CC QSO's all members of Hutchings family, VK3HM-VK3HQ-VK3HL. W2KW is QRL Law game. W2UL sends nice letter about Mt. V. hams. W2EMK was on 3.5 mc. during DX QRM. W2BPH is an ole-timer back on air. W2CFU and DC made nice totals in DX Contest. W2ACY reports J2GX QSO W2BKW. W2FEQ is on with new rig. W2ATM is looking for crystal. W2GTW reports traffic in his favor. W2BRS schedules W2GLL. W2DSH and DC are new ORS. W2BLU rebuilt. W2DC and CAZ are new OPS. W1EFM-2 digs out from the snow bank. W2CJS is trying to get tri-tet on air. W2QY is lining up for 28 mc. to schedule CIF. W2ESO reports 7-mc. FB for DX Contest. W2GMM increased power. W2CSM and DUL have 830's. W9KWT and W2GTC visited W2LU. W2AJE reports AQN and FEF active. W2FXC is RM3 in NCR. W2BZZ makes first report. W2CVL applies for ORS. W2BZZ reports spring cleaning.

Traffic: W2EFG 411 BLU 300 LU 195 BJA 175 EQD 90 GNI 29 FPH 18 ENY 50 BSH 12 CC-GFH 10 KW 12 UL 8 ACY-FEQ 7 ATM 12 GTW 5 BRS-DC-DSH 3 BLL-CJS 2 AJE 8 CVL 10 GPB 11 AJE 2. W1EFM-2 2.

**NEW YORK CITY AND LONG ISLAND**—SCM, E. L. Baumach, W2AZV—New ORS: W2CSO, AYJ. Out for ORS: W2GWS, W2FIP has BCL QRM. W2EGA and BGO are trying tri-tet. W2EYQ has four stage 50-watt rig. W2EQA is QRL school work. W2FDQ is inventing new self-excited rig. W2CEH is working on new line of transformers. W2FST got his commercial ticket. W2ATD prints own QSL cards. W2BEF works great DX. W2AXN claims jobs are scarce. W2BJP has 211D. W2CPY says GHV has new Jr. YL op. W2CYA was in bed with the "mumps." W2BTF worked 5 VKs in 3 mornings. W2BLJ wants a Comet Pro. W2DOG enjoyed a visit to HQ. W2BSR and UK put in their licks at the DX tests. W2AOA is married again. W2EQL and DXO are rebuilding. W2AIZ is busy sending messages to all the YLs he can find in the Call Book. W2AHC, AZS, DJO are DXing. W2FMC thinks there is something to traffic handling with schedules after all. W2AYJ has several would-be hams on the way. W2ASG worked HB9AD on 3.5 mc. W2GMP says FYZ has new TRF receiver. W2CHK handled month's traffic in three days. W2PF, EKD, and DQW keep Army Net going. W2DXK has a 211 on 1.7-mc. 'phone. W2GOW installed portable rig in his car. W2FET, EYS, BEG and FGO are on 56 mc. W2BRB sent message to Lab. when marooned in recent snowstorm. W2CFE can be heard with a Collins 4A. W2DTE holds a Class A ticket. W2GUK reports for De Witt Clinton High School operated by W2DCF, ERC, ERI and EED. W2AZV started to teach his YL the code—but?? W2EVA enjoys burning up r.f. chokes. W2FBE finds an end fed Hertz better than a Zepp. W2FCQ is active. W2CAC has homemade S.S. receiver. W2DTT is working on 3.9-mc. 'phone. W2GEI is QRL studying grand opera. W2DJP gets c.c. reports with his MOPA. W2FF is rebuilding. New reporters: W2GIC and W2EJE. W2DBQ, ELK, AYJ make BPL. W2ESK, Harlem Radio Club, held a 1.7-mc. 'phone conference; 43 amateurs were present. For further dope communicate with the secretary, care W2ESK.

Traffic: W2AYJ 582 DBQ 517 CHK 302 EYQ 235 ELK

145 AIZ 143 DJP 140 EKD 105 BGO 97 BMJ-EGA 81  
BPJ 65 DQW 64 PF 45 AND 43 FIP-GIC 33 AZV-LB  
31 ASG 29 GMP 17 CP-BKP 16 AA-CIT-ALD-FLD-  
AOV-ADW 15 QS 14 GZ-FDQ 11 EYS-FXB-BAS 10  
FF 9 CYA-GLJ-CYF 8 CCD 7 LC 6 BTF-EYB-EJE 5  
BYL-BRB-GOW-DXK 4 EQL 3 DRG-DOG-BVT-  
AGC-BYY 2 GPR-ETG-COO-CK-KJ-ARO-AOB-AQQ-  
BKY-DT-CAU-CYX 1.

**NORTHERN NEW JERSEY**—Acting SCM, Robert Maloney, W2BPY—W2DIU has installed the transmitters at the operating point. W2BCX is blasé except for his totals. W2EKM holds a code class on 3766 kc. every Sunday morning from 10 to 11 EST. W2ENZ is still ducking local police. W2CGG is open for schedules. Prayers are requested at W2DPA with new crystal on 3501. W2CIZ likes those telephone number traffic totals of Ed, Bud and Ray. W2DPB QSO'ed his 37th country. W2BXM has fine results with grid modulation. W2CTT reports sick. W2CLM and BPY worked VK3MR in the middle of the afternoon on 7 mc. W2ESX has trouble shooting his new transmitter. W2AFK suggests we have an operating contest of some sort, between this section and N.Y.C.-L.I. What do the rest of you think? W2FOP is looking for schedules with other districts. ORS applicants: W2BAI, FOP. OPS applicants: W2AMB, EWU. Stevens Tech Radio Club, W2BSC, elections: pres., W3BQN; chief op., W8KUV; secy.-treas., W2BWP. The Freehold A.R. Club has W2GCH on 1995 kc. The Memorial Radio Club obtained a club room for their exclusive use. The Raritan Bay R.C. is now affiliated with A.R.R.L. A new organization in this Section is the Rutgers University Radio Club. W2ETQ sends fine dope on Paterson gang. W2GPI got telegrapher's cramp after an all-night session at the key. W2ZC is wintering at Palm Beach. When the new SCM is definitely chosen, we hope to organize this Section and utilize the static activity—energy that this entirely metropolitan section has—may we have your cooperation? 73.

Traffic: W2DIU 2282 BCX 1138 EKM 1075 ENZ 35  
CGG 30 DPA 20 CIZ 13 CJX 14 DPB 7 BXM 3 CTT-  
CLM 1 AFK 204 BSC 187 FOP 110 ETQ 36 EIP 25 BAI  
18 GLB 6.

#### MIDWEST DIVISION

**IOWA**—SCM, George D. Hansen, W9FFD—RM-  
W9ABE, RM-W9HPA. W9LEZ, new ORS, takes the  
traffic lead! W9EIV has a new YL at his home! W9LCX  
moved to new location. W9ABE worked 11 countries, 3  
continents in DX Contest. W9GP visited the SCM.  
W9HPA is doing extremely well with organization of the  
National RM Net. W9GXU looks forward to the Con-  
vention. W9FYC installed a new doublet. W9FQT had  
the measles. W9DEA says watch his smoke! W9GSY says  
warmer. WX is cutting in. W9AWY, an old-timer, returns  
to the fold. W9EBK is putting up new ski-wire. W9KZJ  
is revamping whole rig. W9ERY is playing with "ribbon"  
mike. W9JMB reports arrival of new YL! W9NS is bust-  
ing the ether with a '49. W9FYX helps NS.

Traffic: W9LEZ 129 EIV 97 LCX 87 ABE 82 GP 69  
HPA 66 GXU-FYC 46 CWG 43 FQT 20 GWT 18 FFD  
16 DEA-GSY 7 AWY 4 EBK 2 NS 12 FYX 20. KZJ 1.

**KANSAS**—SCM, O. J. Spetter, W9FLG—W9KG and  
W9IOL C.W. RMs. W9ESL Phone RM. W9KG is still  
in the lead for high honors. W9KG, FLG and KQJ make  
BPL. W9ESL is first Kansas OPS. W9ICV uses grid  
modulation. W9FRC is on 'phone. New A.A.R.S. W9OAG,  
IQI, OQC, OER, ODU, ABG, LTG, L.W.P. W9LVS is  
on 3.5 mc. New tri-tets: W9IOL, NJS. W9RAI and RAT  
are new reporters. W9IQI handled death messages. W9JAY  
is getting c.c. rig going. W9LGV is still in Sanitarium.  
NLZ on with 45's in P.P. Rebuilding: W9LFN, GDS,  
PUX and FLG. Sunflower Club held election: W9LXE,  
pres.; LRR, vice-pres. FB DX Club at Coffeyville meets  
1st and 3rd Tuesdays, first floor, Municipal Bldg., 7th  
and Walnut; W9JUT, pres.; GDX, vice-pres.; Earl  
Wright, secy.-treas. W9AWP copied KJTY and KFZ for  
two hours. W9PGL, DMF and OHY spoke at recent  
W.A.R.C. meeting. W5DBG of Tulsa, Okla., was visitor  
at W.A.R.C. meeting. H.A.R.C. has new club rooms.

W9OQC and PB combined transmitters, and moved rig  
to the club rooms. Secretaries, please send me dope on  
your club activities. W9CUN has 400 watts input to 211,  
BSX 300 watts to '03A and DMF 160 watts to a single  
'10!!

Traffic: W9KG 1399 FLG 501 IEL 339 KQJ 310 IQI  
301 IFF 255 ICV 183 GBP 181 IOL 155 BYM 134 OQC  
94 PB 80 KFQ-AWP 78 FRC 64 OFR 64 CMM 54 LTG  
26 KXB 24 NI 21 EFE 20 EYY 18 LWP 8 HLD 6 IYT-  
FMX 5 LVS 3 LJO 1 RAI 27 GDX 3.

**MISSOURI**—SCM, C. R. Cannady, W9EYG-JPT—  
W9NNZ, BMA, CJR, BGE, FTA, RMs. W9MZZ again  
comes out first in traffic! THE ACTIVITY CUP RACE  
for 1933-34 shows W9CJR first, followed by MZD, BMA,  
AIJ, and ENF. Two more months so get those reports in!  
St. Louis: O.B.P.: W9AC is out of city. W9ZK and  
EFC are active on 3.9-mc. 'phone. W9BGE wants dope  
on stations for 3.9-mc. 'phone Trunk Line. K9EZX is  
after WAC on 7 mc. St. L. A.R.F.: New officers: W9GUQ,  
pres.; LTH, vice-pres.; GTK, secy.; LLN, treas.; NBV  
sgt.-at-arms. W9NNF and ILL are on 56 mc. W9FAB  
going into Service game. W9KIK is new member of  
A.R.F. The Hyde Park Radio Club organizes and reports  
for first time. Officers: W9HEL, pres.; LIT, vice-pres.;  
AAH, secy.; KEL, treas. W9OUA has new SW3. W9KEI  
puts 400 watts into 211s. Independents: W9HWE grinds  
FB crystals. W9HWD tried flea power 'phone on 3.5 mc.  
W9FIS is a married man. W9BHI has '52 final. W9NGS  
uses flea power. W9LWG bought 250-wattor from NDR.  
W9AAN is back after trip in south. Kansas City: W9RR  
reports U.S.N.R. traffic stations: W9RR, ZZ, CFL, and  
NP. W9AQX and LGZ conduct Missouri Drills. W9PPA  
was commended for work in aiding two lost Army planes  
land safely. The H.A.R.C. held first annual banquet  
Friday, Mar. 23rd. W9FNO, NFQ, HON, JOS, LBB, FEV,  
BMA, CVP, and KEP get in traffic for H.A.R.C. W9KTC  
has parasitic trouble. W9EQC has Super converter.  
W9MRM put pair of '52s on 1.75-mc. 'phone. W9CU puts  
100-watt c.c. job on 7 mc. W9DPJ is rewinding trans-  
former. W9KNH has low-power 14-mc. 'phone. W9LWO  
is on 3.9- and 14-mc. 'phone. W9PIJ is an old-timer.  
W9AEQ is on 14-mc. 'phone. W9LD is on 3.9-mc. 'phone.  
W9AIW, KGX and LGX have Class A exams under the  
belt. W9EPV works at KFRU. St. Joseph: W9IAC is  
printing QSLs. W9JCG and IAL live just one block from  
each other, but didn't know it for a year! W9NIS works  
DX on 1.7-mc. 'phone. W9MND worked a K5 and Mexi-  
can with 5 watts on 14 mc. W9DWF quit the game; he  
was active since 1911! W9KVB is on 14 mc. W9XJ operates  
portable 1.7-mc. 'phone. W9BWX comes through with a  
report. W9JXG moved to Savannah. W9OUW reported  
that OFB and LXX got married. W9CHE, CJL, OCZ,  
and CGA stick to 'phone. W9PBZ is a 13-year-old ham.  
W9ORS is at Dois, Mo., CCC Camp. W9CTG is QRL  
KFEQ. W9KEJ moved to North Platte. Independence:  
W9FQX is coming on with c.c. W9HRG is active on 14  
mc. W9HRX promises to be on by April 1st! W9JWI  
wants traffic schedules! W9MNH tries 1000 volts on a  
pair of '10s. W9NAQ made a rack around the old rig.  
W9NMC is proud of new SW45. Sedalia: W9AWC, HUN  
and AZL are working the rigs over. W9BTD attends  
school at Fulton. W9PVV is Sedalia's newest ham. Cen-  
tral College Radio Club, W9OECQ, wants more schedules.  
Reports by radio from W9KCC joins A.A.R.S.; DIC  
builds new antenna; NNZ is building tri-tet; FJV is try-  
ing 14 mc.; AHH reports HWV not in Parkville but active  
only on W9RAY, a new station; AIJ is still crippled, but  
recovering. W9OSL, KUT, KVN, get ORS appointment.  
W9JMH, OYS, LBA, use flea power on 14 mc. Southwest  
Missouri: W9MZD holds 13 schedules. W9CJR and ENF  
lead the district in traffic. W9ASV gets 18 countries, all  
continents, in contest! W9LXO, EHS, and FYU are reor-  
ganizing the Monett gang. W9IMZ reports hamfest at  
Mt. Grove with PTK, CXB, IGX, JXT, and 7QO pres-  
ent. W9MLR reports 9JSJ won out as Missouri Valley  
Wrestler. W9DFU has 211. W9LBM is trying 1.7-mc.  
'phone. W9OMG is in Jefferson City. W9EDK trying  
contest. W9DHN says W.U. op at Columbia is Ex-9ECS  
of Sikeston. New Missouri hams: W9PYD, GIN (from

ILL.), PTV, PWV, OVO, PSM, RDF. Rebuilders: W9DHF, DLB, BBK, JEH, MKT, GQY. Working DX: W9BZN, HVN, NDC. 166 reports this time, 55 with traffic!

Traffic: W9MZD 1365 JWI 317 HUZ 268 CJR 264 ASV 263 AIJ 261 NNZ 223 IXO 220 ENF 168 NP 123 KEP 98 BMA 91 NQA 49 RR 38 HUG 37 MKT 33 DIC 44 KVN 32 FJV-NFQ 30 KUT 18 AHH-CFL-ZK 17 EFC-FHV-JPT 14 LBA-HRG-BGE 12 JBV 10 BZN 9 JMM-KCG-EHS 8 HNM-OSL 7 OEQ 6 EZX 7 OVO-FYM-AUC 6 NMC-DLC 5 OYS-PSM-BBK-FNO-NGS-EYG-IMZ-4 ZZ-MLR 2 JOS-CU 1.

NEBRASKA—SCM, S. C. Wallace, W9FAM—W9DFE leads the Section! W9FYP is our own Official Phone Station. W9JED is handling a lot of 'phone traffic. W9OPP is new ORS. W9EWO is grinding crystals. W9IFZ is getting ready for N.G. Camp. W9DGL is official DX Champ of Nebraska. W9EEW says lots QRM between him and W9EYE. W9FWW is going c.c. W9DI is back in school. W9DEP is experimenting. W9IFE cancelled most schedules. W9KXQ will be on with more power. W9GKZ is set up YMCA, Lincoln. W9KPA is getting rebuilding fever. W9PDH reports from Rochester, Minn.

Traffic: W9DFE 627 FYP 202 JED 79 OPP 50 EWO-FAM 22 DGL 8 EEW 6 FWW 4 DHO 15 DEP 2 IFE 452 GKZ 34 CUY 188 KPA 81.

#### NEW ENGLAND DIVISION

CONNECTICUT—SCM, Fred A. Ellis, Jr., W1CTI—W1AMG, FIO and MK make BPL. W1DOW wins CBA's traffic banner for the month. W1DGG made 2147 points in DX Contest. W1GTW—QRL school. W1GKM reports for HAG and HJW. W1BQS uses transceiver on 56 mc. W1BNP and EWD had apparatus trouble. W1GXT is on 1.7-mc. 'phone. W1BIC was reported QSA5 R6 at VK4LS on 3.9-mc. 'phone. W1BFS has a cold shack. W1EFW reports a fixed 56-mc. station will appear on West Peak, near Meriden.

#### CONNECTICUT C B A Traffic Banner

The Connecticut Brass Pounders Association, W1CBA, awards a traffic banner to the Conn. station handling most traffic each month. It is transferred to the new winner each month. Designed by W1AMG, RM, it is 18 by 24 inches, gold letters and blue background (Conn. state colors).

Traffic: W1AMG 553 FIO 508 MK 300 BDI 201 UE 157 DOW 146 CJD 137 GGX 128 CTI 97 APW 78 GME 62 TD 28 YU 12 BHM 13 HSU-DGG 8 BWM 9 ES-GTW 6 FXQ 7 BNB 4 GKM 10 HAG-HJW 1 APZ 10.

MAINE—SCM, John W. Singleton, W1CDX—Fellows, the Maine Section has been saddened. We have suffered the loss of the best amateur any section ever had, Kenneth V. White, W1BOF who passed on to the greater life on March 18, 1934. We had all learned to love "Ken" as a brother; it is useless for us to try to say in words how deeply we feel our loss. Ken's entire time was devoted to putting his beloved Maine Section on top. Even during his time in the hospital he was busy planning for the betterment of the Maine Section. To Mrs. White and Virginia we express our deepest heart-felt sympathy. We can't ever expect to replace our loss, but we can try to keep "Ken's" Section on top, as we know "Ken" would have us do.

Traffic: W1GKC 209 BTG 97 EBM 93 CHF 88 CDX 75 US 67 ABQ 77 ERB 57 FJP 24 DHH 21 BTA 28 AQW 27 BNC 3 FXA-HUX 2 GBM 17 EF 138.

EASTERN MASSACHUSETTS—SCM, Joseph A. Mullen, W1ASI—W1ABG is rebuilding. W1WV is only on week-ends. W1ASI is on a bit with a '10. W1BMW's doublet mast blew down. W1DFS urges Navy Net men to report traffic. W1RE is handling Norfolk county on new net. W1VS has new Hammarlund Pro. W1BZO is building rack outfit. W1FRO keeps daily schedule with 3DXQ. W1GNA has been DX-ing. W1GCL is now ORS.

W1CRA is increasing power to 400 watts. W1AZF is on 1.7 mc. W1EHY has an 830. W1DNF is going FB on 3.9-mc. 'phone. W1CIR and DEK are on 56 mc. W1HJE is pushing a pair of 45s. W1FPO now has tri-tet. W1EVE is looking for Vt. and R. I. schedules. W1EHJ confines his traffic to Navy Net work. W1DWF is putting up a 1.7-mc. matched impedance antenna. The Eastern Mass. county net is now in operation. Make a schedule with your county station for rapid traffic moving. W1BFR has been on 3.5 mc.

Traffic: W1VS 556 CRA 203 FRO 154 EVJ 69 GCL 64 EVE 51 BZO 36 FPO 34 ABG 33 DFS-BMW-BFR 26 REF 23 RE-EHJ 22 AZF 10 ASI-HKY 8 WV 3.

WESTERN MASSACHUSETTS—SCM, Earl G. Hewinson, W1ASY-RB—W1BVR, chief RM, knocked off the largest total in our history! W1APL has a sore arm from writing letters on coming convention. W1GHU is RM for Worcester County. W1ZB ran an FB score in DX Contest. W1BNL uses new steel rack cabinet for transmitter. W1DUS swapped his old receiver for new pro! W1DUZ has Class B mod. W1BSJ is organizing 56-mc. net for A.A.R.S. W1EAX' antenna still flies after a hard winter. W1EOB is looking for morning schedules. W1EVZ finally QSO'ed his own city. W1DVW says W1VS sure cuts and dries his traffic. W1FNY has started on a traffic career. W1ASY is rebuilding three wires per day.

Traffic: W1BVR 408 FNY 141 DVW 122 HDH 106 EVZ 38 BKQ 39 GHU-EOB 36 OF 35 FAJ 33 ARH 27 BWY 25 EAX 19 DLH 12 BSJ 6 DUZ 5 DUS-APL 4 BNL 2 ZB 1.

NEW HAMPSHIRE—SCM, Basil F. Cutting, W1APK—The N. H. Section of A.R.R.L. celebrated 20th anniversary of the organization by having a hamfest in Manchester at Hotel Carpenter on April 7th. W1ERQ keeps schedules moving FB. W1CMB is an old-timer. W1DUB is putting thru traffic. W1FFL schedules W1FPX, AP and FCI. W1BJF schedules W1CCM. W1DMD worked 5 continents. W1GKE worked K6IDK on 7 mc. W1DMI reports an FB radio club by the name of Twin State Radio Club. W1CCM is doing wonderful work for Sanatorium. W1GEY is QRL Army radio. W1AGO has new Class B modulator. W1BEJ and AGO want same freq. W1HQE is going on 56 mc. W1GHT is building MOPA. W1BEO sends FB report from Berlin. W1UON pounds out WX reports daily. W1EZZ has new Ross receiver. W1FCI reports trouble with tubes. W1SK pulls teeth day times. W1BRT and HTO are on 14 mc. W1DUK is a radio service man. The Associated Radio Amateurs changed their name to Great Bay Radio Assn. W1AQX is building tri-tet. W1FFZ is building new c.c. March QST. W1EWF received QSLs from VK3KX and EI8B. W1ET of Dartmouth College is on 'phone, contacting W1BPI on Mt. Washington on 28 mc. W1ET's regular waves are: 3978, 3620, 7106, 14,212, and 28,960 kc. W1AVL did good work in SS. W1EAW has new speech amp. W1HPM is operating remote control over W1BDN. New OPS in N. H. is W1BDN. W1BII, FTJ and AVJ are rebuilding. W1EHO is c.c. W1AVJ has pair of '04s in linear P.P. W1BCP has a loud 3.9-mc. 'phone. W1ANS is getting fishing fever. The SCM is going to visit all N. H. hams this summer if possible. W1HOV is trying all bands.

Traffic: W1ERQ 455 GPN 163 FFL 206 UN 83 FCI 72 DMD 46 DMI 41 EZT 17 SK 15 FFF 11 BEO 13 GHT 10 CCM 7 APK 43.

RHODE ISLAND—SCM, Albert J. King, W1QR—W1GTN reports tri-tet perking FB. W1DDY is busy as RM. W1ERC is new ORS. W1BOY is A.A.R.S. NCS. W1QR is building new rig.

Traffic: W1DDY 41 QR 38 GTN 8.

VERMONT—SCM, Harry Page, W1ATF—W1FPS is new OPS. W1HLH applies for OPS. W1AXN has new "Jr. op." W1GNE and GGT are QRL school. W1GAE is completing c.c. rig. Vt. RM W1BUP secured data from all ORS and OPS regarding schedules, etc. Suggestions for improvement of amateur activity in Vt. addressed to him or the SCM will receive prompt attention.

Traffic: W1ATF 91 DQK 73 AXN 74 BD 65 BJP 60 GAE 7 GNF 8 AZV 5 HLH 18.

### NORTHWESTERN DIVISION

**ALASKA**—SCM, Richard J. Fox, K7PQ—K7GHP has crystal Comet Pro. K7FF has pair of '10s. K7BOE's total was boosted by Dan Cupid. K7VH is kicking his antenna thru the impedance matching device described in QST. K7EBR is the only contact with civilization for Cape Pole.

Traffic: K7AIB 6 BZX 7 EBR 20 FF 34 CPH 79 PQ 108 BOE 130.

**IDAHO**—SCM, Don Oberbillig, W7AVP—W7CRG reports new Silver super. W7CGU works DX in "wee sma' hours." W7AHS is hi-speed up at WUBJ. W7HK is on 14 mc. W7DMT schedules W7KI. W7ATN has 55-foot masts. W7CHT rebuilt for tri-tet. W7DBP has e.c. freq. meter. W7CX spent week-end with W7BCU. W7CG is in Boise. W7DBH has sound proof room. W7EFB won prize at radio club. W7AIS is in California. SCM would like to hear from W7JY, AT, AVR, AFT, CNA, and Moscow stations. W7ASA reports c.e. soon. W7BMF makes BPL. W7BRU works ZLs. W7DEQ and W7EAY are on debate team. W7DKY has new SW3. W7ACP buys Ford. W7BRY is flying. W7BAR is building super. W7KJ schedules Hollywood. W7EES was BC remote operator at YL style show. W7EEZ has new power supply. W7EFR is talking 1.7-mc. 'phone. W7CZO is QRL paint shop. W7CSP is installing c.e. W7CKO can work 5 bands with new rig. W7EDD uses c.e. W7BDY uses M.G. supply. W7EEW is new ham. W7CSW uses dynamotor for power. W7NH is Idaho's first YL ORS. W7BYW is fishing for DX. W7BLT has YLitis. W7DEB blew family "jools" for new car. W7EFL works DK. W7CFX is rebuilding. W7DD is QRL BC station. W7BAA has FB schedules.

Traffic: W7BMF 363 DSL 39 ASA 5 NH 19 CHT 20 AAJ 15 CSW 5 AVP 493.

**MONTANA**—SCM, O. W. Viers, W7AAT—W7BJZ is new O.O. W7CCR has 'phone perking. W7CREH drops all but Army schedules. W7AFS has four-stage rig. W7COX has new '66s. W7CEG is on 3553 kc. W7DXR has new buffer-doubler. W7DTC and BXZ rebuilt. New stations: W7EFO, EAL, EEL. W7CDG is on 1.7-mc. 'phone. On 3.5 mc.: W7CDZ, AAT. W7BVE heard report from KA1HR. W7EEH is on 7 mc. W7EAG wants L.A. schedules. W7BVI works ZL. W7CNE has P.P. '52s final. W7BZA is rag-chewing champ. W7AQN has pair 830's. W7APM schedules W6DPJ. How does your ORS stand, OMs?

Traffic: W7CCR 169 BJZ 33 AOD 36 BDJ 53 BYR 19 CRH 57 DXR 6 AAT 35 BDS 10 EEI 8. (Jan.-Feb. W7BVE 177 ASQ 61.)

**OREGON**—SCM, Raymond W. Cummins, W7ABZ—Outstanding stations: W7AYV, HD, and CXK. New reporters: W7EGX and DMS. Rebuilding and adding equipment: W7AMP, BEE, BDN, MQ, QY, LI, CIK, DEZ, and COQ. W7KR and BDN are hanging up DX. W7KH, RE, and BWD are experimenting. Following helped Oregon by sending traffic reports: W7DP, ALM, AXO, BBO, BDR, BOO, EBQ, DXC, BXQ, COU, CBA, CFM, BKL, BNK, BMA, WR, CVL, AIG, CHB, BNX, DEA, CTR, and DVX. New crystal at W7LT. Following phones active and reported: W7QP, AHZ, BKD, CTL, BUF, DKI, and BEK. Coos Bay Club elected officers as follows: pres., W7WL; vice-pres., CWH; secy.-treas., CRK. W7BLN returns from trip to Frisco. W7CUV is leaving to live in Calif. W7MFM moved to Grants Pass. The SCM is going on 1.7-mc. 'phone. Don't forget the 56-mc. field days, July 14th and 15th.

Traffic: W7AYV 859 CXK 307 HD 207 WR 110 AIG 30 BKL 78 CUV-ECO 47 CVL 41 DP 34 MF 35 CFM 32 CIK 30 BNK 25 BWD 23 BOO 25 BLN 22 AMF 17 COU 16 AHZ 18 DVX 14 BUF 12 DXC 13 ABZ 10 CTL 5 BKD-EBQ 4 LT 8 BMA-DKI-ALM 4 CRA-BXQ-BDR-AXO 2 BBO-QY-DEZ-CHB-CTR-DEA 1 BXU 8.

**WASHINGTON**—SCM, Stanley J. Belliveau, W7AYO—W7WY is teaching YL the code. W7CGI is new reporter. W7CZY is new RM. Reported by radio—W7DJJ, DPU, BBB, CZY, AWF, LD, DET, AWJ. W7DPU reports EGW a new ham. W7LD gets lots of traffic from U. of W. W7AWF is new ORS. W7DHR was elected

"chief sheik" at Roosevelt Hi in Seattle. W7JF will be on 7 and 14 mc. as portable at Tyce, Alaska, from April to Sept. W7DET is QRL track training. W7APR got married. Congrats. W7AGE applies for ORS. W7ECY is going on 'phone. W7AHQ is lining up K7 schedules. W7DGY gets out fine on 7 mc. W7BST is building MOPA. W7ALH ordered a suit by radio—hope it fits! Oak Harbor Radio Club is active with 13 members. W7AZI has new receiver. W7EHD is new Pullman ham. W7DRD is getting new c.e. rig. W7DRK has antenna troubles. W7AWJ and IG are QRL A.A.R.S. W7DRY keeps the way to Spokane open. W7DGN reports for EEJ and EAU. W7AVM clicked his first "J." W7CQI schedules APS. W7DNL clicks ZL on 3.5 mc. Your SCM clicked Handy, W1BDI, on prearranged schedule for a good hour rag chew. W7BUX is rebuilding. W7AEX clicked his first K6. W7AUP clicked VK. W7BCS has 50-watt MOPA.

Traffic: W7ABY 684 LD 369 DNL 282 AYO 248 AWF 216 WY 180 ABU 91 DGN 89 BHH 74 DRT 58 APS 53 CQI 50 DPU-IG 49 AGE 36 AHQ 31 BBB 27 AWJ 25 DJJ 21 AQ 18 CGI 16 EGY 12 BST-AZI 10 BBK 9 DRD 8 CQK 7 DET 6 DRK-DLN-EAU 5 AEX 4 EEJ-DGY-AVM-BUX 3 ECM-BCS-AUP 2.

### PACIFIC DIVISION

**HAWAII**—SCM, C. D. Slaten, K6CQG—K6CRU has three-stage c.c. job. K6JRN and JPQ pound brass like veterans. New hams: K6KCK, KFO, HQO. WVQB (K6EWQ) sends code practice Sunday nights on Army Net frequency 6990 kc. K6AGI has new junior op. Congrats, OM! This is last Section report from your outgoing SCM. Let's give the new one plenty of cooperation and a welcoming hand.

Traffic: K6EWQ 1883 JPT 448 GZI 99 CIB 24 GQF 20 COG 13 CRU 11 EDH 5 HOO 3.

**NEVADA**—SCM, Keston L. Ramsay, W6EAD—This report written by W6AJP. W6BYR is rebuilding. W6AAX is new DNCS for A.A.R.S. W6HGL, IKJ, AJP, GYX and UO are active A.A.R.S. W6AAX, BTJ, GFT, DSD, GUR, KGS, JVE, PKY, IEN and AJP are active U.S.N.R. W6DSD is only station at Mina. W6EAD's YF gives messages for her OM to W6AJP, who sends them "blind" to EAD three times weekly. W6EAD is working in eastern part of the state. W6BIC is experimenting with antenna coupling systems and angle radiation. W6UO has passed some of his work over to his son, GYX. W6JVH, JYA, KGS and KBS are newly licensed men.

Traffic: W6AJP 36 AAX 26 FUU 12 HGL 6 UO 18 GYX 10.

**LOS ANGELES**—Acting SCM, Howell C. Brown, W6BPU—The whole Section mourns the fact that our SCM, W6AAN, feels he can no longer keep up the work and has resigned. W6ETL, GXM, NF, OUU and AZU make BPL Club News; New club at Santa Monica High School, W6FRX pres. The Federation staged a big Hidden Transmitter Hunt on March 25th and had a big time. DX: by March 15th W6AM had worked 60 foreigners in 19 countries in contest; FYT made a whale of a score; FXL worked 5 continents; AAK with 8 watts in contest worked a flock. New ORS: W6FYW, GEX. New receivers: W6CLY, DEP, DOK, HFG, HEG, IFC. Rebuilding: W6BKY, WT, GNZ, HEW, ANN, GEX, HTO. New rigs: W6DGE, HTL. Experimenting: W6FWT gets a 37 in ultra-audio circuit to 65 centimeters. A.A.R.S.: W6DNA is new Alt. DNCS for 7th Dist. W6HEM is new member 6th, and COF new member 8th. New hams: W6JXE, KHK, KHN, JQL. New QRA: W6BMN, GKC, HWM, IGO and TN. W6TE is QRL ship operator. Ex-W5DHM will soon be on. W6ETL has FB outlet for Byrd traffic through WLM, who schedules daily. W6FNP joined Navy. W6IIA tried 'phone. W6NFI is op for Goodyear Zepp. W6LN made his 5000th QSO. W6IVU won SW3 at Glendale Club on a ten-cent ticket. W6KBG rebuilt to P.P. '10s. W6HTO reports for Ojai. W6BFL says noiseless mill FB for shack. W6GXM has to QTA schedules account study for promotional exam.

Traffic: W6ETL 1464 GXM 1007 NF 550 OUU 529 AZU 327 EDW 276 GNM 260 BPU 178 ETJ 176 AM 102

WCE 101 HFG 58 LN 52 FGT 51 GTE 44 EQW 43 GFG 42 DEP 36 AKW 44 JGA 33 DJC 31 EGG 30 DJS-JWL 24 EUV 22 KBY 21 FUE 19 HWM-TN 17 DZR-JWY-AIF-DNA 16 DOP-HID-IOX-DQZ 15 FYW 14 DWP-FYT 13 HHJ-GJA 12 EXQ 11 CLY-KID-HZJ-DYQ-IRD-CPM 10 DCJ-GLZ-GMA-BKY 9 BPM-JXZ-HEM-BPM-TE-HOP 8 BFL-DVV-HDC-GWO-BVZ 7 ANN-DGH-AAK-ERT-JSZ-COF 6 HWJ-FXF-LC-IFJ-JQS-JGU 5 CAH-EIU-HZM-CVV-AGF-HTL 4 IRA-KA-PD-BPP-BQF-ILA-HHG 3 IAR-FXL-IJV-ELV-FJK-GNZ-JZS-JFS-KBB-ALR 2 JYS-JOJ-IWC-JEX-IZX-DUX-IZF-BMN-ITK-VO-EK-INC-KEY-HT-JNE-KGV 1 KBG 5 BZF 123.

SANTA CLARA VALLEY—Acting SCM, Fred Stone, W6AOF—W6JCW, HZW, and CSI took Class A exam. W6BMW now has more time for radio. W6JCZ has new rig on 3.5 mc. Hollister reports new radio club. W6CEH works YLs and Ex.-YLs exclusively on new hi-power 'phone. W6DDS is president of Grippers Club. W6AMM had visit from KA1SL, W6LXJ and QR are rebuilding. W6AOF tries DX on 1.75-mc. 'phone. W6BSO has antenna trouble.

Traffic: W6BMW 46 JCZ 31 QR 22 JUQ 13 AOF 8 AMM 5 BSO 3.

EAST BAY—SCM, P. W. Dann, W6ZX—Thanks to all who helped the SCM in the ORS Transcons. W6DHS got most of the Transcons going, and hooked a couple in return. W6RF and JO helped plenty, too. W6CIZ, O.O., changed QRA. W6RJ, IY, and FII are QRL Army Net. W6FJQ and ATJ are new members of NCR. W6BPC and BFL visited the SCM. W6FS' ops license expired. W6GYA installed c.c. for his 1.75-mc. 'phone. W6APB completely rebuilt. W6JNX gets out FB with '45s. W6CAN has joined the ranks of the benedictines. Congrats. W6AUT and BPC visited the Napa gang. W6HRN is QRL school. W6HRG and FKQ have new rigs. W6IEW is on 14 and 7 mc. W6YJ, Oakland Tech. High, is on again. W6CZQ is now owner of a Hupmobile.

Traffic: W6RJ 257 GHD 229 RF 128 ZX 122 AKB 113 EJA 77 EDO 66 IY 64 CIZ 14 YM 54 DHS 25 DKJ 8.

SAN FRANCISCO—SCM, Byron Goodman, W6CAL—W6ZG BPLs, and added another op to relieve the strain. W6NK reports heavy U.S.N.R. drill schedule. W6WF has nice total. Tri-tet is answer to ham's prayer, says W6JMR. Welcome to ORS ranks, W6HIR. First K6 for W6JPA. W6HJP is thinking about ORS. Split-stator final works fine for W6GIS. W6GKO had new c.c. rig in tests. W6AZK is busy with OBCs. W6DDO and RM W6JAL sport new receivers. W6HSA claims JQZ can build rack and panel job in 30 minutes!. W6BVL is back after traffic. W6REI, MV, CIS were in DX tests. W6SG uses all bands. W6JVU heard D4LAA on 3.5 mc.! New c.c. rig for W6FVJ. W6ATP will soon be an Admiral, hints HZP W6JGV likes c.c. W6HPY has 830 final. First VK for W6UL. W6HFR has new rig with 211. W6HRY moved QRA. W6CAL is walking on his heels. W6JDG uses remote control. W6ELF has gone to 1.7-mc. 'phone. Don't forget, gang, HAMFLASHES is sent free to all reporters, traffic or no.

Traffic: W6ZG 1974 JAL 175 NK 132 WF 67 JMR 53 HIR 41 JPA 36 WM 29 HJP 20 GIS-GKO 17 AZK-DDO 14 HSA 13 SG 10 BVL-RH 12 MV 10 JVU 9 FVJ 7 ATP-FAJ-JQV-HPY-UL 6 HFR-HRY 5 CAL 2 ELF-HZP 1 JDG 68.

SACRAMENTO VALLEY—SCM, George L. Woodington, W6DVE—W6GVM visited IMJ, IQH, IZE, and KCA. W6IQH worked a five-way QSO on 1.75-mc. 'phone with a 5, 3, 8, 6. W6GDJ has a '52. By the time this goes to press Johnnie Mayes (BYB) will have a ball and chain. Congrats. W6KBK and IVU are new hams. W6JPI is on 1.75-mc. 'phone. W6DVE helped FRP put up two 60-ft. antenna poles. W6GBB gets good reports from East. W6HVM worked first W2. W6DFT sticks to the old rig. W6KAQ signed with A.A.R.S. W6CRN is active. W6ISX added an amplifier to c.c. oscillator. W6HER is on 7 mc. W6AHN is working on a portable. W6FRP is new OBS.

Traffic: W6CGJ 23 GAC 19 EWB 18 DYF 7 GZY-DVE 5.

ARIZONA—SCM, Ernesto Mendoza, W6BJF-QC—

This report written by W6HEU; the SCM is on National Guard detail. The First Arizona Hamfest held in Phoenix, March 17th and 18th, was a huge success with an attendance of 142! Following attended the hamfest: W6EGI, JZQ, HVY, BRI, AWD, JIW, HKX, ALU, DSQ, IUY, DQZ, GFK, DUQ, FXK, FRW, EBP, JOW, GBN, ILL, JCS, ENJ, IQY, IZU, KJH, EKU, DFE, BQW, FGG, JJO, JHF, HBQ, ISO, HCX, FPF, JEM, FOH, IUQ, CVR, BLP, BYD, GGS, GJC, CVW, CKF, KGQ, KGL, EFC, JHV, GDD, JDO, DKF, KFC, JYQ, DPS, KKE, FZQ, HBR, HAX, IXC, KHK, GHC, FRK, GZU, JFO, HUZ, IAX, EL, JMS, JPH, HEU, IIF, ANO, DJH, AND, KIA, DUJ, DRE. California was well represented by W6EQM, GWX, FCE, EFD, FRW. W6BTZ was there from Mankato, Minn. W6KKE is the dad of DPS. W6HQG reports from Ajo. W6FOH acquired an OW. W6ZZBC also reduced the number of YLs. Congrats, folks! Nogales reports an active radio club. W6EL is operating the Radio School at Phoenix Transient Camp. Old W6BWS is now W8IRA-DMG at Cincinnati, Ohio. W6IIG won code contest at hamfest. W6BRI won a call book for rating the beginners' class in code at the 'fest, and also had the lucky number which won a Bug! W6GFK was toastmaster at hamfest banquet. W6GZU schedules W5ZM and W6GXM. W6BGN reports FB DX. W6KGQ and KGL are teaching Phoenix gang something about swapping. W6FKX' new rig was a sensation at hamfest. W6BLP tried his hand at being a "radio artist." W6FIP schedules ALU. ASWRC plans a monthly Arizona Bulletin. W6JYQ is getting MOPA on the air. W6DOW was last seen pushing a piano up the Apache Trail! W6CKF and DPS came home from L.A. for the hamfest. W6JTW is changing QRA. W6HAX at Cottonwood has a new rig. W6FZQ, a real C.W. ham, won "best mike voice" contest at hamfest! W6CQF reports from Tucson. W6JFO is on C.W. W6GGS, DKF, and DJH gave fine talks at hamfest. W6GJC is official carpenter for the ASWRC!

Traffic: W6QC 59 GFK 1 KGQ 4 GZU 70 GBN 90 KGL 6 HEU 37 IIG 127 ALU 900.

PHILIPPINES—SCM, Newton E. Thompson, KA1XA—KA1CO left for States March 8th for six months' vacation.

Traffic: KA1HR 1443 EE 522 CM 433 NA 384 LG 238 RC 107 FS 89 XA 55 CS 54. KA4SW 58 GR 22. KA9WX 85 EP 46.

SAN DIEGO—SCM, Harry Ambler, W6EOP—RMs W6FQU, W6QA, Phone RM W6IBK. W6BMC makes BPL as usual and reports trancon trunk line working fine. W6DQN also makes BPL. W6EFFK and BMC play checkers over the air between schedules. W6EPZ left for Norfolk, Va. W6UA leaves in June for college. W6BHF visited SCM. W6BLZ has new QRA. W6GTD moved to S.F. W6HQM is building c.c. W6BAM worked all continents and 16 countries. W6KBX says good-bye to 'Phone. W6EOP, FBF, HY, EOL, GCT, GWY, FQD, HAO and DNW met at W6AJM's place for an FB rag-chew and eats. W6HEX worked 22 countries in contest, while W6GTM worked 12.

Traffic: W6BMC 1055 DQN 656 FWJ 158 EFK 174 EPZ 170 FQP 86 BHF 65 AXN 12 BLZ 10 GTM 7 BAM 6 KBX-EOP 3.

SAN JOAQUIN VALLEY—SCM, G. H. Lavender, W6DZN—W6AGV keeps four traffic schedules. W6GFB is on 7 and 14 mc. W6FBQ joined NCR. W6CVL-WLWF is QRL A.A.R.S. schedules. W6FFU has new rig. W6AOZ has fun on 56 mc. W6GJO is QRL Jr. college. W6AME moved to Grass Valley. W6HIP has c.c. rig. W6FYN on 7 and 3.5 mc. W6EXH is QRL on the farm with 500 baby chicks. W6GEG has a swell sig. W6IKG says he is Section's busiest ham. W6DVI has new '52 c.c. W6FFP promises that the Pacific Division A.R.R.L. Convention to be held in Fresno, Nov. 10th and 11th, will be a super-convention! W6PYM is building a tri-tet. We welcome W6GUR, formerly of Reno, Nevada, to our Section. W6JFY and KLC are new 3.5-mc. stations. W6GXL says tri-tet is the berries. W6JSG is a wire op in daytime.

Traffic: W6AGV 140 CVL 90 FFU 70 FYN 39 AME-AOZ 24 EXH 17 IKG 15 DVI 11 DQV 10 GUR 8 FYM 5.

## ROANOKE DIVISION

**N**ORTH CAROLINA—SCM, G. H. Wright, Jr., W4AVT—The Winston-Salem gang, operating W4NC, showed its mettle in QRR work during recent sleet storm that took down practically all wires, blocking all communication away from Winston-Salem. W4NC's work through various other N.C. hams, especially the Charlotte gang, sure put a star in the crown of amateur radio in N.C. The Greensboro gang also stood by in complete readiness. The 3.9-mc. and 1.7-mc. 'phone nets are functioning very smoothly. Enthusiasm is high at monthly meetings of Central Carolina Amateur Radio Club. The two-day meeting in Charlotte, March 3rd-4th was a big success. W4EG reports that W4ABT is now alternate SNC, A.A.R.S. W4BHR, OG, and CAY were put out of commission due to sleet storm. W4RE and ALK want "N" calls for NCR. W4AOA uses 46's PP in final. W4BDU likes Tar Heel Ham. W4UB had 40 QSOs in one day. W4AHH handled traffic via 1.7-mc. 'phone from Pa. to Fla. and got answer back to sender in 45 minutes. W4AIS got his c.e.c. rig working. W4CDQ handles traffic via 1.7-mc. 'phone. W4CJP says Alamance Club going strong. W4NY is good 1.7-mc. 'phone. W4EC states that Wilmington Club house is completed. All W4MR's traffic was handled with T12WD. W4BKF worked first VK. W4CSO is amateur call of NEF. Active: W4GNV, BSS. W4CQC worked a K6. W4CAY QRL SPU Co. getting lines back after recent storm. W4BYA uses low-powered 1.7-mc. 'phone. W4DW, EG, RA, MR, BUE, and CCD were active in DX Contest. W8JXZ is permanently located in Winston-Salem. New hams: W4CRT, CTO. W4COK is building tri-tet. W4QI is building Class B amp. W4BYE is c.c. with 100 watts in pair of 10's. SUBSCRIBE TO THE "TAR HEEL HAM" AND ATTEND THE MONTHLY MEETINGS OF THE CENTRAL CAROLINA AMATEUR RADIO CLUB.

Traffic: W4NC 175 EG 158 BLN 150 DW 136 AHH 130 BRK 126 AIS 96 ALK 92 UB 63 BRT 55 AOA 48 CJP-BYA-AVT 46 BX 38 CGH 37 BST 35 BKS 30 BSS 21 ANU 18 MR 17 CDQ 16 NY 15 BHR 14 BDU 12 BLU 11 RE-BJV-ALD 7 EC-CSO 6 ATS-VW-JB 5 TP 3 AAH-BXF-CNV 2 QI-BYE 2 CLY-CQC-ZH-OG-CCF 1 BTC 125. W8JXZ 4.

VIRGINIA—SCM, R. N. Eubank, W3AAJ-WS—Important traffic: W3BAD, BXN, AHC, CYU, CCU, BDQ, (Death), DVO, CGU (QRR), 1.7-mc. 'phones: W3AHC, BIW, COJ, APU, BEB, CDW, 3MT, BLJ, 3.9-mc. 'phones: W3AHQ, ASK, BIG, CNY, GY, BSY, CZJ, AZU, AJA. DX: W1ZZC, 3BAD, ADD, AGY, AAF, ALF, AG, BTR, BSB, BWA, CFV, DEH, DSH, DZH, EAP, UVA, BIW, AAJ, DNR, BAI, CIJ, CWS. Experimenters: W3AGY, AEW, BXN, AKN, EAP, EGW, CEY, 3GY, DHW, LY, BNE, CZJ, BZE, AVR, BAG, EDG, DVO, DFU, BRE, 3MT, BPI, DXO, EBK. Good schedules: W3AAF, ALF, AHQ, BJX, CFV, CMJ, NT, GZ, UVA, GY, AHC, FE, CIJ, AUG, BLJ, CDW, BRY, FJ, CSL. Want schedules: W3ECQ, BJX, CMJ, 3GE, DPV (C. C. Camp), DNR, FE, DQD. New calls: W3ELD, ELA, EDJ, ELJ, EEN, ELB, 4BFK, 3ELC, EDG, EGQ, DPV (8DES). In DX Contest: W3DEH, AAJ, AII, BWA, CCU, AG, BAI, FJ, CWS. New transmitters: W3EHL, MQ, CNY, DSH, DZH, DPV, EAP, EGW, BIW, ELJ, 3WM, EAI. New antenna: W3CMJ, EGW, ELJ. Moved to: Halifax, N.S., W1ZZC; Ft. Defiance, W3DWE; Alhambra, W3CVG; Alexandria, W3COJ; Atlanta, W3DON; Tennessee, W3BPA; Sperryville, W3DPV-8DES. New freq. equipment: W3BAI, CPN, DUG. Hamfests: Lynchburg, March, Floating Club, Fine, 57. Northern Virginia Meet at Herndon, March 16th—Another April 12th—Richmond wants May 20th Floating Club Fest. W3DGT of Covington is forming new club. Peninsula Club has new officers. Virginia nets: W3CA's QRR RR Net; W3GY's 3.9-mc. OPS Net; W3AHC's 1.7-mc. 'phone Net; W3FJ's A.A.R.S. C.W. Net, 3770-3800 kc.; W3PJ's 2 p.m. C.W. Sunday Net. Monthly report cards and Va. Bulletin will be mailed any active Va. station. Card to SCM is all. Don't miss the Virginia Floating Club meets. Report ANY activity on 16th to SCM. N. Carolina serves notice to take our lead! W3AG has worked 84 countries. W3BWA

worked ZU1. W3DEH worked 40 countries this month. W3GZ has four operators. W3ELJ has Collins and FB7. W3BZE worked HC2HP. W3BAN OO'ed 97. W3FJ, BSY handled chess game. W3BAI is trying C-11ins ant. coupling. W3CDW works in band. W3CZX is Traffic Mgr. Roanoke.

Traffic: W3NT 143 AAJ 104 CMJ 101 APT 84 GZ 82 UVA 68 BXJ 55 DQB-EGD 51 OM 50 ALF 40 AHQ 37 CA 34 CXM 26 GY 22 AAF 19 CFV 18 AEW-BXN 17 CNY 14 BAD-DPV-ECQ 11 WM 10 AG 9 AGY 8 BIG 6 BWA 5 DEH 4 ADD-AKN-ASK-DRK-EGW 3 BSB-CLD-DSH 2 AOT-BTR-COO-EAP 1 GE 35 BSY 111 DNR 79 BAI 35 FE 22 DQD 14 APU 12 BDQ-DGT 6 CCU-CPN 4 CZJ 3 BZE-CIJ 2 BAN 1 AUG 75 EBD 12 BGS 7 BLJ 4 DON-DVO 3 AZU 2 MT 1 FJ 64 DCU 48 BRY 11 CWS 3 EBK 4 AJA 2 CDW 1 EEN 23 ZA 13 DW 6 CBY 10 NE 1 ABE 14 EDJ 3 DDG 26. W1ZZC 34.

WEST VIRGINIA—SCM, C. S. Hoffmann, Jr., W8HD—Tri-State Hamfest will be held by Ohio Valley A.R.C. in Wheeling, April 21st. W8HCL married! Moundsville hams formed Moundsville Amateur Radio Club with W8HBQ, pres.; LES, v.-pres.; LBI, secy.; Ben Forester, treas. W8HBQ, FUV (Ex.-8AQI), DPO, KJSJ, and JRL entered DX Contest. W8HWO moved to Chicago. PA0ID moved back to Holland, after living in Wheeling several years. W8JKG applies for ORS. W8EWM is trying impedance matching with antenna. W8CDE was heard by ZL2HR. W8ELJ plans hamfest for members of W. Va. Net. W8AKQ has new rig. W8KDP, new A.A.R.S., desires ORS. W8CHEM worked OA1B on 14-mc. 'phone. W8DMF purchased rig of W8LS. W8ILF and JZU are increasing power. W8HGA will call "CQ Asia" on 14,020 kc. (CC), and listen for Asiatic stations on following schedules, May 21st to May 25th: 7:30 to 8 a.m. (E.S.T.) and 1 to 1:30 p.m. E.S.T., daily. W8CFB and CSF will operate transmitters at Camp Kanawha, CCC. W8BDD rebuilt P.A. using '10s. W8JWL is building 1.7-mc. 'phone. W8KNG joined the Army. W8AWT graduated from U. of Mich. W8HSA and JRL work VK's and ZL's. The R.I. paid W8GAD a friendly visit. W8DPD is nominated oldest ham in the State by W8JM. W8JQU works 3.5-mc. 'phone. New ORS: W8KKG. W8AHF, OPS, handled 17 messages.

Traffic: W8EIK 352 HCL 226 GB 176 BDD 125 HD 85 ELJ-KKG 40 KWU 23 BOW 19 HUK-KDP 15 DMF 14 AKQ 10 ELO-EWM 5 FQB 3 CHM 2 JM 33 JRL-BOK 2 EP-ILY 1 AHF 17.

## ROCKY MOUNTAIN DIVISION

**U**TAH-WYOMING—Acting SCM, Arty W. Clark, W6GQC—W6FYR crashes BPL! W6DTB's first QSO on new rig was J2GX. W6GQC is on extra duty in flower garden. W6JYD's first QSO was W4BUP. W6DEM is coaching new enthusiast. W6GGA is doing splendid traffic work at CCC Camp in St. George. W6LWY is going on 3.5-mc. c.w. W6CRS has new Hudson sedan. W6LAN is second Utah YL op. New Utah calls: W6KED, KFW, KIL, W7AOU DX'd Egypt and Belgium. W7CDH and DCO are new reporters. W7COH hooked first ZL.

Traffic: W6FYR 662 GQC 517 GGA 111 DJF 63 AH 29 JVA 26 AFN 19 BSE 16 DEM 6 IWY-FYP 5 W7COH 91 AOU 18 CDH 5 DCO 2.

COLORADO—SCM, T. R. Becker, W9BTO—W9ESA moved station to the basement of his home. W9GBQ is back strong. W9BYK changed final to RK18. W9LYE acquired new rack. W9CJJ is using 50-wattors. W9FFY is Colo. champion DX station. W9HQV and DDF are rebuilding to '03As. W9GVN worked a couple of "Js." W9LYO wants ORS: W9AAB requests that any criticisms or ideas regarding conditions of this Section or the League be mailed to him immediately. W9CWK is being rebuilt by W9LYE. W9EJN is at Fitzsimons General Hospital for a short time. W9AUP passed Radio Telephone First. W9DNP is on 'phone. W9IKA is on 1.7 mc. W9EMU burned out Class "B" transformers. The Gresley gang visited Denver. W9JNV is still at Woodmen. W9ODF has three-stage transmitter. W9IPL blew HV transformer. W9HQT says Patterson PR10 is FB. W9HGL is on 7 mc. W9FYK is in California. W9HIR and NAK are on 3.9-mc.



'phone. W9YL and EYN are on 14-mc. 'phone. W9BYC is in Chicago with McMurdo Silver Co. W9PO is on 'phone. W9FQK uses tri-tet. W9HEM, PGS, PRF and RCX are new hams. W9NEY is on 56 mc. W9IRV worked two VKs. W9LLP is working in Denver. W9AZT is a portable in Phi Kappa Tau Frat House. W9PWU applies for OPS. W9GJQ hopes to go over the 1000 mark soon. W9ECY reports new typewriter. W9CDE has been on sick list. W9APZ is on with a 30 tube. W9EKQ is on 14 mc. The PPARA extends hearty congratulations to W9FXQ's new junior YL opp. W9NRZ is building Class A modulator. W9HDU, formerly of Popular Bluff, Mo., is now active in Colo. Springs. W9JCQ's new QRA is Pueblo. W9DNP gets two Gammatrans. W9LJF uses an RK18. W9EHC built Class B modulator.

Traffic: W9CDE 18 GJQ 685 ESA 1222 PGS 7 AZT 41 EYN 186 NRZ 4 LJF 8 EHC 10.

#### SOUTHEASTERN DIVISION

**ALABAMA**—SCM, L. D. Eilwell, W4KP—W4DD has highest traffic total. W4AAQ is back in B'ham. Lightning burned out the fifty at W4CHJ. W4CJG wants traffic. W4COU sends ORS papers. W4ASM finds time for 'phone rig. W4BJA and BOU visited SCM. W4BIT is QRL club duties. W4BZG works them right and left. W4AG is new O.O. W4BIW wants traffic schedules. W4GL sends beaucoup dope from his locality. W4CIQ gathers dope for Coast Guard. W4CRF is trying to get bugs out of power supply. W4OA uses condenser mike. W4NU is active A.A.R.S. W4AIH desires schedules with Montgomery. W4CMK is on Southern Emergency Net. The secretary for Mobile reports the panel for new club transmitter is a piece of walnut over 100 years old. W4CLQ is back home. W4CCP is always ready for any emergency. W4BSL is helping run the Gorgas steam power plant. W4BXA paid W4CIU a visit. W4BWG reports the gang going fine. W4BGO wants schedules on 7 mc. from Storm Lake, Iowa. W4BPT is on at Vredenburg CCC Camp.

Traffic: W4DD 353 BOU 222 CHJ 156 APU 95 GL 73 BJA 50 BIW 46 AIH 42 CIQ 37 COU 35 DS 32 BIT 21 AG 20 BZG 11 ASM-KP 10.

**EASTERN FLORIDA**—SCM, Ray Atkinson, W4NN—W4AJX worked 44 countries and W4NN 33 in DX Contest. W4AKJ ran up nice total. RM W4ALP expects to go 'phone. W4AIW and BNR put through some good traffic. DX men: W4UX, BGR, W4AZB and NN are working on speed boats. W4AGB works mostly on 14-mc. 'phone. The SCM had several visits from Mr. and Mrs. W4DU. W4HY is going to cut new antenna. W4AIJ completed a dandy 200-watt c.c. job. W4TK is on 7 mc. W4BUM, BWZ and ASR completed new shack. W4AII pounds brass on KIPJ, S.S. *West Chataha*; QRA, Lykes Bros., New Orleans. RM W4WS has done a good job with Fla. Traffic Net. The Central Florida Radio Club set up W4CLW at the Central Florida Exposition and led the Section. The following undertook the job of traffic handling: W4CLW, BOD, CRS, CAM, BGZ, CCI, AKV, AJG, BSW, ABG, W1EAS and W4ACZ. Officers of the club are: pres., W4CLW; v.-pres., W4ACZ (Meanie); secy., W4CCI (Artist); treas., W4ABG.

Traffic: W4CLW 192 NN 120 AKJ 104 WS 35 ALP 32 ASR 28 AGB 20 BNR 15 HY-AIW-TK 4.

**WESTERN FLORIDA**—SCM, Eddie Collins, W4MS—RMs W4ACB, W4AUW. W4BGA clicked Africa six times in month. W4BFD: QRL drug store. W4ASV has new MOPA. W4CSR is on at Warrington. W4CTA is our latest ham. W4CDE is now ORS. W4CSL lives near BGA. W4AQY was transferred to Bonifay. W4CRU has new "Comet Pro." W4AUW is looking for DX. W4AUV is now on 3.5 mc. W4BKD and CMB promise 3.9-mc. 'phone. W4BOW uses spark coil power supply. W4BPI is at U. of F. W4AXP is our most faithful reporter. W4KB puts out nicest 'phone sig. we've heard. W4QK says all his VE QSOs are with same VE4. W4QU uses '04A. W4QCP has receiver troubles. W4ACB is rebuilding from scratch. W4AUA has been transferred back from N.C. W4QR has a tri-tet. W4CDE has a homemade Super. Active: W4AQA, CLP, CQF, BMJ. W4AGS is going to add a '52. W4BSJ has pre-selector and crystal

added to FB7-A. W4COG worked an average of one country out of every 9 QSO's. Next HAMFEST will be held in Tallahassee this summer. Who is qualified to hold O.O. appointment? W4CMJ is going to take 'phone exam.

Traffic: W4KB 43 AGS 22 AUW 12 BFD 3 BGA 12 COG 18 AUW 2 QY 1 AXP 4 CDE 8 MS 11 BJS 12 CRU 19 ACB 2 QR 2 BKV 18.

**GEORGIA-SOUTH CAROLINA-CUBA-ISLE OF PINES-PORTO RICO-VIRGIN ISLANDS**—SCM, G. A. Love, W4UT. Asst. SCM Bannie Stewart, W4CE—W4KV (WLR) is new NCS A.A.R.S. W4TL is starting an amateur club in Gainesville. CM2WW was elected president of the Radio Club de Cuba. Congrats, OM. CM2LC has SW BC station, COC. CM2EI built a duplicate of a Collins 'phone rig. CM2RA, NA and AN have 14-mc. 'phones. W4UT won the crystal prize in Liar's Contest at meeting of A.R.C. W4AJI is on 14 mc. W4CIR, BQM, BCY, BNB, BWB and CE were visitors at banquet given by Palmetto A.R.C. W4ANK was in DX Contest. W4GB rebuilt his rig. W4CSV is a new station. W4CKA is building a tri-tet. W4BNN and BZX are on 1.75-mc. 'phone. W4CRV ops at WIS, Columbia. W4MN led the S.C. A.A.R.S. in Red Cross Roll. W4CWB worked 48 countries in DX Contest. W4AAY is new NCS for Ga. W4ATZ uses link coupling. W4AEI has Class B 'phone. W4BAB is trying tri-tet. Please send reports to 50 Muscogee Ave., Atlanta. SCM's new QRA.

Traffic: W4IR 798 KM 104 UT 27 ATZ 44 AJI 22 CIR 20 AAY-VX 18 CBY 16 RM 12 AEI 9 CE 8. CM2WW 6.

#### WEST GULF DIVISION

**NORTHERN TEXAS**—SCM, Glen E. Talbutt, W5AUL—W5BH, Chief RM; W5IA, W5ARS, W5BKH, Asst. RM's; W5BAY, 'Phone Activities Mgr. W5BII runs away from everybody with traffic. W5CPT is new ORS. W5BCW DX'ed 21 prefixes. W5CHJ sold his store. W5ATI gives us the "Mae West." W5DXA reports our old Pal "Phiv." W5DVV wants ORS. W5AW, DKF and AZB have new c.c. rigs. W5SP wants new receiver. W5CAM has a '52. W5DUR wants more QSOs with W5's. W5CPU worked first ZL. W5DYU and DMA report for first time. W5BTJ says no traffic on 1.75 mc. W5CTU is back with us. W5BXJ worked a "J." Following report traffic and activities: W5BKH, ANU, IA, CMS, CYU, AQS, CIJ, ARV, DQW, DMD, DQO, CJE, CAV, APW, AVA, BKC, IT, AUJ, DST, BAY, ARS, CXS and NW. Abilene Club's new officers: W5AUL, pres.; AW, vice-pres., and AZB, secy. W5BKJ says Ennis Club has good attendance. W5DAA reports Terrell Club getting many new members. Athens Club call is W5DWK; they have regular code class each Thurs. night. Wichita Falls is "hot" for 1935 Convention. W5NW is in charge of a drive for A.R.R.L. membership ending June 1st. He is candidate for Director. The Section bulletin is discontinued for several months. Please continue to report without being begged for it, OMs.

Traffic: W5BII 422 AW 127 ARS 116 CPB 109 CPT 76 BKH 62 ANU-AUL 42 IA 37 CMS 21 AZB 20 DKF 19 CYU-CHJ 18 AQS 14 CIJ 12 ATI 10 CXS 6 DXA 7 DQW-BXY-ARV 5 DMD-DQO 4 NW-DVV 2 DMA-CJE 1.

**OKLAHOMA**—SCM, Carter L. Simpson, W5CEZ—W5AKX, AJF, BAR, BCS, BDX, BJG, BQZ and DQV report via radio. W5CEZ again leads Section. W5AJF won first place in 8th C.A. and second in U.S. on A.A.R.S. ZAG Contest. W5AMC is building recording equipment. W9CLF moved to Boise City. W5BQZ tries for DX. W5BDX works VK's. W5ASQ is petty officer in charge of unit five U.S.N.R. at Ponca City. W5DZZ is new ham. W5BQI moves to Okla. City. W5BWN blew filter. W5CEB has tri-tet. W5CWL and CPC go c.c. W5ASW, ABK, BJT and BJK have FB7's. W5DRD is playing with 28 mc. W5BGX QRT fooling with 'phone. W5DQV and BKK join A.A.R.S. W5ABK is DNCS for Okla. A.A.R.S. 'phones. W5RF has new rig. We need more ORS! Let's have applications. Mail reports to SCM on 16th of each month. See page 5 this issue for QRA.

Traffic: W5CEZ 910 BQZ 156 AJF 127 BDX 81 ASQ 75 BAR 67 AKX 63 BWN 50 BJG 27 RF 14 AMS 19



AMC 11 DQV 9 BCS 5 CNC 103 CUX 9 AA 8 DDW 4.

**SOUTHERN TEXAS**—SCM, D. H. Calk, W5BHO—W5OW sends usual FB total. W5MN has four daily schedules. W5BFA handled two messages from "Little America." W5ADZ WAC'd in one week. W5BB reports activity in his neck of the woods. W5AFQ is moving away from a power leak. W5CVW installed new buffer. W5BEF and BWM-YL report. W5HX is on 14 mc. W5CT and GZ combined. W5AXY is building a 1-KW rig. W5CTW has about six hundred watts. W5BXH is building low-power rig. W5DGG is putting on 14-mc. 'phone. W5VV has been in Bermuda. W5DPA, Houston Amateur Radio Club, is now on 1.75 and 3.5 mc. The Bay City and Wharton gang held an FB hamfest at Wharton in March. W5BKW and ANW have portable 56-mc. transceivers working. W5DTT sends news from El Paso. W5NNT has new PR10. W5OYS has new FB7. W5DTM and DYM have c.c. rigs. W5DWC had 26 QSOs in one night. W5DXM has new rig. W5DE has C bias trouble. W5DWH is going to c.w. W5DUL has new power supply. W5AFN handles traffic. W5GI has new ticket. W5AEP has new recto-bulbs. El Paso Transmitting Society elected officers: W5AEC, pres.; W5AOT, vice-pres.; W5GI, secy.-treas.

Traffic: W5OW 2123 MN 467 BFA 41 BB 30 AFQ 24 BEF 22 ADZ 10 BHO 5 ON 2.

**NEW MEXICO**—SCM, Dan W. De Lay, W5DUI—Traffic honors again go to W5ZM. W5CGJ and BNT are next in line. W5AAX takes DX honors. W5AOP and CSR are building. W5ASR is on 14 mc. W5DZY is a new ham. W5BVC reports new rig. W5ND is in C.C. Camp in southeast part of state. W5DLG schedules ZM and DFG. W5CPO graduated from Naval Radio School, honor man of his class. Let's originate more traffic!

Traffic: W5ZM 201 CGJ 100 BNT 31 AAX 25 DUI 11 CSR 5.

## CANADA

### MARITIME DIVISION

**NOVA SCOTIA**—SCM, A. M. Crowell, VE1DQ—1GL is top traffic man. 1DQ had half-hour 14-mc. 'phone chat with ZS1H. 1DC visited his brother, 1GL. 1FB is busy dishing out QSLs. 1GT is Ex-2CD and 2AQ. 1GU is new Halifax ham. 1BC, AG, BW and BY are active on 3.9 mc. 1EA schedules 2BV weekly. 1EP, EA, ET, AS, DR, BR and DQ were active in DX Contest. 1BB has two transmitters (14 and 3.9 mc.); report via 1DO. 1EX and YF visited Halifax. 3.9-mc. 'phone men get in touch with 1AG, who is OPS and organizing net for emergency work. 1EK hooked a PAØ. 1DE is taking a swat at 14 mc. 1ET landed a comm. job with R.C.M.P.

Traffic: VE1GL 62 FN 14 DC 9 EA-FB 2.

### ONTARIO DIVISION

**ONTARIO**—SCM, S. B. Trainer, Jr., VE3GT—3WX again leads in traffic. 3DW, DX, FW, NM are going c.c. 300 has gone. 3JI and 3AL talk it over on 3.5-mc. 'phone. 3MX sends ØBC on 9750 kc. 6:30 p.m. Mon. and Thurs. 3DU, NO, and QK are new ORS. 3GI is new OO. 3WB, QD, EA, JA, JZ, NO, and MP were in DX tests. 3JT is hot after traffic. 3EU and LK contemplate 14-mc. 'phone. 3RK won Ottawa DX Contest. Central Tech. School station, 3ED, wishes to thank all who QSPed. 3TN reports traffic for first time. 3WC is trying to get his call changed! Active: 3NJ, YB, RQ, SE, PC, RE, GC, IV, EZ, KC, QC, WM, NI, UC. On 1.7 mc.: 3PT, PZ, TD, SP, MJ, OR. 3UY and KF are c.c. on 7 mc. Moving to 3.9-mc. 'phone: 3OF, JU, KM, RT. Rebuilding: 3HT, JY. Grinding crystals: 3FP, PG, TB. 3DC and AO are on 3.5 mc. 3VD has a neat layout. 3GX saw his shadow. Hamilton A.R.C. attendance is going up steadily. Grief at 3IE. 3UF has the bugs out at last. 3LN built a transceiver. 3RL likes new receiver. 3II, IX, and MP are on 3.9-mc. 'phone. 3CN and MP are on 14-mc. 'phone. 3PV wants a gentle bite from c.w. bug. 3UU likes new rig. 3WK and SG won first and second places in Ontario Contest. 9AL, 3GT, QK, JT, GR, IM, PN, and AZ are members of No. 10 Squadron (A. C.) Royal Canadian Air Force. 3QZ has gone to Toronto. 3VP won oratorical con-

test. 3VG has 400 volts of No. 6 dry cells. QSO between QL and "YL" is suggested. 3XO gives fine service on traffic. The new YF of 3GH let him on the air once more. 3EA pensioned the surviving '81. 3RA is trying to learn how to use crystal. 3CX broke his forcing it into too small a holder. 3GG, GW, and CH are on 3.5 mc. 3KN is afraid of BCLs. 3WH converted converter to receiver. 3GS likes 14-mc. vertical antenna. 3FQ is looking for "sticks." 3IP is servicing. 3GB has a midget on 14 mc.

Traffic: VE3JT 262 WX 461 DW 5 GT 369 UU 13 SG 49 WU 1 WB 12 TO 5 TG 3 TQ 8 HP 49 TM 149 ED 55 TN 7 RQ 4 QK 45 WK 77 GI 22 IB 40 IX 14 RT 1 LK 15 DJ 110 LZ 53 YE 2 QB 6 XK-VL 1 VD 12 MP 3 JI 157 GO 190 BZ 24 LA 86 RO 45 DU 2 HA 7 CX 81 NO 16 XO 30 SV 4 QJ 3 YL-GR 2 GH 4 RK 132 LI 36. VE9AL 22.

### QUEBEC DIVISION

**QUEBEC**—SCM, John C. Stadler, VE2AP—The South Shore Radio Club had fine hamfest with record attendance of over 100. 2HK has gone after traffic! 2BB worked VK on 7 mc. 2EE gets out well on 14-mc. 'phone. 2DW plans a 'phone station. 2CX is mostly on 'phone. 2CG sends first traffic report. Congrats to 2DG and GO, who finally landed VK. 2HE worked W7 on 1.7-mc. 'phone. 2HN has many local hams visiting him. 2AB is building high-power phone. 2IA is moving to summer QRA. 2GK is returning to his ship. 2DS is leaving for VE5. 2DR reports DX. 2DU has an FBX. 2AW is almost ready with c.c. 2DB quit ham radio on account ill health. 2HP is building new station. Welcome to 2IQ. Request your continued cooperation with Acting SCM 2GA. Thanks to all members for support while was able to hold office of SCM. Good luck to you all.—VE2AP.

Traffic: VE2HK 362 CX 132 BB 46 EE 15 CG 7 DG 13 AP 8.

### VANALTA DIVISION

**ALBERTA**—SCM, J. Smalley, Jr., VE4GD—4HM reports for Edmonton. 4PH and QX are active. 4GY is installing c.c. 4FR is on 14 mc. with P.P. '45s. 4EO reports for Lethbridge. 4EO is OBS. 4AF is becoming traffic-minded. 4OG is installing 211. Lethbridge A.R.C. is holding contest in May. 4JR visited Calgary. Active in Calgary: 4DX, HQ, GV, IQ, JK, LK, NC, LX, AX, AW, FG, NH, NJ, NQ, GY, KG, JX, QH, QG, PJ, MG, IW and GD. 4DX and AW tried 1.7-mc. 'phone. 4IQ rebuilt. 4JK is with CFCN. 4NC has tri-tet. 4MG is working at Johnston's Canyon. 4QH and QG are new stations. 4JX is chasing DX. 4NH is building MOPA. 4AX has rack and panel job. 4LX is at Rockyford. 4EA wins DX Contest. RM 4BZ and SCM are getting Alberta lined with networks. 4KG is becoming traffic hound. 4KN and LA are active at Rockyford. 4JJ gets out fine on 3.9-mc. 'phone. 4GK badly burned hands when his shack caught fire. 4FG causes lots of excitement among Calgary gang.

Traffic: VE4LX-BZ 48 KG 12 EO 11 QH 2 GD 1.

**BRITISH COLUMBIA**—SCM, R. K. Town, VE5AC—Several old-timers are back on the air: 5KV, ex-5CS of spark days; KD, ex-AE; KN, ex-EU and JR, ex-4FJ. Rebuilding: 5IO, JI, IM, BC. New receivers: 5IO, KD and AC. 5JA keeps 12 schedules a week. BC Net coming on slowly. More attendance makes a better party. Come and join us on 3.5 mc., Sunday, 10 a.m. 5EU has c.c. perking. 5IM is new ORS. 5KS sends code practice. 5BI, HQ, CA and EH were in DX Contest. 5DF is visitor to Vancouver. 5EE pops tubes. 5GG can't make dud tubes work.

Traffic: VE5AC 14 IM 42 JA 46 FG-AL 4 GI 6 EU 8 EO 3 KS-KU 31 CA 10 DD 5 HQ 3 KC 1 KK 2 CE 15 EE-JL 5 AG 18.

### PRAIRIE DIVISION

**MANITOBA**—SCM, Reg Strong, VE4GC—4MJ has an FB station. 4DU, MV, DJ, MY, FT, DK, LE, RO and GC work DX. 4RM and CD work 28 mc. Active stations: 4BG, DZ, KX, LL, LT, NT, NY and OB. 4KU schedules 5JQ. 4MW has final stage completed. The M.W.E.A. appreciates 4JF's activities in the past and wishes him luck in Vancouver.

Traffic: VE4MJ 7 KU 6 GC 5.

SASKATCHEWAN—SCM, Wilfred Skaife, VE4EL—Moose Jaw is having a hamfest on May 24th. A chance to look over the 'phone rigs of 4JU and FY, to see the keying tubes modulation of 4IG, and to examine the little DXer of 4KA. Don't miss it! 4BR likes c.c. reports. 4KV is doing fine. 4KJ is P.P. throughout. 4GA says c.e. rig FB. 4JV QSOed K6, X, ZL and VK in contest. 4EJ hooked ZL on low power. 4FD, EJ and GR had all night DX session. 4RI has receiver trouble. 4JU has fine 'phone. 4JS invented choke Kimona, and a few of the boys have joined the Mermaids. (Particulars upon application.) Your SCM visited Weyburn, Moose Jaw and Swift Current; had a nice 'phone QSO from 4ES with 4EU terminated by blowing '83. 4CV has nice rig. 4ND has P.P. final '10s. 4ML joined Benedicts. 4IG has been working real DX. 4AY uses pair of '45s PP-TNT.

Traffic: VE4MH 37 GA 22 CN 17 EL 15 GR 11 EU 6 EJ 10 KJ 3 MB 2 AY 4.

### A-1 Operator Club-QSO Party!

(For A-1 Operators Only)

May 19th, 5:00 p.m., to May 20th, 5:00 a.m. (local time).

Mark your calendar now—don't miss it!  
12 hours of real operating with real operators!  
A chance to QSO brother club members.

A real hammy fraternal spirit will prevail.

No scores—in informal QSO fest.

Call "CQ AI" to raise other members of the club.

Use list of members! Check those worked.

Report number of QSO's to A.R.R.L. HQs.

## A.R.R.L. A-1 Operator Club

THE A.R.R.L. A-1 Operator Club was organized in May, 1933, to promote and encourage a high calibre of operating in the amateur bands. The first list of members and announcement of the club appeared in July, 1933, *QST*. Membership has increased constantly until it now totals 404 of amateur radio's best operators.

It is not sufficient to be merely a "speed king" to rate membership among the "A-1 Operators"—a man must be an "all-round good operator" with consideration given to general keying, voice technique, procedure, copying ability, judgment and courtesy. The A-1 Operator Club is open to all active radio amateurs, both 'phone and c.w., in any country of the world. Operating qualifications alone are considered without regard to membership in A.R.R.L. or any other society.

Nomination by two operators who already "belong" is necessary before a man is admitted to membership. A complete and up-to-date list of A-1 Operator Club members is given here—nomination by any two of these operators will make you eligible for membership. The A-1 Operator Club should number in its ranks every amateur operator who lives up to a high standard of operating technique. "A-1" Club members are ever on the look-out for new members, so watch your operating at all times—aim to become an "A-1 Operator." Supplements to the membership roster appear in *QST* from time to time.

## A-1 OPERATORS

C.W.: W1AFB AGA AJB AJL AMG APR APW ARB ATJ BB BD BDI BEU BHM BLI BMP BOF BVP BYW BZI (Alma, Elaine, Helen & FS) CIX CFB CHF CJD CPT CRP CTI DDK DF DGG DKO EF EH ES EVJ FIO GC GOG IP SZ UE VB VS WV YU (Bob) ZB.

W2ACD AEN AEF AVF AGL AIQ AYN BCX BGO BJA BPY BZZ CO CWK DBQ DIU (EW) DRV EKM ETH KG LU LW SC UL WP.

W3AAJ ADE ADM AHD AKB AKN ALX AMR ARV ATJ ATY BAI BEY BJX BKQ (MW & BNS) BND BNH BWT (ED & CJ) BYA CAH CDG CFL CL CMJ COO CQS CTD CVU CXL (ED, CB, YB & White) CXM DD DEH DZ EF FJ GE GS LA MC MG NF (ED) NR NT (RC) OK OM QN QV SN (FX) WO WU ZD ZL.

W4ABT AFM AGR AJX ANZ AVT BOZ CE DW EC EG FT HA JR LL MO OI (Dave & Mac) PL TO ZH.

W5ATF AUL AVU BED BII BMI BTU CEZ EB OW (H) SI VQ ZC.

W6AAN AKW ALU AM AOR BJF BMC BSV CDA CGJ CKO CUH CUU CVL CXW DEP DPJ DVD ETL ETM HT MV OJ QA RJ SN UO WB ZG.

W7AAT ASQ AWH AXJ BAA BB CRH FL SO.

W8AJE AKV APC APQ ARX AVK BAH BAS BBH BGY BHK BJO BME BMG BMK BRC BTK CEO CEU CER CGS CLQ CMI CPE CQA CUG DEX DDS DEL DES (Hal) DLG DMJ DNX DSA DSS DVL DYH DZ EEZ EGI EIK ELJ EVC FCB FDY FFK FGV FLA FTW FX FYF BG GBB GBC GEG GOD GSO GUC GUF GUX GZ HD HGG HSH JE JM KD KKG KQQ KR PL PP QT VP YA (Geo. & Faries).

W9ABE ACL AET AMB AND APY AUH AZN BAN BAZ BBP BCX BKJ BKK BWF CDA CFL CGV CNE CRT CTP CYD DDE DFE DFF DGS DHA DI DMY DNU DOU DXY DZW/GP EEW EFC EGU EHW EIC ENH EPJ ERU ESA ESU EW EWO FA FAA FAM FFD FLG FO FP FQ FQG FRA FUW HML HSK HVA HYR ILH IYA JRK JZY KG KNZ OX PLM UZ VS YB (Booth/8DDF-PV).

K6AJA COG EWQ.

K7AOA PQ.

VE1ER 2BB 3AD AU CP GT HA 4BB DK 5HP.

Foreign: EA1AS 4AO 4BE G2BM (H & R) 5YH PA0QQ.

Phone: W1AQM AUJ AVK CCZ SZ W2AWR BYM JN TP W3AER AVL AXT CNY DF DQ GY WX ZA W4OC TR W5AOT ZA W6CNE KT ZH W8AJ AOM CPC DLD RD W9CJJ DRD.

## 1934 Radio Pentathlon

The 1934 "Radio Pentathlon" (indoor track meet) between Palama Boys' Club of Honolulu and the San Francisco Playground teams was a bigger success than either of the two previous meets. Stations of the Associated Radio Amateurs of San Francisco handled the coast end. Schedules were arranged as follows: K6BAZ with W6MV; W6CIS with K6EWQ; W6NK with K6CIB (c.w.) and the Army Net from both cities.

W6MV won the Daniel Murphy loving cup for the best work in relaying messages. Working with K6BAZ on 7 mc. from 8 p.m. until 1:30 a.m. P.S.T., the scores of seventy-five events, with names, weights, etc., were relayed without a miss. Not a single error was made in handling over 3000 words!

As a special feature of the 1934 pentathlon Mayor Angelo Rossi of San Francisco and Mayor Wright of Honolulu held a 20-minute QSO over W6AWT and K6CIB on 3.9-mc. 'phone. W6AWT will be remembered by old-timers as winner of the Hoover Cup in 1924. W6ADA was in charge of radio arrangements for the pentathlon.

The "Radio Pentathlon" is one of the outstanding sports events on the Pacific coast and in Hawaii. In November or December of this year a similar meet will be held with Mexico.

—C. J. Vanoncini

## Section Communications Managers of the A.R.R.L. Communications Department

All appointments in the League's field organization are made by the proper S.C.M., elected by members in each Section listed. Mail your S.C.M. (on the 16th of each month) a postal covering your radio activities for the previous 30 days. Tell him your DX, plans for experimenting, results in 'phone and traffic. He is interested, whether you are an A.R.R.L. member or get your QST at the newsstands; he wants a report from every active ham. If interested and qualified for O.R.S., O.P.S. or other appointments he can tell you about them, too.

Eastern Pennsylvania Maryland-Delaware-District of Columbia Southern New Jersey Western New York Western Pennsylvania	W3GS W3BAK W3QI W8DSP W8CUG	<b>ATLANTIC DIVISION</b> Jack Wagenseller Edgar L. Hudson Gedney Rigor Don Farrell C. H. Grossarth	24 South Fairview Ave. 412 2nd Ave. 213 Hickok Ave. R. F. D. 3, Eicher Rd.	Highland Park, Upper Darby Laurel, Delaware Haddon Heights Syracuse Emsworth, Bellevue Pa.
Illinois Indiana Kentucky Michigan Ohio Wisconsin	W9WR W9TE W9OX W8DYH W8BAH W9FSS	<b>CENTRAL DIVISION</b> Fred J. Hinds Arthur L. Braun Carl L. Pfumm Kenneth F. Conroy Harry A. Tummonds Harold H. Kurth	6618 West 34th St. 911 Reisner St. P. O. Box 359 7538 E. Robinwood Ave. 2073 West 85th St. 2350 N. 8th St.	Berwyn Indianapolis Louisville Detroit Cleveland Milwaukee
North Dakota South Dakota* Northern Minnesota Southern Minnesota*	W9DGS-IFW W9AZR W9JIE W9DEI	<b>DAKOTA DIVISION</b> Wm. Langer Cecil E. Davis Robert C. Harshberger Francis C. Kramer	313 First Ave., S. 1200 Fauquier St. W. Bluff St.	Jamestown Tripp St. Paul St. Charles
Arkansas Louisiana Mississippi* Tennessee	W5ABI W5DWW W5VI W4AFM	<b>DELTA DIVISION</b> H. E. Velte W. J. Wilkinson, Jr. W. P. Allen F. F. Purdy	2918 West 15th St. 1624 Allen Ave. P. O. Box 66 P. O. Box 173	Little Rock Shreveport Jackson Kingsport
Eastern New York N. Y. C. & Long Island Northern New Jersey*	W2LU W2AZV W2BYP	<b>HUDSON DIVISION</b> Robert E. Haight E. L. Baumach Robert Maloney	1080 Helderberg Ave. 7823 10th Ave. 315 Watson Ave.	Schenectady Brooklyn Perth Amboy
Iowa Kansas Missouri Nebraska	W9FRD W9FLG W9EYG-JPT W9FAM	<b>MIDWEST DIVISION</b> George D. Hansen O. J. Spetter C. R. Cannady Samuel C. Wallace	3734 Summit St. 305 Western Ave. 300 Sixth St. Green St.	Sloux City Topeka Monett Clarks
Connecticut Maine Eastern Massachusetts Western Massachusetts New Hampshire Rhode Island Vermont	W1CTI W1CDX W1ASI W1ASV-W1RB W1APK W1QR W1ATF	<b>NEW ENGLAND DIVISION</b> Frederick Ellis, Jr. John W. Singleton Joseph A. Mullen Earl G. Hewinson Basil Cutting Albert J. King Harry Page	19 Merrill Rd. 10 High Street 16 Mercier Ave. 33 Cortland St. 66 Lisbon St. R. 1	Norwalk Wilton Ashmont Springfield Fenbrook Providence Hinesburg
Alaska Idaho Montana Oregon Washington	K7PQ W7AVP W7AAT-7QT W7ABZ W7AYO	<b>NORTHWESTERN DIVISION</b> Richard J. Fox Don D. Oberbillig O. W. Viers Raymond W. Cummins Stanley J. Belliveau	Box 301 P. O. Box 1271 4835 N. Amherst St. Route 7, Box 387	Ketchikan Boise Red Lodge Portland Yakima
Hawaii Nevada Los Angeles* Santa Clara Valley* East Bay San Francisco Sacramento Valley Arizona Philippines San Diego San Joaquin Valley	K6CQG W6EAD W6BPU W6DBB W6ZX W6CAL W6DVE W6BIF-W6QC KA1XA W6EOP W6DZN	<b>PACIFIC DIVISION</b> C. D. Staten Keston L. Ramsay Howell C. Brown Barton A. Wood P. W. Dann Bryon Goodman Geo. L. Woodington Robert Mendoza Newton E. Thompson Harry A. Ambler G. H. Lavender	Pearl City 1151 Buena Vista Ave. 120 N. El Molino Ave. R. 1, Box 722 1821 Chestnut St. 141 Alton Ave. 716 Redwood Ave. 1434 East Madison St. 714 Tennessee 4101 Hamilton St. Route 6, Box 425	Oahu Reno Pasadena Campbell Berkeley San Francisco North Sacramento Phoenix Manila, P. I. San Diego Stockton
North Carolina Virginia West Virginia	W4AVT W3AAJ W8HD	<b>ROANOKE DIVISION</b> G. H. Wright, Jr. R. N. Eubank C. S. Hoffmann, Jr.	2817 Montrose Ave. 100 20th St.	Wendell Richmond Warwood, Wheeling
Colorado Utah-Wyoming*	W9BTO W6GQC-IDM	<b>ROCKY MOUNTAIN DIVISION</b> T. R. Becker Arty W. Clark	1176 Gaylord St. 260 So. 9th West	Denver Salt Lake City, Utah
Alabama Eastern Florida Western Florida Georgia-So. Carolina-Cuba- Isle-of-Pines-Porto Rico- Virgin Islands	W4KP W4NN W4MS W4UT	<b>SOUTHEASTERN DIVISION</b> L. D. Elwell Ray Atkinson Edward J. Collins George A. Love	1066 Waverly St. 4524 College St. 1517 East Brainard St. 50 Muscogee Ave.	Tarrant Jacksonville Pensacola Atlanta
Northern Texas Oklahoma Southern Texas New Mexico	W5AUL W5CEZ W5BHO W5DUI	<b>WEST GULF DIVISION</b> Glen E. Talbutt Carter L. Simpson David H. Calk Dan W. De Lay	1902 South 11th St. 2010 So. 4th St. 6726 Ave. Q 407 South Girard St.	Abilene Ponca City Houston Albuquerque
Maritime	VE1DQ	<b>MARITIME DIVISION</b> A. M. Crowell	69 Dublin St.	Halifax, N. S.
Ontario	VE3GT	<b>ONTARIO DIVISION</b> S. B. Trainer, Jr.	4 Shorncliffe Ave.	Toronto
Quebec*	VE2GA	<b>QUEBEC DIVISION</b> J. A. Robertson	245 Edison Ave.	St. Lambert, P. Q.
Alberta British Columbia	VE4GD VE5AC	<b>VANALTA DIVISION</b> J. Smalley, Jr. R. K. Town	611 1st Ave., N. W. 1754 Graveley St.	Calgary Vancouver
Manitoba Saskatchewan	VE4GC VE4EL	<b>PRAIRIE DIVISION</b> Reg. Strong Wilfred Skaife	711 Ashburn St. 2040 McTavish St.	Winnipeg Regina

\* Officials appointed to act until the membership of the Section choose permanent S.C.M.'s by nomination and election.

# Fourth All-Section Sweepstakes Contest Results

By E. L. Battey, Assistant Communications Manager

**T**HE greatest get-together in the history of Amateur Radio" is the best single sentence to report the results of the Fourth All-Section Sweepstakes Contest, held the nine days December 9th to 18th. New friendships, operating ability improvement, a test for transmitting and receiving equipment, an opportunity to contact new states and A.R.R.L. Sections, an exemplification of the true "amateur spirit," and a whale of a lot of good operating fun are some of the things which "Sweepstakes" means to everyone who has ever taken part in one of these Annual National QSO Contests.

In the words of some who were active in the 4th SS: "I certainly had a fine time, met a bunch of new fellows and increased my operating efficiency"—W6GAL. "Not much power, not much time, not much of a score, but a lot of fun"—W2DDV. "Learned more about snappy message handling than ever knew before"—W7BRU. "Haven't had as much fun since we used the Wouff Hong on a couple of off-frequency squirts here."—W8FZI. "It certainly improves the code speed and copying ability"—W9HUO. "The most enjoyable period of operating I have experienced in 13 years"—W9EF. "Although I will not receive a prize, the practice I got copying messages through QRM is a prize in itself"—W9LZQ. "I made a small score but got a year's experience in traffic handling"—W6IQY. "The SS is an FB operating opportunity for those of us who normally don't have time to handle a lot of traffic. It gives us some real operating and relieves the monotony of our usual ham existence"—W8FYF. "One swell contest. The air was so full of 'CQ SS' that one fellow was calling 'CQ No SS'. Hi."—W3ADE. "Almost worked more stations during SS than for entire years 1931 or 1932."—W7EK. "Contests of this nature promote a closer feeling of friendship between fellow hams"—W6HZT. "States and sections which I have been unable to work before were worked during the ss"—W9CGP. "It was a fine contest and worked quite a few of my old friends"—W1BHM. "I never knew such enjoyment could be derived from a contest of this type"—W3AIR. "SS Contest a real thrill here. Found good support among non-contestants. Spirit among SS gang very FB"—W4CA. "The willingness of every station I QSOed to cooperate was the greatest tribute to the general amateur spirit of sportmanship that has ever been my lot to behold. My hat is off to the greatest bunch of good sports in any hobby."—W3BYF. "My object in entering SS was to gain traffic experience. The contest taught me plenty."—W6JMR. "I got more kick out of the SS

than the answer to my first CQ."—W9OSQ. "Before this contest I didn't know much about traffic work, but now if there was an emergency and I was called upon for communication I could provide same effectively, using the proper procedure and efficient operating."—W5CPB.

The 1933 Sweepstakes had a bigger national participation than any previous amateur contest, barring none. And what operating enjoyment! 908 operators reported scores totalling 4,495,514, an average of 4951 points per operator! 151 operators scored over 10,000, 83 over 15,000, 51 over 20,000, 26 over 25,000, 17 over 30,000, 8 over 40,000! Competition was greater than ever before witnessed! 77 operators worked stations in 50 or more sections, 34 worked 55 or more, 13 worked 60 or more! All 69 Sections of the League's field organization were active with scores submitted from all but Alaska and PI. It was truly a "Battle Royal"!

For the benefit of the uninitiated, the Sweepstakes is an annual QSO Contest, open to all amateurs in the 69 sections of the A.R.R.L. field organization. The idea is to work as many different stations in as many different Sections as possible, exchanging at least one message with each station as proof of "solid" QSO. If a message is sent and acknowledged, "one point" is scored; if a message is exchanged both ways, "two points" are scored. The summation of all points is multiplied by the number of Sections contacted for final score.

## LEADING SCORES

Certificates of Performance have been awarded to the highest scoring participant in each of 67 A.R.R.L. Sections (all except Alaska and P. I. where no scores were submitted). The winner in each Section is listed first among the scores for his Section, except where otherwise noted. Congratulations, winners! Yours is the glory for weathering the storm—and what a storm!

Highest scorer in all Sections is W9AUH with 62,622 points, a result of QSOs with 495 stations in 63 sections! Some record! W9GDH (opr D) came near being W9AUH's Waterloo, winding up with 61,842 points and contacts with 66 sections! A close race against the many other high scorers such as W9UM, 50,700; W4CA, 47,430; W9EF, 46,431; W6CXW, 42,042; W9BMA, 42,029; W6AHP, 40,326. . . . 30,888 points of W6AHP's score was made entirely on 14 mc. 'phone!

Other contestants with very high scores are W9BWJ, W9AQD, W6EXQ, W1FH, W8BGY, W6HPZ (opr FC), W9GBJ, W8GUF, VE3GT (opr Sam), W8EUY, W1DMD (ex-BFT),

W8FIP, W4BRG, W1AVL, W7EK, W9GWK, W9GGB, W9KEH. Each of these operators scored 25,000 or higher! Their results and the results of the many other contestants with noteworthy scores may be found by studying the list of scores. Special commendation is due every operator who scored as high as 20,000 or more, and those over 10,000 didn't exactly waste time. Nice work, all.

One of the most fascinating things in participating in a Sweepstakes Contest is to watch the score build up as new Sections are worked. As one operator puts it, "The first 1000 points are the hardest." After that as new stations, and especially new sections, are added the score climbs so fast that it is hard to quit the contest without adding "another section," and another, and another, and so on—it gets in the blood. W6AHP, W6CXW and W9GDH (opr D) set a new record for number of sections worked during an SS—each of these operators were QSO stations in 66 Sections! Will some one work *all 69* in the next SS? W9UM worked 65 sections; W9AUH and W9EF 63; W4CA 62; W9BMA 61; W6BIP, W6EXQ, W6UA, W7EK, W9GBJ 60; W5CCW, W6CLP, W6FFP, W6HPZ (opr FC) W9AQD 59; and VE3GT (opr Sam), W4AJY and VE5HQ 58.

The number of stations worked, in itself, is not

really a criterion of a final SS score. However, it is interesting to note the number of stations QSO'ed by some of the participants: W9AUH 495, W9BWJ 334, VE3GT 304, W4AAQ 265 (opr JB 210, FD 55), W3LA 260, W4BRG 257, W8BON 243, W4PL 218, W9DMA 208, W1APU 205, W4DW 182, W8FDY 172, W9PDE 165, W9CWG 148, W2DMY 125, W5DVR 121, W5BUI 106.

**CLUB PARTICIPATION**

To encourage local SS competition special certificate awards were offered to the highest scoring participant in each A.R.R.L.-affiliated club where three or more individual club members took part and submitted scores. Amateurs in approximately 98 different clubs submitted scores. Awards have been made to the highest scorer in 28 A.R.R.L.-affiliated clubs. Many others had only one or two entering the contest and were not, therefore, eligible to receive an award. The club-winners and their clubs are as follows: W4AAQ (opr JB), Birmingham (Ala.) Amateur Radio Club; W6FIT, Associated Radio Amateurs of Long Beach; W6AZX, Associated Radio Amateurs of San Francisco; W7EAW, Roosevelt High Radio Club, Seattle; W7ABH, Portland Sevens (formerly Rose City A.R.C., Portland, Ore.); W9FZO, Tri-State Amateur Radio Club; W3ATR, Beacon Radio Amateurs,

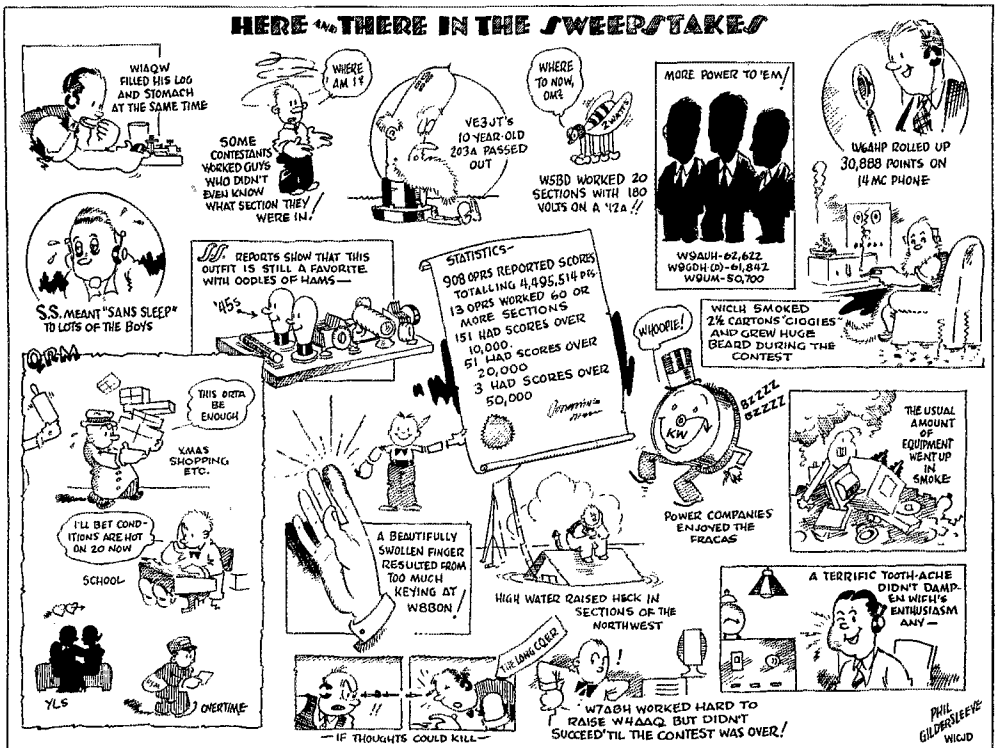

Phila.; W3AKB, Frankford Radio Club, Phila.; W8GIJ, Southern Tier Transmitting Amateurs, W.N.Y.; W8IFY, Boys' Club of St. Marys, Inc. (Pa.); W2FPH, Tri-States Radio Club, Port Jervis, N.Y.; W2DEG, Schenectady (N.Y.) Amateur Radio Association; VE3RF, The Queen City Amateur Radio Club, Toronto; VE2CD, Montreal Amateur Radio Club; VE5EC, Victoria Short Wave Club (B. C.); W1CTI, Connecticut Brass-pounders Association; W1BYW, Twin City Radio Club of Conn. (New Haven); W1CUO, Norfolk County Radio Association (Norwood, Mass.); W1BZA, Worcester (Mass.) Radio Association; W5ADZ, Houston Amateur Radio Club; W8BON, The Lakewood (Ohio) Radio Club; W9FLH, Central Illinois Radio Club; W8EHO, Cleveland Heights (Ohio) Amateur Radio Club; W9BQM, Fond du Lac (Wis.) Amateur Radio Club; W9EYH, Milwaukee Radio Amateurs' Club, Inc.; W9KA, Chicago Radio Traffic Association; W9KQQ, Chicago Amateur Radio Club; W9CUH, Waukegan (Ill.) Radio Club.

#### USE OF FREQUENCY BANDS

Without any question 3.5, 7 and 14 mc. are still the three most popular SS operating bands, with 1.7 mc. coming in for a good proportion of activity. For the first time in an SS contest 56 mc. was used by some contestants to obtain points locally. Among the 56 mc. SS gang were W1BEF, W1KH and W3AIR. Approximately 70.7% of all 1933 SS contestants used the 7 mc. band either full or part time; 67.3% used 3.5 mc.; 36.5% used 14 mc.; 5.8% used 1.7 mc. As to "exclusive" use of bands: Approximately 22.8% of all contestants used the 3.5 mc. band only; 17.2% used 7 mc. only; 2% used 14 mc. only. 20.2% combined their efforts to 3.5 and 7 mc.; 17.2% worked three bands, 3.5, 7 and 14 mc.; 12% used 7 and 14 mc.; and 2.3% used 3.5 and 14 mc. "What band proved most productive?" we are asked. In reply, we might first consider these facts:—W1CLH (Conn. winner) and W4AG (Ala. winner) used 7 mc. only, W2BZZ (E.N.Y. winner) used 3.5 mc. only, W1FH (E.Mass. winner) used 7 and 14 mc., and W9AUH (National high) used 3.5 and 7 mc. These may be considered "representative" participants. On the basis of what they did and considering the percentages shown above, it is reasonable to say that 3.5 and 7 mc. are the best SS bands, with 14 mc. being highly valuable for snagging some of the distant sections.

#### PHONE PARTICIPATION

Considerable SS activity was reported by operators whose stations are equipped for voice work. Foremost among these is W6AHP, who made 30,888 points using phone on 14 mc.—his total score was 40,326! His power was 300 watts input to type '52s. W9ACU's 10,010 points were

made using phone exclusively in the 3.9 and 14 mc. bands with an input to the final stage of 10 watts. A real record for low power phone! The final stage at W9ACU employed a '12A drawing 50 m.a. with 200 volts on the plate, W8EMP, using 1.75 mc. phone exclusively, came through with a score of 1632 on the strength of contacts with 54 stations in 16 sections—the best contest record ever reported on 1.75 mc. phone! FB, OM. Using 3.9 and 14 mc. phone exclusively W8CTN made 2730 points (21 sections), putting 100 watts into an '03A final. Others using phone exclusively were W7ARK (1.75, 3.9 and 14 mc.) and W9FRC (3.9 mc.). Most of W9CSU's 5792 score was made using phone on 1.75, 3.9 and 14 mc. with a type '10 in the final. Many others did part of their work on phone, among them W1GEY, W2BGD, W4AAQ, W4AGY, W4APU, W4DD, W4EF, W4GS, W4LS, K6BAZ, W6EUP, W8FIP, W8JM, W9BHH, W9BOP, W9CWD, W9HCO, and W9LLV.

#### LOW MEDIUM-POWER ACHIEVEMENTS

The Sweepstakes is one contest where "low power" is not a handicap to getting full enjoyment from participation, nor does it prevent one from running up a good score, even a *winning* score. Operating ability and judgment have proven of much greater benefit than power in practically every instance. An inspection of logs received reveals the following interesting figures approximate on the transmitting tubes in use in the last stage of transmitters at stations entered in the 1933 SS:

A single type '10	28%
Two type '46s	15%
Two type '10s	10%
A single "50 watter"	8%
Two type '46s	7%
A single type '45	6%
A single type '52	3%
A single type '12A	2%

Among other transmitting tube equipment in use to a lesser degree were: 1.2% each: single '46, single '47, two '47s, single '71A. And .6% each: single '01A, two '01As, two '52s, single '60. Note that only about 12% used tubes larger than the type '10 in this contest, and witness the scores!

Should there be any "Doubting Thomases" who question that low power really *can* do it, we request that they inhale the following dope on actual accomplishments: W8AQE operating on 3.5 mc. made 5616 points. 27 sections, with '33s in a crystal oscillator (200 v. B batteries on plates, 35 m.a.)! 9553 points (41 secs.) is W8FDA's record using a '71A TNT with 200 volts "B" batts! W1DUJ, with a single '71A TNT, made 4433 (31 secs.). Among others in the "ultra-low" power class were W5BD ('12A TNT 180 v.), W5CPT ('12As P.P. & '01As P.P.W 4 watts inp.), W1CGV ('12A xtal osc., '12A amp., 5-6

(Continued on page 180)



W2AXZ (31).. 5872 New England Div. W1BKQ (9).. 468<sup>22</sup> W6ANN (42).. 8484 W4TP (41).. 7667 Oklahoma 42,117

W2EYQ (30).. 5820 423,113 W1DIE (8).. 288 W6EGS (43).. 8385 W4QN (27).. 3213 W5BDX (48).. 11328

W2AHC (35).. 5285 W1EFP (8).. 208 W6GLA (45).. 7425 W4CGH (26).. 2834 W5UCU (48).. 10512

W2DWW (24).. 5160 E. Mass. 130,775 W1EFT (3).. 66 W6DZR (33).. 5577 W4AVT (23).. 2277 W5CEZ (41).. 10414

W2EGA (26).. 5096 W1FH (54).. 33048 W1EJK (3).. 208 W6HDT (32).. 4896 W4BUE (20).. 1700 W5CJZ (45).. 9855

W2AOD (27).. 3780 W1ME (49).. 19600 W1EJA\* (1).. 4 W6FDE (33).. 4026 W4AAE (9).. 234 W5CXF\* (2).. 8

W2CUD (21).. 3633 W1EJV (42).. 15750 Rhode Island 18,509 W6GNM (24).. 2832 W4CP (8).. 128

W2BCB (25).. 2150 W1CUO (39).. 11437 W1BLV (33).. 14190 W6FXL (25).. 2525

W2AGL (20).. 1520 W1BZW (34).. 10401<sup>18</sup> W1GTN (17).. 2159 W6FZL (26).. 2496 West Va. 20,414

W2GP (16).. 1344 W1ABG (33).. 8382 W1BUX (24).. 2088 W6DHY (26).. 1896 W8T (49).. 11662 W5ADZ (34).. 7770

W2FPT (22).. 1144 W1EBF (31).. 8215 W1FNE\* (6).. 72 W6BMN (20).. 1480 W8JM (32).. 4224 W5BDI (34).. 5474

W2DJP (19).. 1026 W1RY (32).. 7424 W6PD (18).. 1152 W8KWU (26).. 2362 W5IE (29).. 3567

W2BWW (17).. 1020 W1RY (36).. 4824 Vermont 17,295 W6ATF (15).. 900 W8JCB (23).. 2047 W5DOM (23).. 2116

W2FET (15).. 1020 W1DDC (17).. 1700 W1ELR (31).. 7068 W6BGF (15).. 585 W8JWL (7).. 119 W5BD (20).. 1200

W2DSR (15).. 750 W1KH (21).. 1596 W1EPC (34).. 5882 W6EUP (10).. 330

W2BII (14).. 616 W1BSF (18).. 1566 W1FN (23).. 1817 W6FQK (8).. 224

W2FRK (10).. 590 W1ECK (17).. 1496 W1EMQ (17).. 1377 W6ETJ (8).. 176

W2EQE (16).. 496 W1CHR (19).. 1482 W1CGV (17).. 595 W6HAI (7).. 168 W3CWS (37).. 4995<sup>28</sup>

W2CMU (14).. 434 W1GEN (17).. 1173 W1AXN (10).. 330 W6BPU\* (8).. 160 W3DCU (24).. 1944

W2DRG (48).. 360 W1VS (14).. 742 W1GAE (8).. 224 W6IDZ (5).. 150 W3AZU (20).. 1180

W2BPT (10).. 270 W1BNT (15).. 630 W1ATF\* (1).. 2 W6AM (6).. 90 W3BAD (11).. 308

W2DYF (9).. 326 W1ECL (14).. 544 W6IRD (4).. 72

W2CHK\* (7).. 224 W1GRS (10).. 290 NORTHWEST DIV. 208,093 W6IEQ (2).. 6

W2FNI (5).. 150 W1FET (5).. 60

W2CEI (6).. 114 W1AXA\* (1).. 2

W2AQO (5).. 50

W2CYA (4).. 8

W2BGD (21).. 4

W2BWD (1).. 4

E. New York 58,856

W2BZZ (42).. 20260 W1BSS (32).. 9082 Oregon 81,484 W2FEH (51).. 15555

W2ERM (37).. 10860 W1BHM (33).. 6072 W1BDB (46).. 13662 W7DBR (46).. 13662

W2AXX (35).. 8365 W1GME (25).. 3350 W7AFM (37).. 9657 W7WAZ (31).. 2961 W7ABC (45).. 13654

W2DEG (26).. 4628 W1DOV (31).. 5301 W7HDH (17).. 1887 W7CWL (21).. 2592 W9GJV (11).. 308

W2FPH (29).. 3625 W1DFZ (26).. 3900 W7CQZ (19).. 1577 W6HSA (7).. 287 W9EIJ (9).. 171

W2ACP (24).. 3190 W1BDI (26).. 3016 W7AFC (12).. 744 W6JMR (8).. 160 W9CDE (4).. 32 W9YFK\* (1).. 1

W2BRS (21).. 2310 W1AVV (29).. 2552 W7BWD (10).. 440

W2BLU (25).. 2100 W1UE (25).. 2050 W7AIG (9).. 423 San Joaquin Val. 74,748

W2BXJ (20).. 1860 W1GHI (22).. 2024 W7DUE\* (12).. 264 W6HLPZ (60).. 37200<sup>23</sup>

W2DYG (15).. 900 W1CJD (20).. 1800 W7DXC (4).. 80 W6CLP (59).. 20709

W2AQN (16).. 832 W1MK (25).. 1875<sup>19</sup> W7ECO\* (5).. 80 W6FFP (59).. 19421

W2ATM\* (9).. 351 W1KIE (13).. 741 W7ATC\* (3).. 24 W6AGV (12).. 708

W2CVL (5).. 75 W1GUC (12).. 672 Washington 70,155 W6EPQ (14).. 700

W1EFP (14).. 658 W7DUE\* (12).. 264 W6BIL (16).. 640

W1GZD\* (14).. 532 W7EAK (60).. 20640 W6GEG (10).. 460

W1GTH (11).. 517 W7AGE (43).. 14061

W1WAP (13).. 403 W7TS (38).. 6232 San Diego 44,987 W6UA (60).. 22640

W9GDH (66).. 62890<sup>15</sup> W1BWM (12).. 348 W7CQB (31).. 4588 W6UAU (58).. 18212 W4AJY (58).. 16328

W9AHR (54).. 21168 W1GGM (10).. 250 W7DVT (26).. 3124 W6BAM (50).. 15050 W4B0U (60).. 14750

W9DFY (46).. 11868 W1EJQ (8).. 176 W7DYZ (28).. 3924 W6BHV (41).. 7175 W4DS (52).. 13728

W9PFL (32).. 8764 W1ES (8).. 176 W7LD (16).. 2352 W6FQU (4).. 72 W4D0 (30).. 3720

W9AWP (38).. 4288 W1AMG (5).. 120 W7BLX (21).. 2058 W4BZG (28).. 3444 W3BHP (16).. 352

W9QFR (26).. 2964 W1FTM (5).. 90 W7CND (15).. 1305 East Bay 36,082 W4BJP (23).. 1656

W9FMX (26).. 2626 W1CB (6).. 90<sup>9</sup> W7DLN (14).. 1162 W6HRN (44).. 12408

W9DMF (29).. 2523 W1GKM (3).. 54 W7AAX (15).. 705 W6ETG (39).. 10530 W4ATJ (23).. 2

W9JUT (22).. 1716 W1CRP\* (26).. 3460<sup>21</sup> W7ECM (2).. 6 W6WLC (42).. 7854

W9PB (15).. 720 New Hampshire 67,874 W7APR (12).. 480 W6AF (32).. 2688

W9MUJ (10).. 260 W1DMD (54).. 29106 W7BYB (10).. 480 W6AUF (19).. 1482

W9FR (6).. 228 W1AVL (53).. 27083 W7RT (12).. 480 W6BZX (11).. 440

W9LRR (10).. 190 W1ERG (20).. 3200 W7BYF (12).. 468 W6FII\* (13).. 390

W1AG0 (17).. 2344 W7DJJ (8).. 3860<sup>23</sup> W6IY (10).. 290

W1GEY (22).. 2090 W7EW (10).. 350

W1BAA (21).. 2079 W7EAW (7).. 245

W1BWB (22).. 1364 W7ALS (9).. 225

W1BLA (11).. 429 W7BET (5).. 190

W1BKF (43).. 7439 W1HFO (9).. 279 W7DGY (7).. 182

W1BED (45).. 7155 W7BG (7).. 119

W1BHG (30).. 4140 W7DGN (4).. 92

W1BML (26).. 2496 W1APU (46).. 18584 W7CWN (5).. 90

W1DUB (25).. 2400<sup>18</sup> W1CPT (43).. 13975 W7WY\* (5).. 90

W1GTC (19).. 1330 W1BEM (25).. 6025 W7BHG (3).. 65

W1NEA (20).. 1080 W1OR (26).. 5928 W7DRD (3).. 30

W1DIC (15).. 750 W1DUP (31).. 4433 W7AEQ (4).. 28

W1DUD (6).. 96 W1CRP\* (26).. 3460<sup>21</sup> W7ECM (2).. 6

W1AQW (19).. 2052

W1GEB (13).. 1443 Montana 50,108 W7ADS (26).. 4108

W1BWF (53).. 15317 W1DRQ (15).. 1300 W7AAT (45).. 17640 W6BSV (16).. 1152

W1GUD (47).. 12843 W1BTK (15).. 1200 W7BVE (53).. 17442 W6DVE\* (13).. 702

W6CWG (42).. 13848 W1BAD (13).. 312 W7BSY (40).. 10040 W6CAC (11).. 550

W9JCS (50).. 11300 W1GMD (48).. 288 W7BYU (36).. 4580 W6JNB (5).. 140

W9ERY (42).. 8820 W1DHH (7).. 196 W7DTC (9).. 126 W6ISX (2).. 12

W9FTZ (34).. 5712 W1CXD (9).. 171

W9NTY (35).. 5145 W1TE\* (8).. 160 Idaho 6386 W6GYX (15).. 1920

W9JSO (29).. 3306 W1FUO\* (6).. 72 W7BMF (27).. 3834 W6UO (13).. 1144

W9MHV (27).. 3024 W1WY (27).. 4131 W7CHT (18).. 1782 W6HGL (11).. 682

W9JMB (28).. 2016 W1WY (45).. 16830 W7BRU (11).. 770

W9FYX (12).. 456 W1COI (36).. 9360 Pacific Div. 513,694 W7RIS (14).. 1386

W9DIB (2).. 12 W1FAJ (27).. 4131 K6BAZ (14).. 1386

W1COC (24).. 3768 Los Angeles 222,555 W6CKX (66).. 42042 K6AJA (18).. 954

W9DMY (52).. 17264 W1ROB (25).. 3450 W6EXQ (60).. 33120 K6CQZ (5).. 90

W9JZX (39).. 7566<sup>17</sup> W1DR (20).. 3040 W6AHP (66).. 40326

W91FE (26).. 4732 W1BHH (20).. 1780 W6EXQ (60).. 33120

W9DI (20).. 1660 W1FNY (19).. 1501 W6VNU (52).. 23140

W9JEE (18).. 918 W1DPA (11).. 528 W6CVZ (54).. 20628

W9EJF (18).. 864 W1BZA (9).. 522 W6FTB (46).. 9062



# • I. A. R. U. NEWS •

Devoted to the interests and activities of the

## INTERNATIONAL AMATEUR RADIO UNION

President: H. P. MAXIM

Vice-President: C. H. STEWART

Secretary: K. B. WARNER

Headquarters Society: THE AMERICAN RADIO RELAY LEAGUE, West Hartford, Conn.

### MEMBER SOCIETIES

American Radio Relay League  
Associazione Radiotecnica Italiana  
Canadian Section, A. R. R. L.  
Českoslovenští Amatéri Vysílací  
Deutscher Amateur Sende-und-Empfangs  
Dienst  
Experimenterende Danske Radioamatører  
Liga Mexicana de Radio Experimentadores

Nederlandsche Vereeniging voor Internationaal Radioamateurisme  
Nederlandsch-Indische Vereeniging Voor Internationaal Radioamateurisme  
New Zealand Association of Radio Transmitters  
Norsk Radio Relæ Liga  
Polski Związek Krotkofalowcow  
Radio Society of Great Britain  
Rede dos Emissores Portugueses

Reseau Belge  
Reseau Emetteurs Français  
South African Radio Relay League  
Suomen Radioamatööriyhdistys  
Sveriges Sandareamatörer  
Unión de Radioemisores Españoles  
Union Schweiz Kurzwellen Amateur  
Wireless Institute of Australia  
Wireless Society of Ireland

Conducted by Clinton B. DeSoto

**A**MIDST all the shouting and celebration of the twentieth anniversary of the A. R. R. L., we must not lose sight of the fact that the International Amateur Radio Union is also celebrating a significant anniversary at this time. The story of the birth of the I. A. R. U. is one with which many of our readers are not familiar. It is an impressive story, and one which every amateur should know. We take this opportunity to recount the tale again.

It was ten years ago that the International Amateur Radio Union was formed, although a permanent organization was not achieved until the following year. On March 12, 1924, leading representatives of the amateurs of nine nations, the most distinguished radio men of Europe, tendered an honorary dinner to Hiram Percy Maxim, president of the A. R. R. L., at the Hotel Lutetia in Paris. At that meeting it was decided to undertake the formation of an international radio organization. The name of the society was chosen, and a temporary committee under the chairmanship of Mr. Maxim appointed to take charge of details for arranging a permanent organization. The A. R. R. L. was requested to draft constitutional recommendations, and transmit them to this committee. Finally, a general Amateur Congress was voted to be called during the Easter holidays of 1925, at which time the Union could be formally organized and inaugurated.

On April 14, 1925, the opening session of the First International Amateur Congress convened in the *Faculte des Sciences*, in joint

meeting with the International Radio Legal Committee, with a total attendance of around 250. Amateur representatives from twenty-three nations were in attendance. The gathering was welcomed by M. Edouard Belin, president of the *Radio Club de France*, and by General Ferrie. In late afternoon the two bodies met separately, and the business of the Amateur Congress began. M. Belin was elected president of the Congress, Messrs. Maxim and Marcuse (g2NM) vice-presidents, and M. Beauvais and Mr. Warner secretaries. Sub-committees were appointed to consider the various subjects of business, and proceeded to work.

The most important work of the conference centered in Sub-Committee No. 1, on the subject of formation of the I. A. R. U. There were about fifty members on this committee, from each of the twenty-three nations. Mr. Maxim was elected

(Continued on page 126)



HANDS ACROSS THE SEA—AMERICA, FRANCE, GREAT BRITAIN  
Mr. Maxim, M. Belin, Mr. Marcuse

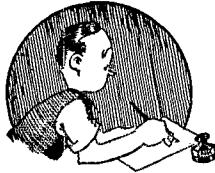

# CORRESPONDENCE

The Publishers of *QST* assume no responsibility for statements made herein by correspondents

## "I Never Overmodulate!"

5236 Guilford, Indianapolis

Editor, *QST*:

I have read the several articles in *QST* as well as the "Crab" letters written by several of the boys concerning overmodulation. Each time, I have pooh-poohed the idea that my rig could possibly be one of the offenders, since my plate meter in the final stage stayed still and the antenna meters only increased about 20% on modulation peaks.

Tonight I saw the light. We borrowed a cathode-ray oscillograph, and, upon barking into the mike, found the carrier was mostly fuzzy peaks and long flat-bottomed valleys. The result was a greatly reduced gain on the audio end. Upon calling several of the 75-meter addicts with no response, we concluded that it took about 400% modulation to get out. So up went the gain, and finally some guy located our little 300-watt signal and came back. We inquired as to which sounded better, and he said without a doubt the 400% was far more understandable than the 100% modge.

I don't question his integrity, but am convinced that if more cathode-ray rigs were in use among hams, there would be fewer of the 400% modulation signals, more room for the rest of us, and the reports from other stations would most certainly differentiate between the 400% and 100% in decided favor of the 100% signal.

Distortion estimates on the modulated carrier here show somewhere around 4 to 5 percent harmonics. This is certainly impossible for the average ear to recognize. Frequency response of the speech equipment is plus or minus 3 or 4 db. over a range of 100 to 8000 cycles, certainly good enough to pass on any ham band. Modulation percentage averaged about 80 during the contacts of the evening, and while a few of the boys gave us encouraging reports, the greatest proportion of the replies proved to us that the ham on 75 meters only concerns himself with "How loud is this guy?", rather than "How good a signal has he?" His judgment is based on what-he-hears-on-the-average as a standard.

Is there *no* way in which the American 'phone ham can be taught that less than 100% modulation, average, will still give him 100% peaks, and that 80% average modulation is *puh-lenty*? I am sure that if *QST* would lay some active stress on this subject, there would be less agitation for more kilocycles to clutter up with wide side-

bands, and more serious effort to apply NRA principles to ham radio and have every 'phone man do his part.

— M. C. Bartlett, W9JHY

## On the Antenna Filter

San Antonio, Tex.

Editor, *QST*:

. . . Never before have I asked to have anything printed in *QST*, but I would like to express my most sincere appreciation to you and the author of the article on antenna matching systems appearing on page 15, February, 1934, *QST*. That little article has made me one of the happiest and most contented hams in all hamdom. Let me pass the good word along.

Several weeks ago I finished my new c.c. rig. . . . Results were fair considering the low power used. Then I read and digested that little article, and in just thirty minutes had haywired it into my rig. Results were surprising. Antenna current had increased from one amp. to nearly two-and-one-half. After several QSO's I was convinced it was nothing short of miraculous. . . . Reports from all over the U.S.A. have averaged QSA 5 R6. . . . Best of all, my harmonic on 20 meters had nearly disappeared (my transmitter being on 40).

When the gang gets wise to this new system we will not only have better signals on the air, but much less QRM from harmonics. It's the best thing I've seen since we threw away our cat whiskers for the vacuum tube! . . .

— William F. Bonnell, W65CVW  
Lt. Air Corps Res.

## An Appeal to the Aussies

189 Elm St., Northampton, Mass.

Editor, *QST*:

Speaking of anniversaries it would seem that a change is in order. For the past decade American amateurs, especially those east of the Mississippi, have had many thousand contacts with our Antipodean brethren "down under" at the expense of getting up at dawn or before for this privilege. We haven't begrudged the Aussies or Zedders this time—we've enjoyed it. But, what say that for the next decade we reverse the procedure? It is a known fact that the VK's put through nice signals around 4 and 5 p.m. E.S.T.—which is just 12 hours advanced. We used to



This month we are going to interrupt our program of technical comments scheduled for this page to make the ARRL's twentieth anniversary the occasion of a tribute to the League's work in making present day amateur radio possible. In particular, we refer to the aggressive and successful battle which the League has waged through its president, H. P. Maxim, and its executive secretary and diplomat, K. B. Warner, by

which the amateur enjoys his privileged position in the high frequency spectrum.

And since one cannot very well speak of the League without mentioning QST, we take this opportunity of bowing to the QST staff. They need no tribute from us, for the back numbers of QST are a history of Amateur Radio, a record of its traditions, and a text book of its technical practice. However, they have done much more than record progress. Their contributions, such as Single Signal reception, have been very real and lasting. Amateur Radio would be a strangely empty hobby without QST.



We were tempted to "horn-in" on the birthday celebrations ourselves. It is NATIONAL's Twentieth birthday, too. However, this is the League's party and we will make our own celebrations private. A toast to the gentlemen from West Hartford! May their work be as fruitful in the next twenty years as in those just passed!

JAMES MILLEN



# Sylvania

## TYPE 210



# 5<sup>75</sup>

The Sylvania 210 is a general purpose air cooled triode employing the highly efficient graphite anode construction. A low loss ceramic base is utilized in order to keep R.F. losses at a minimum. The "floating anode" principle is made use of in order to improve insulation and reduce capacity. This unique feature is accomplished by insulating the supporting structure electrically from the active elements. Write for Engineering Information.

### HYGRADE SYLVANIA CORPORATION

ELECTRONICS DEPARTMENT  
AMATEUR RADIO DIVISION  
CLIFTON, N. J.

FACTORIES:

EMPORIUM, PA.  
SALEM, MASS.



ST. MARYS, PA.  
CLIFTON, N. J.

term this an accomplishment. However, with receiver progress and transmitter advancement it has become a daily occurrence.

What say, Aussies? At least give us some sleep on week-ends by practicing this gentle art of the "long 'way 'round." Maybe a QSO party at this time of day would stimulate interest at both ends.

—Charles N. DeRose, W1CND

## Morse vs. Continental Technique

Atlanta, Ga.

Editor, *QST*:

Why is it that some "Morse" or "Converted Morse" men continue to hang on to the idea that the only real top-notch operator is one who cut his teeth on a sounder? I note that W9DEA makes the insinuation in his comment in March, *QST*, headed "Copying Behind," that only Morse operators ever acquire the habit of copying behind. Why doesn't somebody inform him that copying behind is one of the fundamentals of operating where heavy traffic is handled, and that every good "Continental" operator realizes it, and doesn't brag about his ability to copy behind any more than he would brag about being able to distinguish A from Z?

—Olan Richardson, W4CAO

## New Canadian 'Phone Regs.

**E**FFECTIVE April 1st, the Canadian government has announced new regulations for amateur 'phone. "Equipment conditions" are now specified for all operating except on the ultra-high-frequencies, including the 1715- to 2000-ke. band which heretofore has been unrestricted. The bands and their conditions are as follows:

1715-2000 kc. Open to any amateur but subject to equipment conditions.

3500-3550 kc., 3900-4000 kc., 14,100-14,300 kc. Subject to equipment conditions. In addition the licensee must have been the holder of an amateur experimental license for at least two years, during which period his station shall have been in active operation on either c.w. or 'phone. Licensees who desire such authorization must make written application to the nearest divisional radio office.

28,000-28,500 kc., 56,000-60,000 kc. Equipment conditions do not apply. Open to any amateur.

The equipment conditions are intended to insure proper 'phone operation and are a great deal more specific than U. S. regulations. To operate 'phone on anything but the high experimental frequencies, the station must be equipped with a reliable frequency meter; the transmitter must be of a type in which a power amplifier feeds the antenna and is excited by a master oscillator which is preferably crystal-controlled, or which has a stability and constancy comparable to that of a crystal-controlled oscillator; while the modulation system must be so designed and operated as to ensure intelligible speech, must not in any

# GROSS TRANSMITTERS

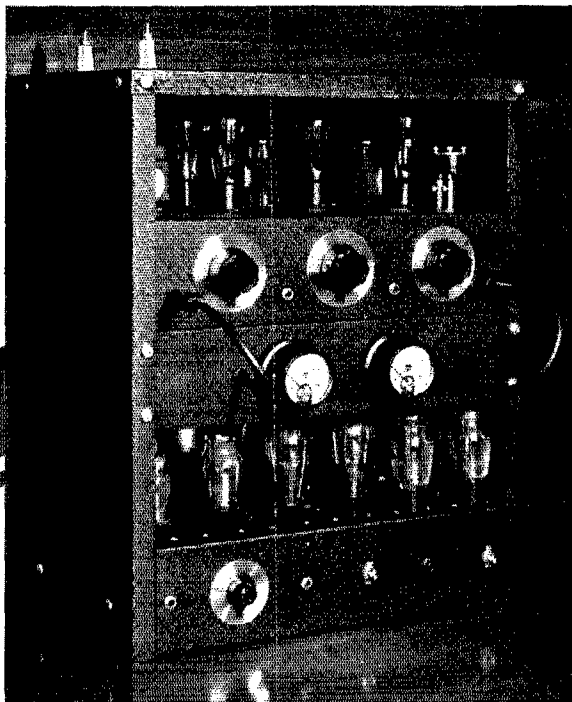

Illustrated is the new model CB-45 Radiophone and C.W. transmitter. Output 25 to 28 watts—100% Class-B modulation—operates on all amateur frequencies—entirely self-contained from microphone jack to antenna coupling coil. Price, less tubes, \$100 list, less 40% discount to amateurs. Also available in kit form at \$110 list.

## Built to the Highest Standards of Quality and Performance

By fortunate combination of ingenious design and skillful construction, Gross transmitters offer a degree of perfection which we believe is unexcelled. Enthusiastic users in this and foreign countries testify to their high order of satisfactory performance. Literature descriptive of these outstanding transmitters will be sent upon request.



## GROSS RADIO INC.

51 VESEY STREET, NEW YORK, N. Y.

# Sylvania

## TYPE 830

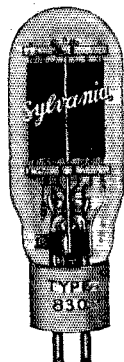

# 875

The Sylvania 830 will deliver 55 watts into the antenna from a class "C" final amplifier with only 750 volts on the plate. A ceramic base is used on the 830 in order to give maximum electrical efficiency at this point. A pair of graphite anode 210's in class "B" service will fully modulate the output of this "baby fifty watter". The Sylvania 830 is just the tube for the amateur who wishes to change from the 210 class to the 50 watt class, but feels he cannot afford the 830's big brother—a 203-A. Write for Engineering Information.

## HYGRADE SYLVANIA CORPORATION

**ELECTRONICS DEPARTMENT  
AMATEUR RADIO DIVISION  
CLIFTON, N. J.**

FACTORIES:

EMPORIUM, PA.  
SALEM, MASS.



ST. MARYS, PA.  
CLIFTON, N. J.

case exceed 100% modulation, and must not disturb the frequency stability of the transmitter.

All licensed stations, whether 'phone or c.w., are now authorized to operate as portable in the band 56-60 mc. within the province in which licensed, but simultaneous operation of the portable and the "fixed" station is not permitted, nor is portable operation on other bands.

### Standard Frequency Transmissions

Date	Schedule	Frequency	Date	Schedule	Frequency
May 4	B	W9XAN	June 6	C	W9XAN
May 9	C	W9XAN	June 8	B	W9XAN
May 11	B	W9XAN	A	W6XX	
	A	W6XX	June 13	BB	W9XAN
May 16	BB	W9XAN	June 15	BB	W6XX
May 18	BB	W6XX	A	W9XAN	
	A	W9XAN	June 16	BX	W6XX
May 19	BX	W6XX	June 17	C	W6XX
May 20	C	W6XX	June 22	A	W6XX
May 23	A	W6XX	June 29	B	W9XAN
June 1	B	W9XAN	B	W6XX	
	B	W6XX			

### STANDARD FREQUENCY SCHEDULES

Time (p.m.)	Sched. and Freq. (kc.)		Time (p.m.)	Sched. and Freq. (kc.)	
	A	B		BB	C
8:00	3500	7000	4:00	7000	14,000
8:08	3600	7100	4:08	7100	14,100
8:16	3700	7200	4:16	7200	14,200
8:24	3800	7300	4:24	7300	14,300
8:32	3900		4:32		14,400
8:40	4000				

Time (a.m.)	Sched. and Freq. (kc.)
6:00	7000
6:08	7100
6:16	7200
6:24	7300

The time specified in the schedules is local standard time at the transmitting station. W9XAN uses Central Standard Time and W6XX, Pacific Standard Time.

### TRANSMITTING PROCEDURE

The time allotted to each transmission is 8 minutes divided as follows:

- 2 minutes—QST QST QST de (station call letters).
  - 3 minutes—Characteristic letter of station followed by call letters and statement of frequency. The characteristic letter of W9XAN is "O" and that of W6XX is "M."
  - 1 minute—Statement of frequency in kilocycles and announcement of next frequency.
  - 2 minutes—Time allowed to change to next frequency.
- W9XAN: Elgin Observatory, Elgin National Watch Company, Elgin Ill., Frank D. Urie in charge.  
W6XX: Don Lee Broadcasting System, Los Angeles, Calif., Harold Peery in charge.

### The Regenerative S. S. Receiver Brought Up to Date

(Continued from page 68)

were obtained. This gave such a strong oscillation that the second detector was completely overloaded. The rectified grid voltage on the oscillator was approximately 10 volts and the second detector plate current dipped from 20 to 6 ma. With  $R_{15}$  increased to the specified value of 50,000 ohms, however, the screen voltage was dropped to about 10 volts, the rectified grid voltage to about 3 volts and a moderate signal was provided for mixing in the second detector.

# Congratulations ARRL!

20 BIRTHDAYS—that's some years to look back on—but what strides you've made in that time. We are proud of the fact that we have contributed our mite toward your success.

## Coincident with this auspicious occasion

We introduce a NEW SERVICE and a number of new units designed for the amateur. This is only the beginning of our expansion program to meet your demands for quality equipment at reasonable prices. Wait until you see our new 5-meter apparatus, new low frequency transmitters, LEEDS "demi-bases," but enough — just look over the gadgets pictured below.

### LEEDS Type 1-B Frequency Meter MONITOR

Fully described in April issue *QST*. This instrument sets a new standard in freqmonitor design. This 2-purpose instrument furnished complete with 2 tubes and large calibration chart for ..... **\$19.75**  
Complete kit of parts (less tubes) **\$11.45**



Type 1-A Frequency Meter, for general short wave coverage is also available. This instrument is similar in appearance to the 1-B but the electron coupled oscillator operates in the broadcast band so that its harmonics cover the entire short wave spectrum. An audio oscillator takes the place of the detector employed in the amateur model, so that an easily recognizable modulated signal may be heard in short wave receivers that do not have a beat oscillator incorporated in them. Furnished complete with 2 tubes and calibration chart .....

**\$19.75**

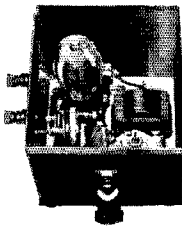

### LEEDS Type 1-D Frequency Meter CHECKER

Employing a type 24 tube in a 10 kc. E.C. oscillator circuit. In conjunction with a T R F broadcast receiver, accurate 10 kc. checking points may be obtained throughout the 80 and 160 meter bands for freqmeter calibration at any time. An inexpensive substitute for 100 kc. bars, multivibrators, etc. Furnished, wired and tested with tube for .....

**\$9.25**

Complete kit of parts with instructions (less tube) .....

**\$5.31**

### LEEDS Type 1-E POWER SUPPLY

Housed in attractive black crystalline finished steel can 5 x 6 x 9 — employs type 280 rectifier, double section filter with 18 mfd. condenser to insure humless operation. "B" supply 225 v. 50 mils. "A" supply 2½ v. 5 amp. Output multiplied to two UX sockets to fit the 1-A; 1-B or 1-D; UX plugs. May also be used with the SW-3 A.C. receivers. Price (less tube) .....

**\$8.35**

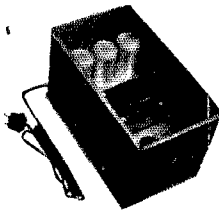

### LEEDS Type 1-C Wave Meter

For the first time an absorption type wave-meter with real band-spread. Each amateur band from 5 to 160 meters covers 50 degrees or more on the dial (6 coils). General coverage from 12 to 200 meters also available (4 coils). A 3½" cube that can be put into a tight corner without difficulty, furnished with a 60 mil indicating lamp, so that its sensitivity compares favorably with a thermo galvanometer. Completely wired, tested and calibrated with 10 coils .....

**\$15.00**

Complete kit of parts with instructions and 6 unwound coil forms .....

**\$4.25**

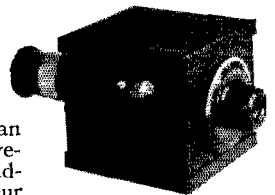

45 VESEY STREET, NEW YORK CITY  
New York Headquarters for Transmitting Apparatus  
and Short Wave Equipment

Say You Saw It in *QST* — It Identifies You and Helps *QST*

# Sylvania

## TYPE 825

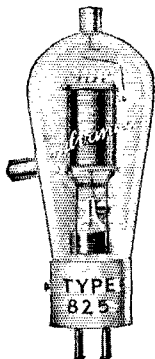

# 10<sup>00</sup>

The Sylvania 825 is especially an ultra high frequency oscillator. The power output in class "C" service is 40 watts. Grid and plate leads are brought out through the glass envelope to insure greatest efficiency. A ceramic base is utilized to further make this tube a pleasure to the eye and a masterpiece of tube engineering. It will give far superior results on 5 and 10 meters than tubes hitherto used in this ultra high frequency work. The 825 is another Sylvania transmitting tube which employs the "floating anode" type of construction. Write for *Engineering Information*.

## HYGRADE SYLVANIA CORPORATION

**ELECTRONICS DEPARTMENT  
AMATEUR RADIO DIVISION  
CLIFTON, N. J.**

FACTORIES:

EMPORIUM, PA.  
SALEM, MASS.



ST. MARYS, PA.  
CLIFTON, N. J.

With the values as given in Fig. 1, the beat oscillator gives optimum results on weak signals, not maximum output on strong signals. Since strong signals can take care of themselves and weak ones should be favored, this seems to be the best compromise. Of course if loud speaker reception should be desired on strong signals, the screen voltage of the beat oscillator would be increased by changing  $R_{15}$  to about 25,000 ohms.

The volume or gain control is such as to give complete cut-off so that one's own transmitter can readily be monitored with the antenna connected to the receiver.

### ACTUAL PERFORMANCE

As to results, the receiver has met expectations fully and complies with the requirements set forth at the start. The performance equals or betters that of many manufactured receivers costing considerably more. The single-signal selectivity is as complete as with receivers using crystal filters; which, according to the original theoretical discussion of J. J. Lamb, is as it should be. The audio image ("other side of zero beat") of a signal that is R9 on the peak is scarcely audible and is entirely unnoticed in practical operation. As an indication of the maximum selectivity obtainable, side bands on 'phones can be cut to unintelligibility; while with reduced selectivity 'phone reception is adequately intelligible and is greatly freed of QRM. All standard frequency transmissions can be taken without troublesome interference—which, with other receivers in the past, was an impossibility.

The "local" selectivity is such that stations within even a few kilocycles of the "next door" transmitters can now be worked. With selectivity reduced somewhat from maximum, duplex 'phone operation can be carried on within 25 kc. or less of my own transmitter frequency.

R.f. images are practically eliminated. With the shield cover off, a few images of high power commercials may come through, but with the cover on images previously located drop to R1. Incidentally, here is the simple test to identify an image. Suppose the c.w. beat oscillator and other adjustments of the receiver are such that rotation of the tuning knob in one direction causes the desired signals to peak while *increasing* in pitch. Then a commercial signal is observed to "peak on the wrong side of zero beat" and to *decrease* in pitch with the same rotation of the tuning knob. That signal is immediately spotted as an image.

The effective sensitivity is such that many foreign DX signals, which with usual receivers would be passed by in the background, are heard with local R9 strength. As for stability, European short-wave broadcasts have been held with loud speaker volume for over an hour and a half without touching a single control.

The shielding is entirely adequate. With the antenna disconnected the receiver is "dead" except for local high-power transmitters. No commercial marine traffic gets into the 500-kc. intermediate, although if an antenna is touched to the grid of the i.f. tube the circuit readily responds to



# Speaking of Anniversaries

Here's something worth knowing — **LEEDS** is the oldest Retailer, advertising continuously in *QST*. Unexcelled service and prices like these are the answer.

## MAY SPECIAL

### Crystal Prices Reduced



**LEEDS** precision ground Crystals 1" square, in the 160 or 80 meter bands, within .1 of 1% of the specified frequency.  
**Y cut \$2.25**      **X cut \$3.25**  
 X cut 40 meter crystals ground to the same degree of accuracy  
**\$4.95**

Quartz is Quartz—The usual Leeds guarantee of 100% satisfaction is back of our crystals. Can you ask for more?

### In Line With the New Crystal Prices

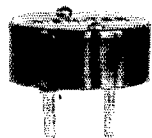

A new moulded bakelite crystal holder that fits a standard UY tube socket. Will accommodate crystals slightly larger than 1" square, furnished with light brass plates accurately lapped. Pressure on crystal may be readily adjusted. Dust proof of course.  
 Price **\$1**

### Flechthelm Condensers at new low prices

Type	Cap.	Working v.	D.C.	Price
Tc	100	.1 mfd.	1000 v.	<b>\$1.75</b>
Tc	200	.2 mfd.	1000 v.	<b>2.75</b>
T	100	.1 mfd.	1500 v.	<b>2.25</b>
T	200	.2 mfd.	1500 v.	<b>3.75</b>
Th	100	.1 mfd.	2000 v.	<b>4.25</b>
Th	200	.2 mfd.	2000 v.	<b>6.75</b>
HP	100	.1 mfd.	3000 v.	<b>9.00</b>
HP	200	.2 mfd.	3000 v.	<b>12.25</b>
VM	100	.1 mfd.	5000 v.	<b>13.50</b>

### DON'T BE FOOLED

by catalogs announcing prices reduced that end up by giving you the conventional 40% or 40% and 2% discounts to which you are entitled. As a *QST* advertiser we sell standard merchandise as low as anyone. Furthermore we have it in stock.

### FLASH

We held things up until the last minute to put this red-hot 56 MC Receiver dope in your hands

Our Engineer, W2AOE, has just finished a new 3-tube super regenerative receiver that's bound to make history in the ultra high frequency field. Radiation practically eliminated, increased sensitivity, greater volume, and the usually annoying rush is greatly reduced in level without "tone control" which cuts down volume and the higher audio frequencies. These are only a few of its features. Complete data sheet mailed on request.

5-A 56 mc Receiver..... **\$13.75**

### AT LAST!!

Antenna wire that's not like rubber. Just cut it to the proper length and forget it. It won't stretch.

No. 12 hard drawn tinned copper wire, 100 ft..... **.55c**  
 No. 10 hard drawn tinned copper wire, 100 ft..... **.85c**  
 No. 12 hard drawn phosphor bronze wire, 100 ft..... **.75c**  
 No. 10 hard drawn phosphor bronze wire, 100 ft..... **\$1.25**

Other lengths in proportion

Summertime is portable time. May we recommend the **WING** Transceiver for automotive use. Many amateurs are getting a 15 mile range with this unit. Price with tubes.... **\$18.25**

The **MALLORY** type 11 power supply is ideal for B supply for the transceiver. Price..... **\$11.50**

V.T.E. 203A tubes carrying our regular guarantee. Special..... **\$9.75**

Heavy Glass Insulators 5" long, Special..... **10c**

The new Sprague line of 600 v. working tubular paper condensers — all standard capacities from .0001 to .01. .15c .02..... **.18c**  
**400 v. working**

.05..... **.18c** .1..... **.21c**  
 .25..... **.27c** .5..... **.36c**

### AEROVOX

Mica Condensers at new low prices.

1460 — 40 mmf to 100 mmf..... **.9c**  
 150 to 500..... **.12c**  
 .001..... **.15c**  
 .002..... **.21c**  
 1450 — 50 mmf to 500 mmf..... **.15c**  
 .001 to .0015..... **.18c**  
 .002 to .0025..... **.21c**  
 .005..... **.27c**  
 .01..... **.42c**

### RESISTOR SPECIAL!

The product of one of the country's largest manufacturers. 200-watt Vitreous enamel resistors 8½" long, furnished with slider.

1000 ohm	<b>\$ .85</b>	25,000 ohm	<b>\$1.10</b>
2500 ohm	<b>.95</b>	35,000 ohm	<b>1.15</b>
5000 ohm	<b>.95</b>	50,000 ohm	<b>1.20</b>
10,000 ohm	<b>1.00</b>	60,000 ohm	} <b>1.25</b>
15,000 ohm	<b>1.05</b>	80,000 ohm	
		100,000 ohm	

We are the only regular *QST* advertiser in New York carrying the nationally known lines listed below. Manufacturer's bulletins will gladly be mailed on request, together with our lowest special prices.

General Radio	National	Lynch
Acme Delta	Tripplett	Birnbach
Weston-Jewel	Readrite	Sprague
Amertran	Aerovox	Flechthelm
Hygrade Sylvania	Cornell-Dubilier	

### QST—OVERSEAS AMATEURS QST

Since our original announcement in November, 1933, *QST* describing our export plan, our shipments to all corners of the globe have shown a gratifying increase. Free packing properly done is only one of the many features appealing to our DX friends.



45 Vesey Street, New York City  
 New York Headquarters for Transmitting Apparatus

# Sylvania

## TYPE 830-B



# 10<sup>00</sup>

The Sylvania 830-B is a tube especially designed for class "B" audio use. It is an exceptionally fine tube for use in class "B" modulator positions, where audio outputs of the order of 200 watts are desired. This tube can also be used as an R. F. amplifier capable of 60 watts output. The plate lead coming out through the top of the glass envelope allows for the use of plate voltages up to 1250 volts maximum. Filament heating requires 10 volts at 2 amperes. Write for Engineering Information.

## HYGRADE SYLVANIA CORPORATION

ELECTRONICS DEPARTMENT  
AMATEUR RADIO DIVISION  
CLIFTON, N. J.

FACTORIES:

EMPORIUM, PA.  
SALEM, MASS.



ST. MARYS, PA.  
CLIFTON, N. J.

such signals. Hand capacity is absolutely absent.

The cost? Well, figure it out for yourself. It can readily be kept to half or less than that of a commercial receiver of equivalent grade and performance, if one's own time is not considered.

On this occasion of the twentieth anniversary of the founding of the A.R.R.L., the writer cannot help but compare the receiving equipment he was using at the time with that available to-day. The deForest audion "bulbs" were just becoming available—and an amateur was indeed lucky to obtain one. But since regeneration or any kind of high amplification was unknown to amateurs at large, the new "bulbs" were little more effective than the older silicon or galena detectors. A very pleasant remembrance is that of experiments conducted with President Maxim in endeavoring to squeeze out a little more signal from the receiver by using an antenna several hundred feet long and applying a magnetic field to the audion.

What a difference between the scattered array of loose-couplers, loading coils and condensers of that time and the selective, compact receivers of to-day! And yet the same friendly "ham" spirit and coöperation that existed then still lives. May it ever be so.

### 500-Watt Transmitter

(Continued from page 63)

connected in series with the 110-volt leads to the first key-switch and operates as a main line switch. (In remote-control operation the switches on the front panel must be in the closed position.) The other two wires are used to operate the keying relay, the contacts of which key the center tap of the third stage. In series with the keying contacts are three keying tubes, used to eliminate key clicks as far as possible, and also relay  $RY_2$ , a very sensitive relay having a resistance of 2300 ohms. Across the winding of  $RY_2$  are connected a 1000- $\mu$ fd. condenser,  $C_{20}$ , and a 5000-ohm variable resistor,  $R_{10}$ , to give a time delay in the opening of  $RY_2$  after the key is opened. The magnitude of the time delay can be adjusted over a range of one to nine seconds by the setting of the resistor. The contacts of  $RY_2$  are connected in series with the winding of  $RY_3$ , which is operated from a storage battery. The contacts of  $RY_3$  are connected in series with the 110-volt line and the three plate key switches. When the key is closed at the control point, the keying relay,  $RY_1$ , operates and closes the time-delay relay,  $RY_2$ , which in turn closes the plate-switch relay,  $RY_3$ , supplying 110 volts to all plate transformers. The time-delay relay will hold the plate relay closed during keying. Relay  $RY_2$  acts as a protective self-biasing resistor for the single 511 stage to prevent excessive plate current flow in case of loss of excitation, and also acts in conjunction with the keying tubes as an additional protective device. For instance, if the key should be put inadvertently in the closed position before the main line switch,  $SW_2$ , is closed, the tubes in the transmitter would not be damaged on closing  $SW_2$  because  $RY_2$

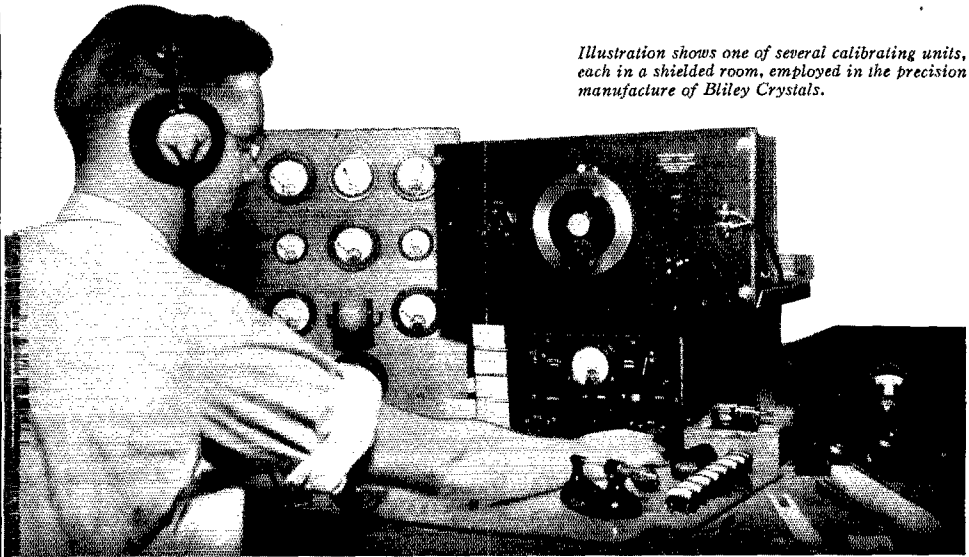
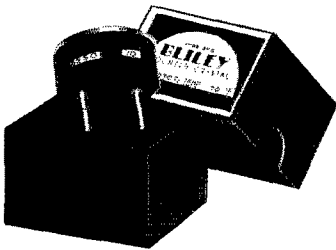

Illustration shows one of several calibrating units, each in a shielded room, employed in the precision manufacture of Bliley Crystals.

## The Price of Precision



BC3 UNIT

**IT COSTS** to build quality into any product — a cost in money, experience, equipment, human effort and strict adherence to an ideal. Yet the reward of public acceptance, always accorded honest endeavor, justifies the expense. The Bliley Crystal is a quality product.

Bliley Crystals are machined to a definite, exacting, never-wavering high standard of precision. Only the finest of materials, in the hands of skilled workmen, are used in their manufacture. And, as final check, they are subjected to the exacting eyes of the most modern testing equipment. Only after measuring up to the most rigid tests, do they receive the Bliley stamp of approval, and go out to you under the Bliley label and guarantee.

Let's look at the

### BLILEY BC3 MOUNTED CRYSTAL

BLILEY CRYSTALS AND HOLDERS					
Type	Mc Band	Supplied Within	Precision	Furnished	Price
BC3	1.7, 3.5, 7.0	±25Kc*	0.03%	Mtd.	\$4.95
BC3	1.7, 3.5, 7.0	±5Kc	0.03%	Mtd.	5.75
BC3	1.7, 3.5, 7.0	Exact	0.03%	Mtd.	6.85
BC5	100 Kc Std.	Exact	0.05%**	Mtd.	9.50
BC6	1.7, 3.5 or 7Mc holder-oven for BCX				7.50
SSF	465, 500, or 525Kc.S.S. Qlz filter, Mtd.				5.90

\*Or your choice from distributor's stock.  
 \*\* Adjustment by purchaser will greatly reduce this.  
 Crystals manufactured between 20 Kcs and 15 Mcs

Here is a crystal designed primarily for the amateur who wants a crystal complete in a unit, ready to plug into his transmitter. It is of the X-cut power-type; mounted in a compact molded bakelite holder; and maintains single-frequency oscillation. It gives less frequency drift while warming up—greater power output—and keeps the transmitter LOCKED on one chosen frequency—a characteristic of ALL Bliley Crystals. And yet for this precision product—this better crystal—you are asked to pay only.....

**\$4.95**  
See price table

Bliley Crystals may cost you a little more but they're worth the difference. Sold by all progressive distributors of amateur equipment—and if your distributor doesn't have your choice in stock, he can get it for you quickly.

See our display at 1934 World's Fair Radio Amateur Exhibit



**BLILEY PIEZO-ELECTRIC CO.**  
 208 Union Station Bldg. ERIE, PA.

# Sylvania

## TYPE 866-A



# 5<sup>00</sup>

The Sylvania 866-A is a shielded filament type mercury vapor rectifier. It is made especially for use in transmitter power supplies. The shielded filament allows stability of operation, higher cathode efficiency and minimizes the possibility of R. F. within the tube. A graphite anode is utilized. The low and constant internal voltage drop gives an ideal rectifier, where high efficiency is the main requisite. Write for Engineering Information.

## HYGRADE SYLVANIA CORPORATION

**ELECTRONICS DEPARTMENT  
AMATEUR RADIO DIVISION  
CLIFTON, N. J.**

FACTORIES:

EMPORIUM, PA.  
SALEM, MASS.



ST. MARYS, PA.  
CLIFTON, N. J.

cannot operate until the filaments of the keyer tubes reach normal temperature, since the current for  $RY_2$  must flow through these tubes. It is impossible for the plate relay,  $RY_3$ , to close, so long as  $RY_2$  is open.

The storage battery which energizes  $RY_3$  and  $RY_4$  is kept charged at all times by a charger of the type once popular for battery-operated broadcast receivers, which is equipped with a relay to place the battery on charge when it is not delivering current. The relay of the charger is connected in series with  $RY_4$ . When the transmitter is in operation the battery charger is automatically turned off, and when the transmitter is not in operation the battery charger returns to its normal charging position.

#### GENERAL CONSTRUCTIONAL FEATURES

All meters are connected to two-wire cables with lugs on each end. Two small insulators mounted on the front edge of each baseboard serve as meter connections. Each dial has a small shaft and flexible coupling connecting it to the condenser. The switches, signal lights and primary rheostats are wired on the panel with their lead wires brought out to terminal strips located on either side of the panel. Cables then connect these strips to the terminal strips mounted on each power-supply board. These features make the panel easily detachable. The baseboards are held to the metal shelves by a single bolt provided with a thumb nut. Excitation leads terminate on small stand-off insulators. At the lower left side of the cabinet (Fig. 4) just below the baseboard is a terminal strip to which is connected a cable leading to the relay box and the main 110-volt line, and also the two wires which connect to the keying relay. The keying tubes and all relays except those for keying and charging are housed in a metal box placed on a table near the transmitter.

Each plate milliammeter is fused by a Littelfuse for protection not only of the meters but the tubes as well, in case of overload. Both sides of the 110-volt line are fused with 10-ampere fuses—which, incidentally, have already proved their value when filter condensers have blown.

#### TRANSMITTER OPERATION

Ordinarily the input to the final stage is in the vicinity of 450 watts on all three bands. For the benefit of those who may be considering a similar tube line-up, the grid and plate currents to the various stages may be of interest. The actual measured voltages are indicated in the r.f. circuit diagram, Fig. 3.

Because of the way in which the oscillator is constructed, the milliammeter in this stage measures the total current taken by the plate, screen and the voltage divider. This total current is approximately 70 milliamperes on both 3.5 and 7 mc. The grid current on the 10 buffer stage is approximately 12 ma. and the plate current 70 ma. on both bands. The 511 buffer stage averages 35 ma. grid current and 100 ma. plate current on all three bands.

As might be expected, the grid current in the

# NEW

## THORDARSON Transmitter and Power Amplifier

Again THORDARSON achieves  
a great advancement in Transformer  
design — "AIR-COOLED"

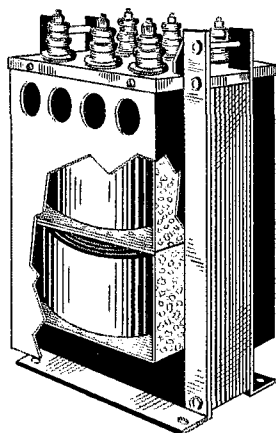

Every pound of weight in these new transformers is utilized electrically. Useless castings and compound fillings are eliminated by this exclusive "air-cooled" design.

Vacuum impregnation with varnish over coating provides permanent protection, yet assures constant low operating temperatures, because the windings are provided with continuous air circulation through air ducts.

All voltage and current ratings are actual D.C. out of suitable filter, not meaningless A.C. ratings.

Write for the new THORDARSON descriptive price list.

# GUIDE

New CIRCUITS — New TUBES  
New TRANSFORMERS

— the newest and most complete data on recent developments in transmitting and power amplifier circuits!

Introduces the greatly expanded THORDARSON Transformer Line that now includes equipment for every power need and every coupling need — in the most modern circuits employing the latest type tubes.

Get your copy today! Free with a THORDARSON order from your jobber, or send ten cents to cover postage and mailing.

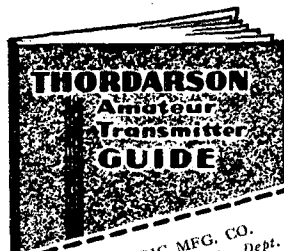

THORDARSON ELECTRIC MFG. CO.  
500 W. Huron St.—Chicago, U. S. A., Dept. B

Please send me: [ ] THORDARSON GUIDE  
(10 cents enclosed) [ ] THORDARSON Catalog Sheet (No charge)

Name.....

Address.....

# THORDARSON

Electric Mfg. Co.  
500 West Huron St., Chicago, Ill.

Order for the New THORDARSON Transmitter Guide

# Sylvania

## TYPE 212-D

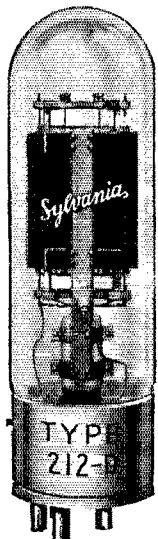

# 75<sup>00</sup>

The Sylvania 212-D is especially desirable as a class "B" or "C" power amplifier, and it is also very good as a modulator. Conservatively speaking, it will completely modulate inputs to class "C" finals up to 200 watts. As an R. F. Amplifier, an output of 250 watts is obtained with 1500 volts on the plate. When used for CW transmission, higher plate voltage may be used, up to 2000 volts maximum, with greatly increased R. F. output. A graphite anode is used which allows greater plate dissipation with longer life and high vacuum throughout the life of the tube. Mechanical ruggedness, mesh grid, thoriated tungsten filament, and a ring seal make this Sylvania 212-D the outstanding tube of its type today. Write for Engineering Information.

## HYGRADE SYLVANIA CORPORATION

### ELECTRONICS DEPARTMENT AMATEUR RADIO DIVISION

CLIFTON, N. J.

FACTORIES:

EMPORIUM, PA.  
SALEM, MASS.



ST. MARYS, PA.  
CLIFTON, N. J.

final push-pull 511 stage varies with the frequency. On 3.5 mc., where all the preceding stages are on the same frequency, the grid current is 125 ma. with the amplifier fully loaded (400 ma. at 1200 volts, or 480 watts input). On the 7-mc. band the grid current is 90 milliamperes with the same plate input. As normally operated on 14 mc., the plate input is 350 ma. at 1200 volts, and the grid current 50 ma. On none of these bands is the amplifier pushed to its full capabilities, since the plate-spacing in the plate tank condenser now in use is not great enough to hold the r.f. voltage developed when more than 1200 volts is used on the plates. One of the items on the list of alterations to be made at a later date is the installation of a final-stage tank condenser of higher voltage rating so that higher plate voltage can be used.

The subject of alterations brings to mind one of the really valuable features of the transmitter. With new circuits, new tubes, and all kinds of improvements constantly coming along, no transmitter ever can be considered to be the final thing—a new rig is no sooner finished than something better is developed. As anyone reading this description readily can see, the design of this transmitter leaves plenty of opportunities for changes as the art progresses. But it is unlikely that the whole outfit would have to be rebuilt, and even less likely that the appearance of the set would have to be changed. Since appearance counts for a lot with the enthusiastic amateur, it is comforting to know that one can have a good-looking set without the least fear that its electrical features cannot be kept up to date.

### Visit the Clubs

A GOOD many hundred amateur radio clubs throughout the United States and Canada are affiliated with A.R.R.L. At headquarters we have recorded the addresses of these clubs, their places and times of meeting. Clubs are splendid places to get acquainted with other amateurs and to participate in interesting discussions on amateur radio. Do you want to be put in touch with a club in your vicinity? Would you like to attend a club meeting in another city you are visiting? Address the Communications Manager (enclosing 3¢ stamp, please) for data on Affiliated Clubs in your vicinity.

### Technical Progress

(Continued from page 27)

wants to build a real spark transmitter and doesn't know how. C.w. is a fine thing and will not be neglected in *QST*, as we sincerely believe the ultimate relay station will be operated with c.w. But at the present, 99% of our relay work is being handled by spark and it behooves us to give the spark station more consideration."

Here we run into a period full of significant events. In *QST* for February, 1921, P. J. Furlong,

# CELEBRATE THE LEAGUE'S 20TH ANNIVERSARY WITH US — APRIL SALE CONTINUED

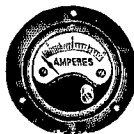

## Hoyt Antenna Meter

Hot wire antenna meters, 2 3/4" mounting hole, flange 3" diameter, supplied in 1 1/2, 3 and 5 ampere ranges. Why work without antenna meters when you can buy them at this special price?.....\$2.95

## Hoyt Milliammeters and Voltmeters

Perfectly damped meters at a price. These are not to be confused with the usual inexpensive meters. 2" mounting hole, flange 2 3/4" diameter, supplied in the following sizes: 10 ma., 25 ma., 50 ma., 100 ma., 150 ma., 250 ma., 300 ma., 4 V. AC, 10 V. AC, 15 V. AC, 10 V. DC. Price each \$1.30, 3 for \$3.60.

## GROSS CRYSTAL HOLDER ONLY \$1.00

A commercial type crystal holder for half the price you have to pay for ordinary holders. New type pressure spring, square inside to prevent movement of crystal, one piece molded body — dustproof — will take crystals up to 1 1/2" square or round. Plus standard 3/4" spacing. This holder must be seen to be appreciated for the extraordinary value offered.

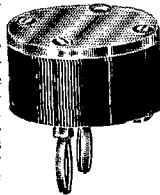

## Ward Leonard Vitreous Resistors 200-Watt 8 1/2" Long with Variable Sliders.

1000 ohms.....	\$ .93
2500 ohms.....	.99
5000 ohms.....	.99
10000 ohms.....	1.05
15000 ohms.....	1.10
25000 ohms.....	1.17
35000 ohms.....	1.21
50000 ohms.....	1.29
60000 ohms.....	1.29
80000 ohms.....	1.29
100000 ohms.....	1.29

## ELECTRAD 50 watt Vitreous Enamel Res.

10 to 5000 ohms.....	\$ .39
6000 to 50,000 ohms.....	.49
60,000 to 100,000 ohms.....	.59

## NEW! UNIVERSAL Stretched Diaphragm Type, 1934 MODEL "X" double button.....\$5.88

## MIDGET DOUBLE SPACED NEUTRALIZING CONDENSERS 35 mmf. — a real buy.....\$5.99

Pilot J-23 100 mmf. condensers..... .55

## JOHNSON Transposition Insulators, \$ .09

Airplane Strain Insulators.....	.05
12" Antenna Insulators.....	.45
White or black 1/2" and 1" Stand offs, doz.....	.50
White or Brown Beehive Ins., doz.....	.45
Isolanite spreaders 3" long, 10 for.....	.35
X cut 80 or 160 M Crystals.....	\$2.35

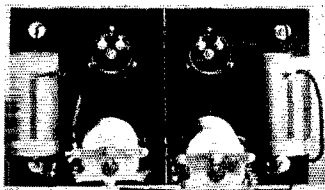

## Universal Antenna Coupling System Inductances

Wound on threaded double X natural bakelite tubing, can easily be tapped with clip supplied, ea.....\$1.75 (use one coil for single-wire feed and two coils for two-wire systems)

## Universal Antenna Tuning Unit

Complete kit of parts for outputs up to 50 watts.....\$13.95

## Low C 80-160 Meter Amp. Coils

Plug-in, wound on threaded tubing, will tune with 50 or 75 mmf cond. either size, ea.....\$2.00

## AM-2 New!! HAIGIS TRANSCEIVER \$17.40

Portable 56 to 60 megacycle transmitter-receiver combination — built-in I.C.W. — uses one 30 and one 33 tube — housed in portable metal case, baked black wrinkle enamel finish — weighs 7 pounds — 7 1/2" square by 5" deep — the most efficient job of this type we have seen yet. Book of instructions for installation and operation furnished.

## GUARANTEED TUBES

Gross 210 Thoriated filament.....	\$1.49
866 Heavy Duty Isolantite top.....	1.45
888 or 871 Isolantite top.....	.95
83, 47's, 46's.....	.65
81's.....	.80
1/4, 1/2 and 1 watt Neon Bulbs.....	.35

## 510 Type Tube Isolantite Base

Lava bar insulation — Thoriated filament — the kind of tube we like to sell. Will take 750 volts on the plate. Ideal for the higher frequencies. Special.....\$2.59

## HOYT MOVING COIL METERS

0-1 MA 3" wide range meters, Spec.....	\$2.90
Single or double button mike trans.....	\$ .89
Porcelain Base 50 Watt sockets (side wiping contacts brown or white).....	\$ .99

## The "EAGLE" Three-Tube Short Wave Receiver

"Band Spread" over any portion of the tuning range — only finest material used thruout. Employs one '32 R.F., one '32 detector and one '33 Pentode Audio — 15 to 200 meters — four coils supplied. The "EAGLE" is economical — two dry cells will operate the filaments. See March or April QST for full description of this most excellent value in short wave receivers.

"Eagle" completely wired and tested... \$11.95 Three tubes tested in your receiver... \$3.00

A pair of 2000 ohm featherweight phones included in the price for this month only

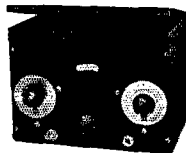

## Cased Combination Filament Transformer

2 1/2 V. C.T. 10 amps for 866's  
10 V. C.T. 7 amps for '50's or '52's  
10000 volts insulation.....\$3.24

## Filament Transformers shielded in metal cases, center tapped secondaries.

2.5 Volt 10 amperes for 866's.....\$2.25  
10 to 12 Volts at 8 amperes.....\$2.25  
Special 10-12 Volt 7.5 ampere filament transformer, extra special.....\$5.95

## Mounted Center Tapped Filament Transformers

2 1/2 v 8 a — 2 1/2 v 3 a — 5 v 3 a.....	\$1.19
2 1/2 v 4 a — 7 1/2 v 2 1/2 a — 7 1/2 v 2 1/2 a.....	\$1.19
2 1/2 v 4 a — 5 v 3 a — 7 1/2 v 2 1/2 a.....	\$1.19
5 v 3 a — 7 1/2 v 2 1/2 a — 7 1/2 v 2 1/2 a.....	\$1.19
2 1/2 v 6 a — CT (midget).....	\$.74
5 v 3 a — CT (midget).....	\$.74
6.3 v 1.5 a — CT (midget).....	\$.69
7 1/2 v 3 a — CT (midget).....	\$.89
4 Section RF Chokes 125 ma — 2.5 mh — 50 ohms dc res. Isolantite form pigtail mounting spec.....	\$3.39

## GROSS CASED POWER TRANSFORMERS

650 v ea. side C.T. 350 ma fila. 2-7 1/2 v C.T. and 1-5 v will give 500 v with choke input using 1-83 or 5Z3. You can run your entire R.F. and class B off this trans.....\$5.50

750 v ea. side C.T. 300 ma fila. 2-7 1/2 v C.T. and 1-5 v.....\$5.75  
750-1000 v ea. side of C.T. 300 watts.....\$6.65

850-1350-1500 v ea. side of C.T. 400 watts.....\$8.70 (the ideal job to give 750-1000-1250 v D.C. with choke input)

850-1350-1500 v ea. side of C.T. 550 ma.....\$12.50  
1500-2000 v ea. side of C.T. 800 watts.....\$11.70

## FILAMENT TRANSFORMER FOR BRIDGE RECTIFIER

using 83 tubes 5v-5v-5v at 3 amps C.T. — 3000 v insulation.....\$2.15

## GROSS CASED CLASS "B" 800 TRANSFORMERS

Husky trans. for coupling to 5000 or 20000 ohm loads. Per pr.....\$9.89

## GROSS CASED CLASS "B" TRANSFORMERS

Heavy Duty — for use with 10's, 46's or 4-46's in push pull par. per pr...\$6.60  
For 2-46's only, per pr.....\$4.65

THORD. Cased Class B 210 Trans. T 5100 Input.....	\$2.94
T 5101 Output.....	\$3.55
Thord. 15 H 250 MA chokes.....	\$2.95
Thord. 30 H 500 MA chokes.....	\$8.95
Gross 30 H 200 MA cased chokes.....	\$1.94

HIGH QUALITY CASED COND. 2 mfd 2000 V. working.....\$3.95  
2 mfd 1000 V. working.....\$2.10

New! HAMMARLUND Heavy Duty Transmitting Chokes 2.5 mh — 8 ohms dc res. 500 ma.....\$1.05

20% deposit with all C.O.D. orders. Remit by M.O. Include postage

GROSS RADIO, INC.

51 VESEY STREET

NEW YORK CITY

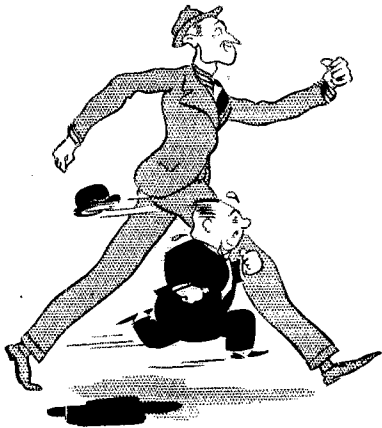

## "the LONG & SHORT of it"

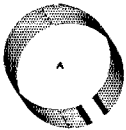

Resistor A used in the new Radiohm, has the same length path across its entire width, giving greater effective area for good volume control.

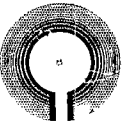

Resistor B of an annular shape, has long been the standard type. Current concentrates around the INNER edge, i.e., the shortest path.

A longer resistance path means more gradual attenuation, i.e.: a more efficient volume control. The new CENTRALAB RADIOHM now available for all replacement jobs is easily twice as efficient as the old style volume control.

The next time you replace a volume control . . . use a CENTRALAB RADIOHM and begin to take inventory of the "satisfied customers." . . . You'll find a new satisfaction in this better (yet smaller) RADIOHM now made in 1 3/8 in. diameter size for the smallest chassis. Change today to RADIOHMS. . . .

Your Jobber has the new  
**1934**  
**VOLUME CONTROL**  
**GUIDE. Get it . . .**  
It's free

**Central Radio**  
**Laboratories**  
MILWAUKEE WIS.



# Centralab RADIOHM

1FF, described a method of using electrolytic rectifiers in a high-voltage supply system that eliminated the need for a motor-generator. In March, the UV-202 five-wattter was announced. In June, the Reinartz c.w. tuner was described, and in July, Heising's article on plate modulation (the first authoritative dope on the subject) was presented. These four developments, as we see it now, had a tremendous influence in establishing the tube transmitter as eminently practical and valuable equipment for the amateur.

### HAVE WE CHANGED?

But *QST* still had a fight on its hands. The publication of information on c.w. seems to have established *QST* as having a rabid anti-spark attitude. An editorial in the September 1921 issue is good for a laugh now though it was not at that time! "Certain of our friends," it runs, "have pointed out to us that we are in danger of starting an unprofitable controversy between the Spark and the C.W. These friends, endeavoring to view the matter unprejudicedly, cannot agree that we have been quite fair to the Spark. . . . we recognize the merit of the sparks and do not want to be considered ever as throwing mud at them. We want the C.W. to win, if it can, on merit. Good-natured rivalry is a healthy sign, we think, but we hope that absolute fairness, real sportsmanship, and coöperation will characterize the work of A.R.R.L. members. We are in trying days, with legislation pending and with the financial situation affecting our manufacturers and we don't want a row that will divide us into two camps, who will conduct jamming contests or engage in verbal battles."

The spark men had to take a jolt when c.w. transmitters turned in the superior performance during the Transatlantic Tests of December, 1921. But it was to be more than a year later when spark at last ceased its death struggles. During the second Transatlantic Tests, in December, 1922, spark was a total failure.

From its slow post-war start, amateur radio, from the technical angle, had been gaining momentum slowly but quite definitely. Now, with the spark debris cleared away, the road was open.

An editorial in March, 1923, *QST*, contains an early hint of the tremendous revolution in short-wave work which was about to break. Under the title, "A New Field," it said: "Have you ever noticed what a narrow escape 200 meters has from being the lowest amateur wavelength instead of the highest? If you want to find blank silence, listen anywhere below 180 meters.

"Notice we said 'almost.' It isn't quite blank and it's liable to grow rapidly less so as a result of some very interesting experiments now in progress among a group of amateur stations. . . . Do you know that 100-meter transmission between Illinois and Connecticut is proving FB? It is! . . . We'll have data in *QST* soon."

The opening of 1924 saw the first transatlantic two-way working; and before the end of the year, all the territory down to 5 meters had received



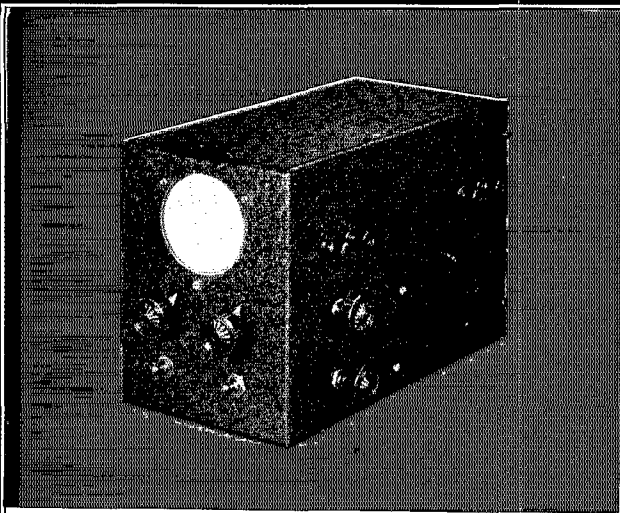

**P E R C E N T  
M O D U L A T I O N**

—?—

**R. F. S I G N A L  
D I S T O R T I O N**

—?—

**C L A S S C A M P.  
E X C I T A T I O N**

—?—

## **CATHODE RAY OSCILLOSCOPE**

Providing an instantaneous graphic picture of the actual operating conditions in transmitter circuits, the Cathode Ray Oscilloscope gives important information not readily obtainable by other means. Percentage Modulation, Signal Distortion and Peak Voltages, for instance, are indicated directly, and results are easily interpreted.

The National Oscilloscope is similar to that described in April Q.S.T. The Cathode Ray Tube is the 3-inch diameter RCA-906. No linear sweep device is provided, as it has been found more desirable to use an audio signal from the transmitter for this purpose. The resulting "trapezoid pattern" may be interpreted more readily, and percentage modulation more easily calculated, than with a linear sweep. However, the linear sweep may be added at any time if it is found necessary for special work.

The unit is entirely self-contained, the power supply and control devices being built-in. The dimensions of the cabinet are 12" x 8" x 6", exclusive of knobs and binding posts. The catalogue symbol is Type CRO, the List Price \$29.50 without tubes (RCA-906 and 80)

*Usual Discounts Apply*

**NATIONAL**  
61 SHERMAN STREET



Established 1914

**COMPANY**  
MALDEN, MASS.

Examine these  
recent  
**McGRAW-HILL**  
BOOKS  
in the field of  
**Radio**  
for 10 days on approval

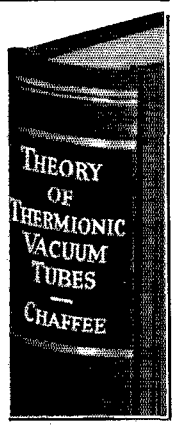

**1. RADIO ENGINEERING HANDBOOK**

Editor-in-Chief, Keith Henney, of *Electronics*. Handbook of radio comparable to standard manuals in other fields of engineering. Emphasizes design; covers everything from fundamentals to latest practical applications; includes new tubes and circuits, Class B Amplifiers, short-wave, television, sound pictures, aircraft radio, etc. 583 pages, \$5.00.

**2. ELECTRONS AT WORK**

By Charles R. Underhill. Scientifically accurate and reliable, yet a practical, understandable treatment. Tells what electrons are, how the various tubes and cells function in harnessing them, and how these devices are applied in industry and biology. 354 pages, \$3.00.

**3. RADIO ENGINEERING**

By Professor F. E. Terman of Stanford University. Comprehensive engineering treatment of important vacuum-tube and radio phenomena. Analyzes circuits and tubes and reduces them to quantitative relations predicting performance with accuracy and certainty. 750 pages, \$5.00.

**4. THEORY OF THERMIONIC VACUUM TUBES**

By Professor E. Leon Chaffee of Harvard University. Comprehensive treatment of fundamentals of thermionic emission and the vacuum tube. Covers use of tube as amplifier and detector as well as its general properties. New, original material on large-signal regeneration, regeneration in coupled circuits, detection, amplifiers, etc. 652 pages, \$6.00.

**5. RADIO OPERATING QUESTIONS AND ANSWERS**

By Arthur R. Nilson and J. L. Hornung. Gives nearly 600 questions typical of those presented in license examinations, covering broadcasting, marine, aeronautical, police and amateur radio operating, with full, practical, illustrated answers. Includes latest types of equipment, new radio laws, etc. 389 pages, \$2.50.

Send this coupon

McGRAW-HILL ON-APPROVAL COUPON  
McGRAW-HILL BOOK CO., Inc.  
330 W. 42nd St., N. Y. C.

Send me books checked below for 10 days' examination on approval. In 10 days I will pay for those I keep, plus few cents for postage and delivery, and return rest postpaid. (We pay postage on orders accompanied by remittance.)

Henney — Radio Engineering Handbook, \$5.00  
 Underhill — Electrons at Work, \$3.00  
 Terman — Radio Engineering, \$5.00  
 Chaffee — Theory of Thermionic Vacuum Tubes, \$6.00  
 Nilson and Hornung — Radio Operating Questions and Answers, \$2.50

Name .....  
 Address ..... Position .....  
 City and State ..... Company ..... QST-5-34  
 (Books sent on approval in U. S. and Canada only)

attention. This was the beginning of the DX era—the period during which the extraordinary capabilities of the short waves for long distance communication were revealed to the world. A steady stream of technical developments provided the background for the years 1924 and 1925, but they were characterized chiefly by the tremendous operating activity and the mastery of all terrestrial distances.

By this time, the amateur game was in top gear and travelling at a terrific pace. Starting years and years behind the professional world after the war, it had gradually gained enough momentum to carry it far ahead. For the first time in radio history the amateur led the game. The commercial world of radio manufacturers, gleeful over the potentialities of broadcasting, had forgotten him. As a result, the best ham equipment of those and many succeeding years was ham-built.

The story of the years since 1925 is one of continuous and really quite extraordinary technical development. World-wide amateur communication having become mere routine, the attention of experimentally inclined amateurs naturally turned to the development of new and refined technique and equipment. The pressing need for restriction of the territory occupied by transmitted signals and for the improvement of receiver selectivity resulted in a rising tide of development work which has climbed to tremendous proportions and carried the amateur with it to an even higher plane in the technical world. It would be quite absurd to attempt to survey these years of development in detail. It is perhaps permissible, though, to find some pleasure in the knowledge that A.R.R.L. and *QST's* contributors, through their technical activities, have lifted the radio amateur from the status of a slow-moving imitator of the professional worker to that of technician in his own right evolving superior equipment to suit his own needs.

To-day, the commercial manufacturer has found time to return his attention to the amateur field. As a result, superlative amateur equipment can be purchased more readily than it can be built at home. But the amateur maintains his lead. To-day's commercial manufacturer of amateur equipment is pleased to lean heavily on the developments presented by A.R.R.L. for his technical inspiration—a condition just as logical as it is mutually beneficial.

Today, the amateur has provided himself with equipment which, if we had not learned the lessons of the past, we would certainly consider the ultimate. The enormous growth of amateur radio has been paralleled by brilliant technical advance. Notwithstanding the occupancy of our bands by hordes of amateurs the world over, the present technique has resulted in a closer approach to a solution of the QRM problem to-day than at any other time during the last fifteen years. Never before have we enjoyed the wealth of reliable and consistent international communication which characterizes this era.

We have come far. We are going further.  
—R. A. H.

# KENYON DREADNOUGHT LINE

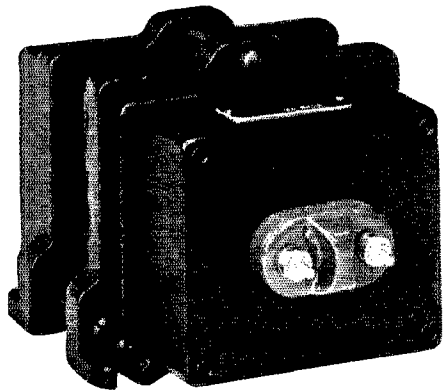

For increased efficiency . . . greater range on regular schedules . . . modulation that will gain listeners . . . a station to be really proud of—simply specify or use these superior components. Formerly built to order for commercial services; now in regular production to sell at ham-pocketbook prices.



## Filter Reactors

Typical of this line and rounding out advantages gained by using Dreadnought grade input and output transformers, plate supply and filament transformers. Featuring:

1. New end castings.
2. High insulation factor.

3. Poured compound, dissipating heat more efficiently than usual air.
4. Porcelain bushings on all high-voltage terminals.
5. Built for continuous, heavy-duty reliable service.
6. Typically Dreadnought grade—rugged, oversized, advanced design, true craftsmanship.

### FILTER REACTORS (Swinging) For Use in First Stage of Filter

Type No.	Inductance Range	D.C. Range	Max. D.C. Voltage	Ohms	Test Voltage	Weight (lbs.)	Case	List Price
TR-3025A	5.5-23	0.50-0.07	1,000	55				
	22-92	0.25-0.03	2,000	220	6,000	33	1B	\$25.00
TR-1220A	6.5-37	0.20-0.04	1,250	85	3,500	13	3B	12.00
TR-9400A	5.5-22	0.40-0.06	1,250	50	3,500	20	2B	19.50
TR-1025A	7.0-28	0.25-0.05	750	85	2,500	13	3B	12.00
TR-9180A	6.0-23	0.18-0.025	500	105	2,500	9	LC-3	9.00

The above reactors are to be used as input reactors and should not be used in circuits whose D.C. voltage exceeds the values given in the table. These reactors, in combination with those given on Table No. 2, represent the most economical use of materials to obtain entirely satisfactory filter operation.

### FILTER REACTORS (Smoothing) For Use in Subsequent Stages of Filter

Type No.	Henries	D.C.	Ohms Resistance	Test Voltage	Weight (lbs.)	Case	List Price
TR-3025	35 Series	.25	220				
	8.5 Parallel	.50	55	6,000	33	1B	\$25.00
TR-1220	12	.20	85	3,500	13	3B	12.00
TR-9400	8	.40	50	3,500	20	2B	19.50
TR-1025	10	.25	85	2,500	13	3B	12.00
TR-9180	8.6	.18	105	2,500	9	LC-3	9.00

All inductances specified are those obtained with rated D.C. flowing in the windings, under conditions of actual filter circuit operation. The reactors are so designed as to give the most economical use of materials for a given inductance.

## RECTIFIER CIRCUIT DATA

Combination	Tube Application	D.C. From Filter		Recommended Bleeder Resis.	Power Transformer	Reactors	
		Volts	Amperes			First	Second
A	RK-18, 800	1,000	0.250	60,000	TPA	TR-3025A	TR-3025
	825, 03A, 11	1,000	0.500				
B	RK-18, 800,	1,250	0.20	25,000	TPB	TR-1220A	TR-1220
	825, 03A, 11	1,000					
C	RK-18, 800	1,250	0.40	17,000	TPC	TR-9400A	TR-9400
	825	1,000					
D	800, 10,	750	0.25	20,000	TPD	TR-1025A	TR-1025
	841, RK-18	600					
E	46, 5, 9,	500	0.18	17,000	TPE	TR-9180A	TR-9180
	10, 841	400					

The filter circuit is the standard two section filter, using reactor input, with 4 microfarad condensers after the first and second reactors. Voltage ripple is, in all cases, better than 0.2% of the direct voltage. Voltage regulation, from full load to bleeder load, will not be in excess of 10%.

For immediate data on other components of this line, see March, April and May issues of *QST*. If interested, write for full particulars and bulletin. Your nearest amateur radio supply house has these components now on display and in stock for your inspection and immediate requirements. Supplied at usual amateur discounts.

TO JOBBERS AND DEALERS: This line is being sold through a select group of merchandisers in exclusive territories. Some territories still open.

Write for proposition

**KENYON TRANSFORMER Co., Inc.**  
122-124 Cypress Avenue :: :: New York City



# RCA FULL RANGE TEST OSCILLATOR

TYPE TMV-97-B

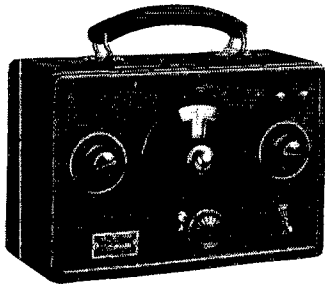

The type TMV-97-B Test Oscillator is a compactly constructed, self-contained modulated R.F. oscillator designed primarily for service work in conjunction with all types of radio receivers.

Proper servicing of the simplest receivers is impossible without a well designed oscillator. New receiver designs covering an increasingly higher frequency range make the use of such an oscillator imperative. The TMV-97-B oscillator fills the need for such apparatus at a price heretofore considered impossible.

Of special interest to amateurs and experimenters is the simplicity with which the modulation may be eliminated. This may be done by use of a special adaptor in the modulator socket. The oscillator then may be used as a heterodyning oscillator, for short-wave superheterodyne receivers or to adapt standard broadcast receivers for amateur use.

## SPECIFICATIONS

**Circuit** — A tuned grid, plate modulated circuit is used which gives good stability over a wide range of voltage and climatic conditions. The output is modulated approximately 50% at 400 cycles.

**Radiotrons** — Two Radiotrons RCA-30 are used, one as an R.F. oscillator and one as an A.F. modulator.

**Batteries** — One 22½ volt "B" and one 4½ volt "C" batteries are used.

**Size** — Height, 8½ inches (including raised handle), case alone 6½ inches, Width 9¾ inches, Depth 4½ inches.

**Weight** — 3½ lbs. including batteries.

**Frequency range** — 90 K.C.—25000 K.C. by eight steps. The Range Switch is located on the front panel.

**Output** — Two binding posts on the front panel together with an attenuator give an easy means of connecting and adjusting the output.

**Calibration** — The dial is calibrated directly in frequency which is accurate to ± 3%. Individual calibration may be obtained at an additional cost of \$5.

**Case** — The entire oscillator is enclosed in a black wrinkle-finished aluminum case.



**NET PRICE \$33.50**

with Radiotrons — less batteries

ORDER THROUGH NEAREST

RCA VICTOR DISTRIBUTOR OR DIRECT FROM

**RCA VICTOR CO., INC.**  
CAMDEN, N. J., U. S. A.

## Hudson Division Convention

May 24th, 25th and 26th, Hotel Pennsylvania, New York City

THERE will be many outstanding features at the Ninth Annual Hudson Division Convention, which returns to its old home, the Hotel Pennsylvania. Short-wave exhibit of receiving and transmitting equipment, technical talks by prominent speakers, contests, club stunts, prizes and a banquet are all on the program. The fee for the three days, including banquet, is \$3.00. For those who do not wish to attend the banquet, a daily admission fee of 25 cents will be available. A cordial invitation is extended to all within and outside the Division to attend. Write S. M. Riccobono, Chairman, 4305 Church Ave., Brooklyn, N. Y.

## A De Luxe S. S. Receiver

(Continued from page 45)

the pins if the insides of the pins are cleaned by drilling out the hole slightly larger for an eighth of an inch or so.

### TESTING PROCEDURE

Detailed description of the procedure of testing this type receiver was given in the original article,<sup>1</sup> and is covered in the latest *Handbook*. We will briefly outline the method used for this receiver.

The rectifier circuit should first be tested. Using a high-resistance voltmeter, check all plate, screen-grid and cathode circuits for approximate voltage, remembering that the voltages read are not the actual operating voltages. Next insert all the tubes and repeat the test. With the volume control set half way out and  $SW_2$  set to the "CW" position, the voltages from the ground (chassis) should be approximately as follows: To cathodes of pre-r.f. and i.f., 15 volts; to cathode of first detector, 5 volts; to cathode of second detector, 18 volts; and to audio cathode, 16 volts. Voltages at the 57 and 58 screens should be approximately 100 volts, with the exception of the b.o. screen. The 2A5 audio screen has the full plate voltage applied. Nearly full plate voltage will appear on the other plate terminals. The voltage on the b.o. plate and screen-grid is low due to the large value of plate-dropping resistor used.

After the continuity test for voltages, the i.f. should be lined up. All tuning should be done by meter if possible, since with so many circuits a slight mis-tuning on each would affect the overall gain and selectivity considerably. To line up the i.f. end, switch  $SW_2$  to the 'phone position (b.o. off) and throw the crystal switch to short the crystal. Connect a 0-1 d.c. milliammeter in series with the 'phones (the high resistance voltmeter can be used on the lowest voltage scale). Rig up an oscillator working at the i.f. frequency. This can well be a crystal oscillator using the i.f. filter crystal. The oscillator is coupled to the last i.f. tube by hooking an insulated wire over the grid terminal of the tube and running it to the oscilla-

# Have You These Supplies On Hand?



## THE LOG BOOK

Bound with heavy paper covers.  $8\frac{1}{2} \times 10\frac{3}{4}$ . Contains 39 log pages, and same number of blank pages for miscellaneous notes. Also list of Q sigs, message number sheet and sheet of cross-section paper. 40c each or 3 for \$1.00. Postpaid.

## THE MESSAGE BLANKS

Most convenient form. Designed by the Communications Department of the A.R.R.L. Well printed on good bond paper. Size  $8\frac{1}{2} \times 7\frac{1}{4}$ . Put up in pads of 100 sheets. One pad postpaid for 35c or 3 pads for \$1.00.

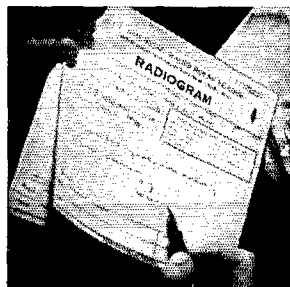

## MEMBER'S STATIONERY

Write your radio letters on League stationery—it identifies you. Lithographed on  $8\frac{1}{2} \times 11$  heavy bond paper. Postpaid. 100 sheets, 50c; 250 sheets, \$1.00; 500 sheets, \$1.75.

## MESSAGE DELIVERY CARDS

Neatest, simplest way to deliver a message to a near-by town. On U. S. stamped postals 2c each. On plain cards (for Canada, etc.) 1c each postpaid.



THE AMERICAN RADIO RELAY LEAGUE—WEST HARTFORD, CONN.

## A SIMPLE CATHODE RAY OSCILLOSCOPE

for checking amateur phones

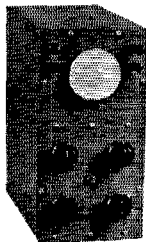

This instrument is a 15" designed primarily for the analysis of trapezoidal figures. As explained in QST.

Complete Kit including all parts—drilled chassis—panel—case—switches—controls—trans.—condensers—nuts—bolts, etc., with assembly and wiring instructions. F.O.B. Newark.....\$20.50  
Tubes: RCA 906.....\$18.00  
281.....2.10  
Wired and Tested with tubes—ready to go.....\$50.00

Linear sweep model for broadcast stations and advanced amateurs, physics labs., etc.

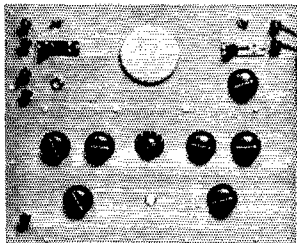

This instrument embodies all features ordinarily contained in only the highest priced Cathode Ray equipment.

● Controlled linear sweep 0-150,000 C.P.S. ● Controlled external sweep. ● Freq. locking device for sweep frequency. ● Picture centering adjustments. ● Wide range focus adjustments. ● Complete component shielding. ● Unit is self contained and includes batteries and 110V-60 cycle power supply. ● Tubes RCA 906-885-234-281-280.

COMPLETELY EQUIPPED READY TO USE

F.O.B. Newark—\$85.00

1200 V.—500 W. Power Supply \$35.00  
See Mar. QST, p. 70

### TUBES

to fit the depression pocketbook of the amateur fraternity. These tubes are first class products and carry our absolute guarantee for 90 days.

281.....\$.90 866 HD.....\$1.50  
281 Mercury.. 1.35 203A..... 9.35  
210—15W... 1.15 211..... 8.75

### FILTER CONDENSER SPECIAL

Dubilier 903 — 6 mfd-900V.....\$.73  
Dubilier 902 — 6 mfd-700V......45

SANGAMO 002-5000V.....\$.88

FILAMENT TRANSFORMER — 2 windings — 2½V @ 3A — 7½V @ 3 Amp.....\$1.45

PLATE TRANSFORMER — two 7½ and two 2½ volt fil. windings — 750-750-160 mils.....\$3.50

We build transmitters to your specifications.

**KALTMAN & ROMANDER**  
62 Court St. Newark, N. J.

tor. This will give a small amount of capacity coupling. Line up the last i.f. transformer to resonance, as indicated by maximum milliammeter reading. Next hook the wire to the first i.f. tube and line up the second i.f. transformer. Repeat the procedure, coupling to the first-detector grid, to line up the first transformer. After the stages are roughly lined up, the coupling from the test oscillator should be loosened and the i.f. stages re-aligned. In lining up the stages the plate current of the second detector should not be allowed to exceed about 0.5 ma., because the detector starts to overload above this point.

Next proceed to line up the h.f. end. Insert a set of coils, rig up a high frequency oscillator working within their tuning range (the fundamental or a harmonic of the transmitter's crystal stage can be used), and loosely couple the oscillator to the receiver for a trial. (If the oscillator is in the same room sufficient coupling is provided.) First adjust the h.f. oscillator's padding condenser for resonance, remembering that the oscillator is to work at a frequency 465 kc. higher than the signal frequency. Adjust the volume control as needed to keep the meter near mid-scale for tuning. Next line up the first-detector and pre-r.f. by adjusting their padding condensers. After rough adjustments have been made, the coupling to the h.f. oscillator should be loosened and the circuits re-aligned with the crystal switch set to the "Series" position. It will be found hard to tune to exact resonance if there is the least play or back-lash in the dial or the tuning condensers, or if the h.f. oscillator wiring is not sufficiently rigid to eliminate electrical and mechanical changes.

With the set adjusted for resonance with the crystal in, the switch  $SW_2$  should be thrown to the "CW" position. Adjust the audio beat oscillator's padding condenser for the desired audio beat note. The receiver should now be tuned to the "other side of zero beat," and the phasing condenser  $C_3$  adjusted to eliminate this beat (anti-resonance adjustment). When the b.o. is switched on the second-detector's plate current should increase about 0.05 or 0.1 ma. If not, the value of  $C_{24}$  should be changed until it does. When  $C_{24}$  is disconnected there should be no noticeable increase in the plate current of the second detector when the b.o. comes on.

### THE MONITOR

To test the monitor turn  $SW_2$  to "Monitor" position. The plate current of the second-detector should increase about 0.1 ma. The coil specified tunes to the 7-mc. band with almost all the padding condenser in, and to the 14-mc. band with almost all the capacity out. Fire up the transmitter and tune the monitor's padding condenser to resonance. Several signals may be heard as the monitor beats with the transmitter signal, but the tone will not be good on the improper beats. When it is acting as a superhet monitor the audio beat in the 'phones will be as good as the monitored signal will allow. After a few trials it is easy to pick out the correct signal, which appears when the monitor is tuned 465 kc. higher or lower than

# THE Amateur's BOOKSHELF

A balanced selection of good technical books, additional to the A.R.R.L. publications, should be on every amateur's bookshelf. We have arranged, for the convenience of our readers, to handle through the QST Book Department those works which we believe to be most useful. Make your selection from the following, add to it from time to time and acquire the habit of study for improvement. Prices quoted include postage. Please remit with order.

## RADIO THEORY AND ENGINEERING

**COMMUNICATION ENGINEERING**, by *W. L. Everitt*. A general text for both first year and advanced courses. 567 pp., 335 illustrations. . . . . \$5.00

**RADIO ENGINEERING**, by *F. E. Terman*. A comprehensive treatment covering all phases of radio communication. A good all around book for students and engineers. 688 pp., 418 illustrations. . . . . \$5.00

**MANUAL OF RADIO TELEGRAPHY AND TELEPHONY**, by *Commander (now Admiral) S. S. Robinson, U.S.N.*. Published by the Naval Institute. Covers both the theoretical and practical fields. 791 pp., 6¼ x 9. . . . . \$4.00

**ELEMENTS OF RADIO COMMUNICATION**, by *Prof. J. H. Morecroft*. This is the 2nd edition of this book by the author of the "Principles" listed elsewhere. It is about half the size of the larger work, and the subject is treated in more elementary fashion. Simple algebra is sufficient. An excellent book for the "first-year" student. 279 pp., 170 illustrations. . . . . \$3.00

**PRINCIPLES OF RADIO COMMUNICATION**, by *Prof. J. H. Morecroft*. An elaborate general textbook, and one of the recognized standards on theory for the engineering student. A working knowledge of mathematics is desirable for the reader who expects to get the greatest benefit from this work. 1001 pp., 5¼ x 9. . . . . \$7.50

**PRINCIPLES OF RADIO**, by *Keith Henney*. This book is chock-full of meat for the experimenter. The subjects treated range from the fundamentals of electricity to the modern concepts of modulation and detection. 477 pp., 306 illustrations. . . . . \$3.50

**THEORY OF THERMIONIC VACUUM TUBES**, by *E. L. Chaffee*. Based on Dr. Chaffee's research and study at Harvard University, this book offers much new material and many new presentations, especially in connection with regeneration. Recommended particularly for advanced study. 652 pp., 360 illustrations. . . . . \$6.00

## RADIO EXPERIMENTS AND MEASUREMENTS

**RADIO FREQUENCY ELECTRICAL MEASUREMENTS**, by *H. A. Brown*. A thoroughly practical book for the experienced amateur, the experimenter or engineer who has knowledge of the elementary principles of radio communication and of alternating currents. . . . . \$4.00

**HIGH-FREQUENCY MEASUREMENTS**, by *August Hund*. A thorough, modern book, especially useful in advanced laboratory work. Includes a chapter on piezo-electric determinations. 491 pp., 373 illustrations. . . . . \$5.00

**EXPERIMENTAL RADIO ENGINEERING**, by *Prof. J. H. Morecroft*. An excellent laboratory text directed specifically to

emphasizing the principles involved in the operation of radio apparatus and intended as a companion to the same author's "Principles." Following an introductory chapter on instruments and accessories, 51 choice experiments are outlined. 345 pp., 250 illustrations. . . . . \$3.50

**EXPERIMENTAL RADIO**, by *Prof. R. R. Ramsey*. Revised Edition. A splendid book for the experimenter. This is a laboratory manual, describing 128 excellent experiments designed to bring out the principles of radio theory, instruments and measurements. 150 illustrations, 229 pp., 5¼ x 7. . . . . \$2.75

## COMMERCIAL EQUIPMENT AND OPERATING

**RADIO THEORY AND OPERATING**, by *Mary Texanna Loomis*. Although giving a moderate amount of theory, it is essentially a practical handbook for commercial and broadcast operators, and as such ranks among the foremost publications of this sort. Used as a textbook by many radio schools. A good book for any amateur. 1000 pp., 800 illustrations. . . . . \$4.25

**THE RADIO MANUAL**, by *George E. Sterling*. Another excellent practical handbook, especially valuable to the commercial and broadcast operator, and covering the principles, methods and apparatus of all phases of radio activity. Over 900 pp. . . . . \$6.00

**RADIO TELEGRAPHY AND TELEPHONY**, by *Duncan and Drew*. Still another work along the lines of a general practical handbook. In size it is approximately the same as the two listed just previously, and the subject matter generally follows along the same lines. A good book in this class. 950 pp., 468 illustrations. . . . . \$7.50

**HOW TO PASS U. S. GOVERNMENT RADIO LICENSE EXAMINATIONS**, by *Duncan and Drew*. Intended as a companion volume to "Radio Telegraphy and Telephony" by the same authors, as a guide to the applicant for commercial

licenses. It is not a text in itself. The chapter arrangement follows that of the sections of the commercial theoretical examination, each being made up of typical examination questions and their answers. 169 pp., 92 illustrations. . . . . \$2.00

**RADIO TRAFFIC MANUAL AND OPERATING REGULATIONS**, by *Duncan and Drew*. A book for students, amateurs or radio operators who contemplate entering the commercial field; it will enable you to learn quickly and easily all the government and commercial traffic rules and operating regulations. 181 pp. . . . . \$2.00

**PRACTICAL RADIO TELEGRAPHY**, by *Nilson and Hornung*. Written particularly for the student training for a commercial license, and covering theory and apparatus. A practical handbook. 380 pp., 223 illustrations. . . . . \$3.00

**RADIO OPERATING QUESTIONS AND ANSWERS**, by *Nilson and Hornung*. A companion volume to "Practical Radio Telegraphy" by the same authors. The 1934 Revised Edition is very complete, covering Commercial and Broadcast, Amateur, Aeronautical and Police Radio, Beacons, Airways, Meteorology, and Teletype Operating. 350 pp., 5¼ x 8. . . . . \$2.50

## MISCELLANEOUS

**THE RADIO AMATEUR CALL BOOK**. Lists all U. S. and foreign amateur radio stations, s.w. commercials and broadcasters. . . . . \$1.10

**BELOW TEN METERS**, by *James Millen and R. S. Kruse*. Ultra-high-frequency oscillators, radiating systems, receivers, theories, measurements, television reception, etc. Abundant photographs and diagrams. 64 pp. . . . . \$1.50

**ELECTRICITY, WHAT IT IS AND HOW IT ACTS**, by *A. W. Kramer*. A modern treatment with the electron as its basis. It deals only with accepted theories, presenting them

simply and straightforwardly so that those not mathematically minded can understand them. Two volumes, 592 pp., 24 illustrations. . . . . \$4.00

**RADIO DATA CHARTS**, by *R. T. Beatty*. A series of graphic charts for solving, without the use of mathematics, most of the problems involved in receiver design. 82 pp., 8¼ x 11. . . . . \$1.50

**SERVICING RECEIVERS BY MEANS OF RESISTANCE MEASUREMENTS**, by *J. F. Rider*. 203 pp., 94 illustrations. An excellent book for the service man and amateur constructor. . . . . \$1.00

AMERICAN RADIO RELAY LEAGUE, INC.  
WEST HARTFORD, CONNECTICUT

# Here to Stay

Announced but a few months ago, the D-104 Piezo-Astatic Crystal Microphone has proven its merits and substantiated all claims made for it. Meeting the essential requirements in Radio and Public Address fields and surpassing in performance and durability microphones costing many times its price, the D-104 is here to stay.

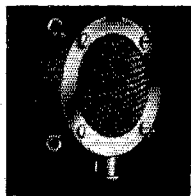

## PIEZO-ASTATIC

Crystal Microphone

Type D-104

### EXCELLENT FREQUENCY RESPONSE

No adjustments. No carbon rush. No packing. No blasting. No freezing. No button or field current. No polarizing voltage.

Connects direct to grid, or may be used with matching transformer. **\$21.00**  
List price.....

*Licensed under Brush Development Co. patents*

Astatic Microphone Laboratory, Inc.  
Youngstown, Ohio

## AMATEURS ATTENTION!

Thordarson interstage 56 P.P. to 2A 3 P.P. ....	\$2.19
Thordarson output 46's class "B" to 500 ohms. ....	2.94
Thordarson Swinging Filter Choke, class B. ....	2.93
Thordarson Input, 46 to 46's in class B. ....	2.94
Thordarson velocity micr. trans., single grid, 100M ohms. ....	1.75
Franklin class B output, P.P. 46's to 5000 ohms. ....	2.25
Franklin class B input, 46 to P.P. 46's. ....	2.25
Mershon 18 mfd. wet electrolytic cond. ....	.55
Bud S.W. Coils, 16 to 200 meters, 4 prong, No. 4 coils	1.75
8 mfd. dry elec. cond. cardboard, 500 V. d.c. ....	.49
8 mfd. dry elec. cond. alum. can, 500 V. d.c. ....	.55
NATIONAL FB-7A S.W. receiver. ....	34.20
NATIONAL FB-XA S.W. receiver with Xtal. ....	47.70
NATIONAL SW-3 S.W. receiver. ....	17.70
HAMMARLUND Comet "PRO" S.W. receiver, with tubes and coils. ....	95.37
Hammarlund "Star" midjet variable cond.—50 mmf. 55c; 100 mmf. 60c; 140 mmf. 75c; 35 mmf. double spaced 60c.	
REALTONE tubes (Triad made) all types, 6 months guaranteed, 50% & 10% off list.	
Continental model No. 10 micro., chrom. plated, 2 button. ....	4.20
Continental model No. 25 micro., 2 button, list \$25. ....	10.00
Continental model No. 50 mike, 2 button, list \$50. ....	25.00
Bright Star No. 4 dry cell, 1 1/4 V., 1 1/4" x 4" — for monitors, etc. ....	15
Bright Star B batteries, 45 V. standard \$1.00; H. Duty \$1.35	
RCA-De Forest, Raytheon and Sylvania Xmitting tubes stocked.	
RCA-De Forest type 800 xmitting tube. ....	10.00
RCA-De Forest cathode-ray tubes: No. 905. ....	18.00
National Cathode Ray Oscillograph kits in stock:	
Ratheon RK-18. ....	\$10.95; RK-19. .... \$ 7.50
Sylvania No. 830. ....	\$ 8.75; No. 860. .... \$35.00
Lynch short wave antenna systems. .... kit	3.52
National transposition blocks—victrol. ....	.21
National 5 meter coils. ....	.27

*Write for prices*

20% deposit with all C.O.D. orders.  
Include postage. Remit by M. O.

**Maurice Schwartz & Son**

710-712 Broadway, Schenectady, N. Y.

the signal. Make any necessary adjustments for signal level as previously described.

In normal operation the receiver is calibrated and used to check frequency "direct." This works out very well if some setting on the dial is checked after the receiver is warmed up. Normally the transmitter's crystal oscillator of a station whose setting on the dial has been previously noted, is used for a check.

The operation of the receiver has been very satisfactory, and the author feels amply repaid for the work expended on its design and construction. Needless to say, there has been an increase in the number of DX stations worked at W9IJ since this S.S. receiver has been in use.

## Regeneration in the R.F. Stage

*(Continued from page 55)*

Zepp antenna, the condenser  $C_{10}$  being used for tuning when the Zepp antenna is employed. A 65-foot antenna with 32-foot feeders has been used with considerable success, the "dead" feeder being connected to the metal chassis of the set. The condenser  $C_{10}$  is extremely useful in adjusting the antenna circuit so that maximum signal strength can be secured without loading the r.f. stage so much that it cannot be made to reach the oscillating point.

The multiple switch,  $SW$ , opens the negative "B" and positive "C" leads as well as one filament-battery lead, thus disconnecting the "B" and "C" batteries from their potentiometers when the filaments are off and thereby increasing the battery life. A filament rheostat and filament voltmeter insure operation of the filaments at rated voltage at all times. The total "B" current, including that taken by the potentiometers, is only 12.5 milliamperes.

The tuning of the receiver is similar to that already described for the a.c. set. By careful adjustment of the r.f. stage the gain can be very greatly increased over that normally expected. Although the receiver is used chiefly for c.w. work, 'phone signals come through nicely—and the additional selectivity provided by the regenerative r.f. is a great help in separating them. In all, the system is an economical and relatively simple method of bettering the performance of the t.r.f. receiver.

## Completing the Three-Stage Transmitter

*(Continued from page 51)*

band will be known. Providing the precautions previously mentioned with respect to the inductances of the coils have been observed, it should not be necessary to re-neutralize either the buffer or final amplifier stage when shifting bands. Should experiment show that this is not the case, however, the neutralizing condensers could be provided with scales marked so that the proper setting for each band is plainly evident.

Representative plate-current readings for three bands are: 3.5 mc., oscillator, 25 ma., doubler 30 ma.; 7 mc., oscillator 30 ma.; doubler 45 ma.; 14 mc., oscillator, 30 ma., doubler, 60 ma.



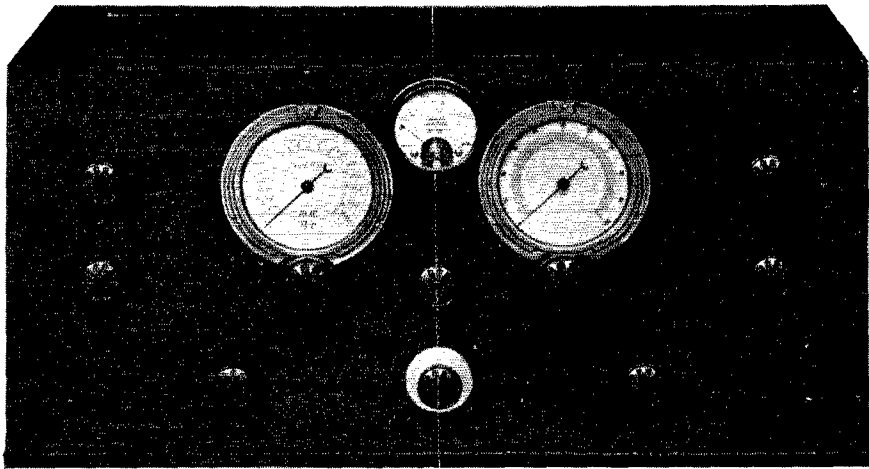

## RME-9 SINGLE-SIGNAL SUPER

540 KC to 22000 KC

An entirely new conception in band spread tuning and accurate logging of stations on all frequencies found in this receiver. Every up-to-date feature desired is included in the design. Priced very moderately.

For the advanced amateur and professional operator this receiver presents the solution to congested traffic problems. It will meet the requirements desired. Send 10 cents in stamps for a complete descriptive folder.

**RADIO MFG. ENGINEERS, 147 COOPER AVE. PEORIA ILLINOIS**

**LEARN RADIO** New Classes Now Forming! Send for 40-page catalog, explains fully, 180 licensed graduates placed in past 2½ years in broadcasting, shipping, police radio, aviation, etc. We teach all branches. Oldest, largest and best equipped school in New England. Equipped with Western Electric sound and broadcasting equipment and RCA marine transmitter. Course prepares for United States Government telegraph or telephone license.

MASS. RADIO SCHOOL, 18 Boylston Street, BOSTON

## HOW TO LEARN CODE

*YOU* can learn Code — or step up your w.p.m. amazingly — this surer way. No experience needed. Beginners, amateurs, experienced ops get ahead faster with Teleplex. It doesn't merely "show" you Code — it IS Code! You actually *HEAR* dots-dashes any speed you want. Sends you practice messages and *SENDS BACK* your own key work, which no other system can do.

For quicker license find out about this better way, used by U. S. Army, Navy, R.C.A., A.T. & T. and many others. We give you complete course, lend all equipment, give personal service on **MONEY-BACK GUARANTEE**. Low cost, easy terms. Without obligation write for booklet Q. 17.

**TELEPLEX COMPANY**

76 Cortlandt St.

New York, N. Y.



## TUBES FOR THE AMATEUR

Raytheon tube design keeps step with QST circuit developments. The amateur who holds his transmitter to the highest A.R.R.L. standards will find Raytheon tubes the best choice.

Write for Technical Data on Raytheon RK-18, RK-15, RK-16, RK-17, RK-19, R-866A.

**RAYTHEON PRODUCTION CORPORATION**

30 E. 42nd Street, New York, N. Y.

or

San Francisco — Chicago — Newton, Mass.

# TWENTY YEARS

— brings maturity to a man, a magazine or a manufacturing organization — GENERAL RADIO celebrates its twentieth anniversary in 1935.

## TRANSFORMERS

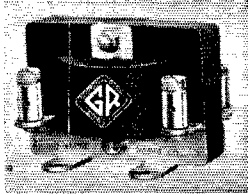

In 1915 the Company developed the first commercially available closed-core audio transformer. The Type 231-A was popular for years in the early days of broadcasting.

The result of years of experience in audio-frequency design is incorporated in the Type 541 and Type 585 Transformer lines. The wide frequency range (30–10,000 cycles) meets the requirements of modern communication systems. Types are available for all circuit requirements.

In the transmitter or receiver circuit they insure transmission meeting modern standards.

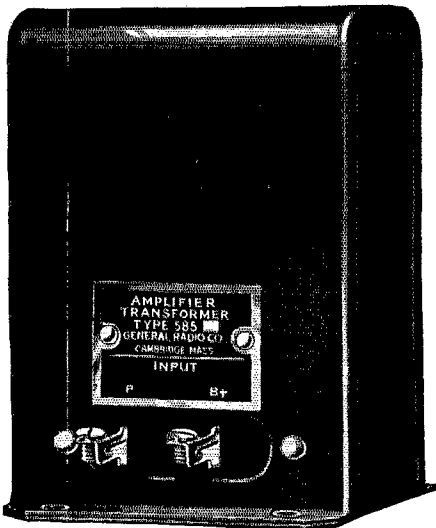

Type	Use	Price
541-C	P.P. Plate to Speaker	\$6.00
541-P	P.P. Plate to Line	12.00
541-J	P.P. Input	7.50
541-G	Line to Grid	12.00
585-M	Microphone to Grid	10.00

**GENERAL RADIO  
COMPANY  
CAMBRIDGE, MASSACHUSETTS**

The amplifier plate current will depend upon the loading, of course. It should be kept in the vicinity of 110 milliamperes on all bands, although it is easily possible to get more power output by increasing the plate current.

If the plate voltage available for the buffer stage is not more than 400 volts, somewhat greater output can be secured from this stage by substituting a 46 for the 841. As pointed out in the preceding article, however, the 841 is free from grid emission troubles and is therefore to be preferred if higher voltage is used. Even at 400 volts the 46 is likely to show the familiar but unwelcome sign of grid emission—climbing plate current—when doubling to 14 mc., unless a particularly “hard” tube is used.

A 60-watt lamp connected across the output terminals of the antenna coupler makes a good dummy antenna for use during the preliminary adjustments to the transmitter. Such a lamp carries only a slightly higher rating than the normal output of the 830 amplifier, and it should be possible to light it nearly to full brilliancy when the transmitter is working properly.

The final amplifier can be used to double to 28 mc. by plugging in a coil having approximately four turns of  $\frac{1}{8}$ -inch copper tubing wound to a diameter of  $2\frac{1}{2}$  inches. It will not be necessary to change the setting of the neutralizing condenser when working on this band. The power output probably will be low compared with the output obtainable on the other bands, but should be sufficient for occasional experimental work.

## Suppressor-Grid Modulation

(Continued from page 39)

duce the amplifier plate current 50% may look tempting; but the lower bias will result in a reduction of sideband power and will seriously affect the quality. The smallest size B batteries are satisfactory for biasing the suppressor grid, since there is practically no suppressor current. An inexpensive single-button microphone operating from a 6-volt battery will be satisfactory with this modulator, although a less sensitive double-button microphone will probably require an additional stage of speech amplification.

### HOW IT GETS OUT

Operated with the comparatively low plate voltage specified and using an inexpensive single-button microphone, surprisingly good results have been obtained with this transmitter. Reports of quality of a grade usually associated with more expensive microphones are attributable to the small distortion introduced in the single-stage audio circuit and the fool-proof nature of the suppressor-grid system of modulation. Signal strength comparable to that of considerably higher-powered outfits has been especially noticeable, emphasizing the merit of a stable transmitter free of frequency modulation and overmodulation. There's no beating the outfit that puts all its wallop into the minimum frequency channel a 'phone should occupy.

**1919**

# — FIFTEEN YEARS —

**WE ARE CELEBRATING OUR 15TH ANNIVERSARY**

**1934**

Back in the spark days, we started business and in all the years we have been supplying Amateur equipment, we have enjoyed the friendship and the problems of the "Ham" fraternity. It makes us happy and proud to say that our business has grown so great, because we have had the patronage and recommendation of so large a number of "Ham" friends. We are always enthused over the development and construction of new equipment and get a big kick out of being able to co-operate, by having a good stock and making prompt shipments. Our store has come to be known as the Tri-State headquarters, as the "Ham Gang" from Pennsylvania, Ohio and West Virginia all meet here for a "Rag chew." The Cameradio Club "Rig" W8FIR is in the building and we will do our best to make you feel at home. We invite you to arrange to meet your friends here, when you visit Pittsburgh.

**COME  
ONE**

**ATLANTIC DIVISION CONVENTION  
PITTSBURGH, PA.  
JUNE 22nd & 23rd, 1934**

**COME  
ALL**

We anticipate the pleasure of meeting our many friends, when they attend the Convention next month, and hope they will be sure to visit our store where we will have on display a complete line of the latest developments in radio, including:—

**HAMMARLUND CRYSTAL "PRO"      NATIONAL CRYSTAL "FBXA"**  
Our 1934 catalog mailed on request — It is free

NATIONALLY  
ADVERTISED  
RADIO  
PRODUCTS

# CAMERADIO

**603 GRANT ST.  
PITTSBURGH ~ ~ PA.**

EVERYTHING  
FOR THE  
RADIO  
AMATEUR

### — HAIL, QST — SHAKE, OLD TIMERS —

We've Been with You 19 of Those 20 Years

8ML has helped to make QST history—in Transatlantics (million watts, QST March '23, page 58), in QST articles May, Dec. '23, June '21. 8ML's fan made Ballantine. And in our 133 advertisements in QST pioneering the Edison B battery, the Mercury Arc Rectifier, individually designed amateur and commercial power equipment, and relay racks and panels to give your station that prized NBC Air. See also our Sept. '33, Jan. '34 display advs. Distributor of A. C. Ross Co. products.  
Rectifier Engineering Service, 4837 Rockwood Rd., Cleveland, Ohio

## GULF RADIO SCHOOL

Radiotelegraphy      Radiotelephony  
Radio Servicing

SECOND PORT } 1007 Carondelet Street.  
U. S. A. } NEW ORLEANS, LA.

## For the good of the amateur game

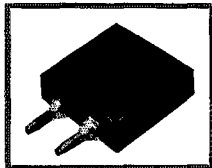

Crystal Holder, \$1.50

be sure of your transmitter frequency . . .  
use

### PRECISION CRYSTALS

For the one tube crystal transmitter or the multi-stage outfit — you can get nothing better than a **PRECISION CRYSTAL**. They keep your transmitter on frequency and give more power output. Play safe with **PRECISION CRYSTALS**.

**PRECISION CRYSTALS** are X cut, one inch square from the best grade of Brazilian quartz, scientifically ground for maximum power output and thoroughly tested.

When ordering a **PRECISION CRYSTAL** you are assured of the finest obtainable.

Temperature controlled ovens and crystals for commercial use quoted on at your request.

Not a dissatisfied customer in 5 years.

Prices of crystals ground to within 0.1% of your specified frequency in the amateur bands. Calibration accuracy .03%.

1750 & 3500 kc. bands . . . . .	\$3.90 ea.
7000 kc. band . . . . .	\$4.25
Following with holder illustrated.	
1750 & 3500 kc. bands . . . . .	\$4.90 ea.
7000 kc. band . . . . .	\$5.25
Jacks to plug holder into . . . . .	\$ .15 pair

## PRECISION PIEZO SERVICE

427 Asia Street

Baton Rouge, La.

(Continued from page 32)

reach. Its first official photo appeared in the first post-war number of *QST*, July, 1919—and, says that issue, when the Wouff-Hong was displayed at the Director's meeting, "each face noticeably blanched."

\* \* \*

The second instrument of torture, the Retty-snitch, which stands for decency in operating and shares the editorial chamber with its mate, the Wouff-Hong, was presented to Traffic Manager Fred Schnell by the Washington (D. C.) Radio Club at the 3d District Convention in 1921. It was already minus two of its teeth, giving evidence of earlier use.

The name of the sacred Wouff-Hong has been otherwise perpetuated by the Modesto (Calif.) Radio Club, whose annual trophy is a replica of the original Wouff-Hong, moulded from the melted-down elements of tubes from five hundred record-breaking transmitters; and by the Royal Order of the Wouff-Hong, a mystic society conceived by a ham group in Flint, Michigan, some years ago.

All good hams, and otherwise, stand in dread of the Wouff-Hong and Retty-snitch and The Old Man. The three have become traditions in amateur radio. There have been many reports of coming upon The Old Man, but somehow or other they always blow up—but that is another story.

### DX Contest

(Continued from page 58)

station should not compete on the same basis. Others say that the working man has a tremendous handicap, too great to allow him to win. Should the station with a single-signal receiver be further handicapped? We think the present contest "free for and open to all" with no handicapping is a sound solution. High power most certainly isn't the answer. We cite the case of another station that entered the contest of last year as well as this year. The antenna and location were identical both years. A staff of 3 operators kept the station on the air 15 hours a day with an input of 1 kw. last year. This station in the present contest, with one operator, operated an average of 9 hours a day; three before breakfast, one at noon, three at night—with the weekends bringing up the average. The power in the present contest was limited to 500 watts for seven of the nine days, and final results showed that last year's combined 3-operator score had been more than tripled! Perhaps the use of ten different frequencies in the 7- and 14-mc. bands plus a single-signal receiver accounted for the difference in score—certainly the power which had been halved had nothing to do with it.

Just as we go to press we receive word from W3ZJ, Tom Hall, Harrisburg, Pa., advising that his score totalled slightly over thirty-three thousand points! That, gentlemen, is just 120% higher

# DON'T WORRY ABOUT THAT EXAM!

## Candler Specialized Training Will Make It Easy For You

AMATEUR RADIO, THE A.R.R.L. and THE CANDLER SYSTEM Have Grown Up Together

They have demonstrated the fact that only very good and original ideas, continuously improved upon, can last twenty years and longer. The Candler System congratulates the A.R.R.L. on its twentieth anniversary and wishes it many more useful years in serving ham radio.

We have, during these years, prepared a vast army of fellows for their Amateur and Commercial Exams. This great army of experts is located in all countries of the world.

### WHAT CHAMPIONS and OTHERS SAY

"As champion Radio op for 13 years, official speed 56½ wpm., and holder of all-time American Morse speed record of 70 wpm., I can say that I never had any other training except CANDLER SYSTEM HIGH-SPEED TELEGRAPHING and 'MILL' COURSES."—T. R. McElroy, 23 Bayside St., Boston, Mass.

"CANDLER SCIENTIFIC CODE and 'MILL' COURSES made it possible for me to win the Radio championship in Class 'E.'"—Jean Hudson, W3BAK.

"CANDLER Specialized Training enabled me to pass rigid, competitive test for this position."—Richard D. Watson, Op., WHEW, Byrd Expedition.

"I owe my position as code instructor, Air Corps, Primary Flying School to CANDLER Specialized Training. I instruct over 200 student flyers in code every 4 months which requires absolute accuracy."—Carl W. Muller, 46th Squadron, Randolph Field, Texas.

"Am working trans-Pacific circuit between Honolulu and Frisco. Am combination op—American Morse and Continental. Hold a 1st class license. I could not have done this without the aid of Candler Specialized Training."—James Light, U. S. N. Radio Station WAILUPE, Honolulu, T. H.

If you want to learn code RIGHT, or if you want to increase your speed in order to take the exam., or hold a better job, tell us your problems and we'll give you our experienced advice. We have helped thousands to achieve success. We can help you.

### Three Celebrated CANDLER SYSTEM COURSES

SCIENTIFIC CODE COURSE for beginners. Teaches all the necessary code fundamentals scientifically.

HIGH-SPEED TELEGRAPHING for fellows with speeds from 12 to 35 wpm. who want championship speed and technique.

TELEGRAPH TOUCH-TYPEWRITING for those who want to become expert in the use of their "mill" in receiving fast stuff by "touch." Nothing else like it.

### Send for new BOOK of FACTS Today

It tells the whole interesting story of what others are accomplishing as a result of this unique and exclusive training. You don't need to worry about your code speed or about passing the exam. This FREE BOOK will be a pleasant revelation to you.



CANDLER SYSTEM CO.  
Dept. Q-5 6343 S. Kedzie Avenue, Chicago



## Lots of Activity on 5 Meters

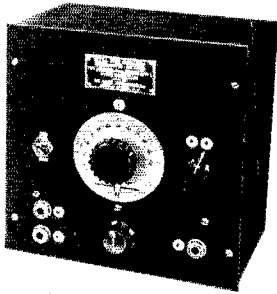

The New Haigis Transmitter-Receiver **\$17.40**

Less Tubes and Batteries

A Combination Receiver Transmitter for operation on 5-meter Band. Transmit or Receive by throwing one switch — Voice or Tone Modulation at will. Side tone for monitoring. Developed by pioneers in field who have satisfied requirements of Army and Navy. Uses one 30 and one 33 tube.

Tubes \$2 Extra  
Batteries \$5.64

The New National Code Practice **OSCILLATOR** **\$3.60**  
Less Tube and Batteries

Excellent for modulating 5-meter Transmitters for ICW transmissions. Uses one 30 tube and four flashlight cells.

### Cornell — Dubilier Pyronol Dielectric Transmitting CONDENSERS

Pyronol Dielectric permits extreme compactness and high efficiency:

1 Mfd	1000 Volt	.....	\$2.65
2 Mfd	1000 Volt	.....	4.00
1 Mfd	1500 Volt	.....	3.65
2 Mfd	1500 Volt	.....	5.75
1 Mfd	2000 Volt	.....	6.75
2 Mfd	2000 Volt	.....	7.90

Special this month Thordarson Power TRANSFORMERS **\$3.65**

Secondary No. 1,	1000 Volts, C. T.,	125 mils.
Secondary No. 2,	7½ Volts, C. T.,	2.5 Amps
Secondary No. 3,	5 Volts, C. T.,	2½ Amps
Secondary No. 4,	2½ Volts, C. T.,	8½ Amps

**M & H SPORTING GOODS CO.**  
512 MARKET STREET  
PHILADELPHIA

## The New National Cathode Ray Oscilloscope

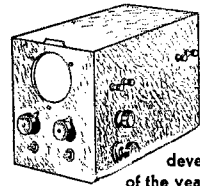

Less Tubes **\$17.70**

One of the outstanding developments of the year.

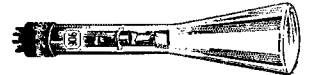

R.C.A. Type 906 Tube (3" screen) **\$18**

The National Oscilloscope offers a means of checking both phone and c. w. transmitters. Makes it possible to get the utmost out of them. Simple, compact, low in cost. Will do everything the more complicated Oscilloscope will do.

## BUILT EXCLUSIVELY FOR THE AMATEUR

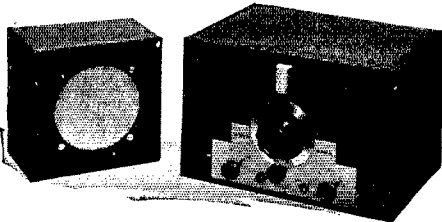

Specifically Designed for the Finest Reception over Four Amateur Bands

The new ROSS JUPITER is a specialized receiver for the fellow who is looking for a real thrill from the finest in amateur radio reception — not an all wave receiver with a few concessions to the amateur. Amazingly selective on all four popular amateur bands. Brings in what you want when you want it and in a full, well-rounded tone. No coils to buy or change. You shift from one frequency to another by turning a panel switch. Coils are an integral part of set. Complete with powerful Wright De Coster dynamic speaker in cabinet, but less tubes, only \$69.50, net.

**A. H. ROSS AND COMPANY**  
Keswick Ave. and Waverly Rd., Glenside, Pa.  
(Suburb of Philadelphia)

WRITE FOR FOLDER

## To ARRL — CONGRATS.

TO THE RADIO AMATEUR:

ARRL's 20 years, devoted to keeping you abreast of the times with regard to modern equipment, has been largely responsible for your prided signal. YOU CAN ADD STILL FURTHER QUALITY AND EFFICIENCY BY USING THE MODERN, AUTOMATIC TRANSMITTING KEY —

## "GO-DEVIL"

THE ONLY KEY OBTAINABLE WITH THE FOLLOWING MODERN FEATURES

Tungsten contacts at no extra cost. Ratio between the levers changeable for doubling the intensity of the dots. Change of adjustments does not throw the contacts out of alignment. Heavy non-skid base.

A BEAUTIFUL INSTRUMENT

ABSOLUTELY GUARANTEED TO BE MORE THAN SATISFACTORY

A key the beginner can successfully operate and an instrument the old timer will be proud to own.

Shipped by return mail from

**A. H. EMERY**  
263 MILL ST.  
Poughkeepsie, N. Y.

\$6

Includes U. S. Postage

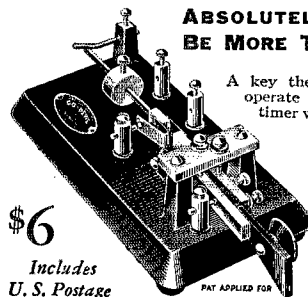

PAT APPLIED FOR

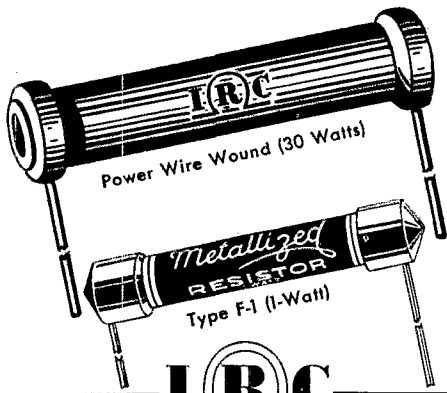

## INSIST ON IRC'S FOR EVERY RESISTOR NEED

For practically every resistance need, whether in radio service or amateur work, there's an IRC Resistor that will do the job to perfection — one that is backed with a record of successful performance which means far more than anything we might say in its behalf. Standardize on IRC's for every requirement. They cost no more than ordinary units — and they excel by actual test.

### INTERNATIONAL RESISTANCE CO.

2100 Arch St., Philadelphia, Pa.  
(In Canada, 74 Wellington St. W., Toronto, Ont.)

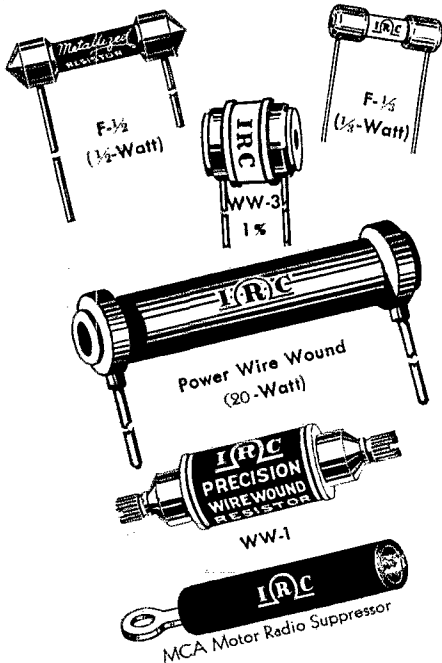

WRITE FOR **IRC** CATALOG A-40

than last year's highest American score! With this bumper score W3ZJ has set an all-time record for a DX-Contest score! It will take some real planning and work next year to beat this record.

Musings prompted by the DX Contest, which may be appreciated in many cases, were contributed by W6ANN and others. . . . The smile of satisfaction from the man who came to read the light meter. . . . The BCL who banged on the floor every so often. . . . Forgetting to turn the clock to alarm after carefully setting it. . . . That noise in the receiver that took a good swat to stop. . . . Wishing I had a crystal on the edge of the band. . . . And a kilowatt behind it. . . . How the foreigners would be nicely out in the open and while shooting the breeze, but the minute the number started!?!!(?. . . . Hearing those rare intermediates and the other local station working them. . . . That feeling of looking out of two holes in a sheet after the third day. . . . That continual yell from the next room to come to bed. . . . After the fourth day wondering if the darned thing would ever quit, wanting to quit and afraid to because everybody else would beat you too badly. . . . How many stations rebuilt their transmitters before the contest was over. . . . How many worried over the serial numbers starting with a zero when it was time to check up. . . . J2IN being heard for two hours one afternoon, had one contact, rest of the time he was CQing and VE3WA was answering (not working). . . . W2BSR shined up all equipment deleting all haywire for the contest, parasites appeared that wouldn't go so the old haywire was reinstated with excellent results. . . . W9NPW rebuilt for the contest, had one contact, was taken sick for the duration of the contest. . . . Leaving the shack during a dull period W6QD became involved in an auto accident, resulting in a broken collarbone, says it was the left "wing" and didn't cause too much discomfort after the first couple days. . . . W7VY begrudges time needed to sleep; was on constantly with the exception of 31 hours of sleep during the entire nine days. . . .

After years of DX contests and pages of rules we still see W contacting W and exchanging numbers for more credit; and foreign amateurs working other foreigners and exchanging numbers. . . . No, VK7 is not a separate country—Scotland still stays with England as a single multiplier, as do ZU, ZT, and ZS for South Africa. . . . Practically every report contains a note of explanation of a number which was sent in error.

Many American stations (especially on the East Coast) had their first taste of Japanese DX. Our hats off to J2GX and J2IN for being so active and affording so many of us another crack at a WAC! No less than two-dozen stations have mentioned that one or another of these stations turned the trick. VU and VS stations occasionally were reported on the East Coast, but a contact with Asia other than via J was rare from this section.

Many countries were heard on the air with a single representative. In these cases those stations were in great demand. Those prominent in this

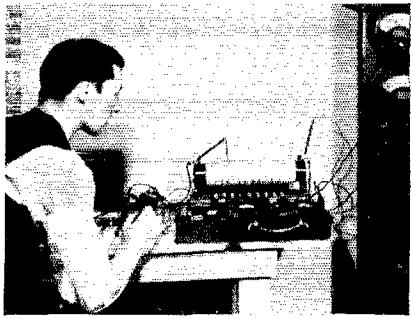

● **Student Taking an A.C. Measurement**

Learn Theory and practice on modern transmitting and receiving equipment in our own laboratories with trained instructors, right here in Washington — the center of Radio activity.

**CHOICE OF THREE COURSES OF STUDY—**

The RESIDENCE COURSE as explained above — the HOME STUDY COURSE, more thorough and advanced than the usual "correspondence" course — and the COMBINATION COURSE of both!

**FREE CATALOG—**

Complete new illustrated booklet with full information regarding Residence and Home Study Courses. Write today. No obligation whatsoever.

*Endorsed by Leading Engineers as*  
**The Most Thorough**  
**ONE YEAR COURSE**  
 in **ADVANCED.....PRACTICAL**  
**RADIO ENGINEERING**

If you'd rather "punch" time, than mark time . . . if you want to get somewhere in Radio, NOW, while opportunities beckon everywhere . . . investigate the CREI courses in Radio Engineering. We offer more in our *one year* Residence Course than any other four year college course in the United States. This is the ideal, recommended course for the man who is serious about advancing quickly in Radio.



**14th and PARK ROAD, N. W. DEPT. QS-5**  
**WASHINGTON, D. C.**



*New!*  
**UNIVERSAL**  
 Stretched Diaphragm Type  
**1934 MODEL "X"**

Here is microphone value without precedent! A brand new 1934 model, *stretched diaphragm* type. Full Diaphragm Protection 2-button microphone, listing at only \$10.00! Exceeds every reasonable requirement for quality performance.

**UNIVERSAL MICROPHONE CO., Ltd.**  
 424 Warren Lane Inglewood, Calif., U. S. A.

**ALUMINUM BOX SHIELDS** Genuine "ALCOA" stock  
**SPECIAL \$1.15**  
 6" x 5 1/2" x 6"

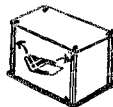

**Something New!** **W 2 GT.**  
 Your call letters, or any marking for your panel, on BLACK aluminum ribbon. Looks like engraving on bakelite. 5c up to 2 inches. 5c each additional inch. Sample 8c.



**PAWOOD CIRCLE CUTTER**  
 Simplifies cutting of Meter and Socket Holes, etc. Heavy duty tool equipped with tool steel cutter, for use in hand brace or drill. Cuts aluminum, and other metals, hard rubber, bakelite, etc. Adjustable 1" to 5 1/2" diameter. **PAYS FOR ITSELF ON FIRST JOB** in time and labor saved. Does a perfect job in a few minutes.

Price \$2.50  
 Specify Round or Square Shank  
 New Master Teleplex on demonstration.  
**BLAN, the Radio Man, Inc.** 177P Greenwich Street New York City

*New*  
**BIRNBACH AIDS for Amateurs**



**ALL-WAVE ANTENNA KIT.** Greatly improves signal strength and clarity. Reduces noise. Ideal for both short and broadcast waves. Includes doublet antenna, transmission line, coupler and all accessories. List price, \$3.75, complete.

**STANDOFF FEED-THRU INSULATORS.** Most complete line. Ten models, 1/2" to 1 1/2" high, 6 1/2c to 30c each. Finest glazed porcelain. Nickel-plated hardware. One-hole mounting, with insulated collar for metal panels. Jack or nut-and-screw types.

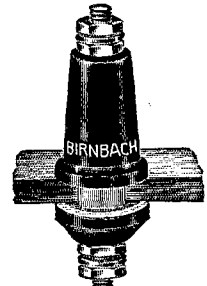

**ANTENNA TRANSMISSION BLOCKS.** New design with rounded edges and fewer bends to injure wire. Prevents twisting of leads. Highest grade, high-resistance ceramic of great strength. List price, 15c each.

Write for Complete Data "Q-5"

**BIRNBACH RADIO CO., INC.**  
 145 Hudson Street New York City

# A.R.R.L. EMBLEM

— insignia of the radio amateur



**I**n the January, 1920, issue of *QST* there appeared an editorial requesting suggestions for the design of an A.R.R.L. emblem — a device whereby every amateur could know his brother amateur when they met, an insignia he could wear proudly wherever he went. There was need for such a device. The post-war boom of amateur radio brought thousands of new amateurs on the air, many of whom were neighbors but did not know each other. In the July, 1920, issue the design was announced — the familiar diamond that greets you at the top of this page — adopted by the Board of Directors at its annual meeting. It met with universal acceptance and use. For fourteen years it has been the unchallenged emblem of amateur radio, found wherever amateurs gathered, a symbol of the traditional greatness of that thing which we call Amateur Spirit — treasured, revered, idealized.

## DO YOU WEAR THE A.R.R.L. EMBLEM?

THE LEAGUE EMBLEM, IN HEAVY ROLLED GOLD AND BLACK ENAMEL, IS AVAILABLE IN EITHER PIN OR BUTTON TYPE.

There are three special colors for Communications Department appointees. . . .

- ▶ Red background for the SCM
- ▶ Blue background for the ORS
- ▶ Green background for the RM

Red and green available in pin type only; blue may be had in either pin or button style. All Emblems priced the same. . . . \$1.00, postpaid.

**American Radio Relay League**  
West Hartford, Connecticut

manner were: HP1A, YV7BC, YB5AA, EZ4SAX, K4AAN, LY1J, HI8X, ON4CSL, UN1DB, FF8SUD, F3MTA, VP6MR and VP9R.

ZLIFT was active and doing business with four 201-As and an input of 18 watts! SU1CH didn't get back from a furlough until the tests were half over. Even though late, Egypt was welcome to many who hadn't already worked SU1EC. There was a thrill to be found on about any kilocycle of the 14-mc. band during daylight hours. On 7 mc., particularly, the Kennelly Layer has never been more coöperative in holding down the American rock-crushers, allowing the foreign stations to wade through. On the last afternoon of the tests three Aussies were heard on 7 mc. poking their heads up well enough to add many more points to the already high scores.

After the contest there is the fun of comparing notes on foreign amateurs and scores. What were the results? During the melee everyone was so busy piling up scores that there was no time for discussion. At this moment we are not able to tell final results, and probably it will be a few months before all foreign logs have been received and a final story of the results can be written.

Until that time we are mentioning high scores in various American and Canadian districts as these stations have reported to us — which is to say, just a claimed score and not final.

The following stations report scores in excess of 5000. Scores listed were made by one operator.

W1BUX-10,764 W1CC-5915 W1CEG-7752  
W1CLX-7584 W1CMX-11,100 W1DHE-12,768  
W1DJX-10,989 W1DUK-6330 W1DXL-5425  
W1FTR-8085 W1GMS-6500 W1GSH-11,193  
W1IME-6318 W1QV-8466 W1SZ-29,172 \* W1ZB-6300  
W1ZI-22,412 W2AIW-5859 W2BHZ-19,147  
W2BPP-9690 W2BYP-14,268 W2CQX-14,147  
W2DC-19,194 W2ETM-5357 W2UK-14,400  
W3ZD-11,100 \* W3ZJ-33,200 W4AJX-22,570  
W4CBY-20,204 W4NN-7498 W5ATF-6318 W5BOW-5313  
W5MS-5586 W5UX-5736 W6ADP-7938  
W6BYB-11,691 W6CNX-6812 W6EXQ-16,044  
W6EYC-6600 W6FMU-6312 W6FYT-23,104  
W6HEX-6930 W6QD-19,198 W7BB-8129  
W7CFC-8352 W7DL-6350 W7VY-10,106  
W8ANQ-5874 W8AYO-6324 W8AZD-6240  
W8CRA-18,336 W8DWV-5735 W8NV-7350  
W8SI-5319 W8ZY-11,121 W9AEH-7632 W9CPQ-8874  
W9ELL-9450 W9GVR-5208 W9TB-7719  
CM1ML-6000 EA5BE-15,000 F8EB-7618 F8EX-7839  
G2MA-7500 HP1A-7667 K4KD-5070  
K4SA-11,124 K6COG-6591 NY1AB-25,648.

—C. C. R.

\* Station not competing.

## I. A. R. U. News

(Continued from page 95)

chairman, and Jean Mezger, f8GO, secretary, and they started work. By the second session they had unanimously agreed that there should be a Union, that it should have for its chief purposes the coördination and fostering of in-



# The Label Tells You!



When you buy a SPRAGUE TRANSMITTING CONDENSER you know exactly what you're getting. The label on every unit contains accurate but conservative ratings for type of circuit and rectifier tube with which it is designed to be used. No guesswork — no need to "play safe" by purchasing condensers of higher voltage than you actually require. Sprague's will help put your signals where you want 'em — the way you want 'em. And they'll stand the gaff!

Cat. No.	Capacity	Voltage	List Price
OT-11	1 mfd.	1000 V.	\$2.50
OT-21	2 mfd.	1000 V.	4.50
OT-22	2 mfd.	2000 V.	8.00
OT-41	4 mfd.	1000 V.	7.00

Made by one of the oldest, best-known manufacturers, Sprague Transmitting Condensers are the smallest size at the highest voltage. OIL IMPREGNATED AND OIL IMMERSED. Cylindrical windings — insulated terminals — ample safety factor. Sold today at the lowest prices in history. Clamps supplied FREE for easy mounting.

Write for the Sprague Condenser Catalog  
**SPRAGUE PRODUCTS CO.**  
 North Adams, Mass.



**TRANSMITTING CONDENSERS**

Unconditionally guaranteed against breakdown when used as specified

**Servicemen!** Write for FREE Tell-U-How Condenser Guide. Tells just what types of units to use and where. Saves you money — helps you do better work.

## University Course in RADIO COMMUNICATION

Open to high school graduates. Complete in nine months. High standard of instruction and equipment. Fall term opens September 14.

UNIVERSITY OF WISCONSIN — Extension Division  
 623 West State Street Milwaukee, Wisconsin

### PANELS — BAKELITE — RUBBER — ALUMINUM

All Sizes Cut to Order BAKELITE TUBING & RODS  
 Drilling, Engraving & Special Work  
 ALUMINUM CANS — Stock sizes. Special sizes, made to order.  
 ALUMINUM CHASSIS — Threaded brass studs for 6/32 screws.  
 Length from 1/2" to 6" — price 5c to 30c.

Insulating bushings for all size shafts  
 Bakelite Tubing Threaded to Specifications.  
 Couplings in brass or bakelite — 15c  
 Transmitting frames and racks.  
**UNITED RADIO MFG. CO.** Est. 1923 191 Greenwich St., New York

# BEN'S . . .

Ben's is moving to **10 BOYLSTON STREET, BOSTON.** Larger and better quarters for Amateur Radio Apparatus.

Complete stock of National sets and parts, Weston meters, RCA tubes — and everything else the ham needs at prices that will surprise you.

**Hundreds of specials. Let's go!**

Write in for your needs. Mail orders gladly filled.

**BEN**

# Help

**THE NEW ELECTRAD CATALOG** of Resistors, Volume Controls and Power Rheostats is brimful of helpful information — much of it of use in the **AMATEUR FIELD.**

A copy **FREE**  
**FOR THE ASKING**  
 Write Department Q-5



# WING

*We Specialize in  
EQUIPMENT for  
the Ultra High  
Frequencies*

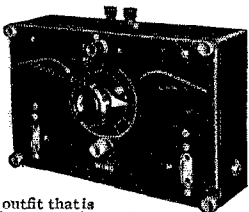

**FIRST** — A highly efficient transceiver which is gaining in favor everywhere. A real 5 meter job, strong, compact and highly serviceable, an outfit that is ideal for auto, aeroplane or other portable work. Has proven satisfactory in a large number of cases and will give performance only limited by topographical location.

The following features and many others sell the set on "sight": **CAST ALUMINUM BOX**, 6" x 9" x 2 1/4". Unit construction with all parts mounted on front panel, attractive finish in black wrinkle lacquer. Interchangeable coils up to 10 meters, adjustable antenna coupling coil, pi wound. Uses a 76 and 41 tube.

Transceiver with 5 meter coils, less tubes ..... \$16.50  
Tested and matched 76 and 41 tubes ..... 1.75  
Clamp for steering column of auto finished to match. 1.75

**SECOND** — A highly efficient antenna system for 5 meters, Picard type, outfit consists of matching transformer with sockets in either end for 2-46" brass rods. Transformer wound with one continuous piece of wire on impregnated wood form with bakelite cover. This system does not require tuned feeders and works well under all conditions. Many have commented on the efficiency of our outfit.

Matching transformer with 2-46" rods ..... \$2.50

**SPECIAL** — A collapsible model with telescoping rods, adjustable for exact frequency used, rods will telescope to 2' in length. .... \$3.95

**THIRD** — A 5 watt transmitter alone, for portable or permanent installations, police or other use. Class B modulation with 89 and 79 tube. Push-pull TWT circuit using 2-71A tubes. Also AC model. In cast aluminum case 10" x 13" x 3" thick. Finished in black wrinkle lacquer. Weston meter. Unit construction, all parts on front panel. Solid and strong. A real transmitter for many uses, frequencies up to 10 meters to order.

Price complete with tubes ..... \$60.00

**FOURTH** — Special transmitters to order for the ultra high frequencies. We have a 100 watt job specially for permanent installation. Prices on application, according to power, etc.

**CHAUNCKY WING'S SONS  
GREENFIELD, MASS.**

ternational amateur two-way communication, that it should be an organization by individual memberships until strong national societies had been formed in the principal nations and a federation would be feasible, and that its headquarters should be located in the U. S. A. Then a constitution was written, through a day and night session, with numerous delegates working until early morning preparing translations and copies.

By the morning of the 17th every delegate had a copy, and consideration began. By afternoon it had been examined section by section, and was approved by the entire Congress. The next act was the election of the bureau of officers. This was accomplished the morning of the 18th. Hiram Percy Maxim, u1AW, was elected international president; Gerald Marcuse, g2NM, international vice-president; Jean G. Mezger, f8GO, and Frank D. Bell, z4AA, councillors-at-large; and Kenneth B. Warner, u1EH, international secretary-treasurer.

Other sub-committees reported on such subjects as tests, wavelength distribution for international coordination, international auxiliary language, and calls and intermediates. The final plenary session, on the afternoon of the 18th, found a total of twenty-five nations represented: Argentina, Austria, Belgium, Brazil, Canada, Czecho-Slovakia, Denmark, France, Finland, Germany, Great Britain, Hungary, Italy, Japan, Luxembourg, Netherlands, Newfoundland, Poland, Spain, Sweden, Switzerland, Uruguay, the United States, and Russia and Indo-China, the two late arrivals.

As has been said, the first constitution provided for individual memberships in the Union. In each country from which there were twenty-five or more members, there was to be a National Section, with its own officers. For several years the Union flourished under this plan, national sections being formed in most of the principal nations of Europe and South America, with less numerous but representative organizations in the other continents.

But by 1928 it became apparent that the time had come to change the structure of the organization. In the ten countries where strong national bodies had sprung from the original national sections, separate individual membership in the Union was not only becoming increasingly difficult to stimulate, but was obviously a duplication of effort, and unnecessary; in the four countries where the original national sections had become inactive, individual membership was ineffectual and merely complicated the administrative machinery. It became increasingly obvious that the Union should be made a formal international federation of national societies.

On October 30, 1928, by an official vote of the existing national sections, a modified constitution was adopted. It made of the Union the international federation that was desired; no provision for dues or financing was made, but it was provided that one society would be chosen to act as the headquarters society, conduct all the affairs

## Get this big new Ham Catalog FREE

### 4-HOUR SERVICE

on all amateur, short-wave  
and replacement equipment

Including the following nationally known lines of dependable sets and parts:

NATIONAL  
HAMMARLUND  
RCA-DEFORST  
THORDARSON  
LYNCH  
WESTON

ACME-DELTA  
ELECTRAD  
CARDWELL  
BLILEY  
TRIPLETT

OHMITE  
JOHNSON  
AEROVOX  
BUD  
L.C.A.  
EBY

### Bargains by the thousands

**XXX Special** — THORDARSON I-3773, net \$1.95. Combination Plate and Filament Transformer. 550 volts each side c.t., at 140 m.a. Two 7.5 volt windings, each 2.5 amps. and 3 volts c.t. at 7 amps.

**210 TUBE**, 15-watts. Fully guaranteed with standard characteristics, net \$1.10.

**XXX Special** — THORDARSON I-2099, net \$1.49. Double section choke. 30 henries, 130 m.a. per section.

Write for New Catalog

## MID-WEST RADIO MART

520 S. State St. « Dept. Q » Chicago, U.S.A.

# The Radio Amateur's LICENSE MANUAL

(No. 9 in the series entitled The Radio Amateur's Library)

A necessity for the beginner — equally indispensable for the already licensed amateur. Going after your first ham "ticket"? You need the manual for its instructions on where to apply, how to go about it in the right way — and, most important of all, for the nearly 200 typical license exam questions and answers. Already got a license? The manual is still necessary — for its dope on renewal and modification procedure, the Class A exam (with questions and answers), portable procedure, etc.

All the dope on every phase of amateur licensing procedure, and, of course, the complete text of the new regulations and pertinent extracts from the basic radio law.

Order your copy today, 25c postpaid (no stamps, please)

**THE AMERICAN RADIO RELAY LEAGUE**  
WEST HARTFORD, CONNECTICUT

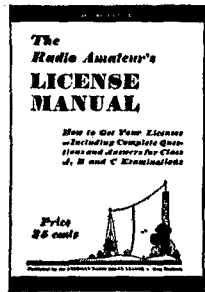

## CQ-AMATEURS of the West

Just off the Press, send for your copy

### 1934 CATALOG

All Nationally advertised parts  
for Transmitting and Receiving  
Lowest Prices

### RADIO SUPPLY CO.

H. A. DEMAREST, President

912-14 So. Broadway Los Angeles, Calif.  
(W6FBI, located in Building)

## HIGHEST QUALITY CRYSTALS

Made from the finest Brazilian quartz. Cut by modern optical methods. Parallelism of surfaces and their orientations with respect to crystallographic axes are held to better than .5 degree. "X" cut unless otherwise specified:

- 160-80 meter bands within 10.0 KC selected.... \$3.50
- 40 meter band within 10.0 KC selected.... 4.50
- 160-80 meter bands within 5.0 KC selected.... 4.50
- 40 meter band within 5.0 KC selected.... 5.50
- 160-80 meter bands within 0.5 KC selected.... 5.50
- 40 meter band within 0.5 KC selected.... 6.50
- Finished blanks for 160-80 or 40 meters..... 1.50
- 465-500-525 S.S. quartz filters..... 5.00
- 100 KC crystals..... 10.00
- 50 KC crystals..... 20.00

Broadcast-&-Commercial crystal prices upon request  
**BELLEFONTE RADIO ENG. LAB.**  
BELLEFONTE, PENNSYLVANIA

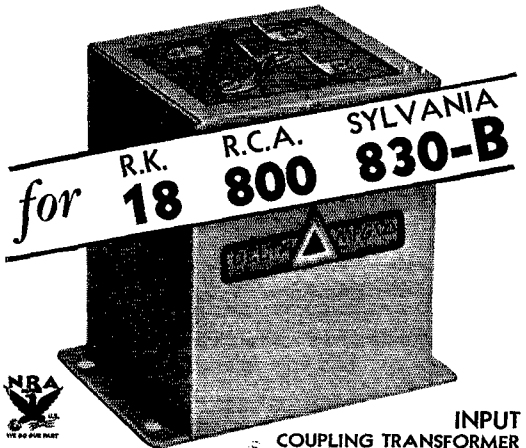

## ACME-DELTA COUPLING TRANSFORMERS

Delta now has available input coupling transformers for 2-2A3 push-pull into 2-R.K. 18, 2-800, or 2-830-B Class "B" grids, and the corresponding output units, from these tubes into Class "C" R.F. Input Transformers list at \$7.50 (AD-75 for R.K. 18, AD-77 for 800, AD-78 for 830-B), Class "B" Output Transformer AD-76 (for R.K. 18 or 800) \$15.50, and AD-79 (for 830-B) \$30.50. Prices subject to usual discount. Note new lower price for Input Transformer AD-78 for 830-B.

Good power supplies are required with Class B audio. Write for catalog Bulletin MQ-48-13.

F. S. Dellenbaugh, Jr.

Pres. & Chief Engr.



G. E. M. Bertram  
Treas. & Gen. Mgr.

# AT YOUR FINGERTIPS



## ALL

- ▶ developments in the high-frequency field
- ▶ transmitting and receiving circuits of interest to you
- ▶ regulations governing amateur radio communication
- ▶ good practical ideas of active amateurs

will be found in your file of *QST*, but — are yours in any semblance of order? Can you say that you can find information you need without a great deal of research? If you cannot, you need *QST* in BINDERS — properly indexed. You will find that they will more than pay for themselves. Single copies may be removed at will but because of the way that the binder opens (so that the copy is flat and easily read) there should seldom be a need to do this.

Each *QST* BINDER holds twelve issues of *QST* and the yearly index. It is a good-looking binder, sturdily constructed to not only keep your file in order but also to keep your copies in good condition. You will find it a good investment.

Priced at

**\$1.50 postpaid**

**AMERICAN RADIO RELAY LEAGUE**

West Hartford, Connecticut

of the Union, act as a medium for the carrying on of Union business, and that its officers would be the officers of the Union. The A.R.R.L. was chosen as the headquarters society, and has remained so to this day.

Those of the old national sections which had been active joined as national societies under the new constitution. Others were added to the roster. By the end of 1929 there were fourteen national member societies: the American Radio Relay League, Asociacion EAR, Associazione Radiotecnica Italiana, Canadian Section, A.R.R.L., Deutschen Amateur Sende und Empfangs Dienstes, Experimenterende Danske Radioamatorer, Nederlandsche Vereeniging voor Internationaal Radioamateurisme, New Zealand Association of Radio Transmitters, Norwegian Radio Relay League, Radio Society of Great Britain, Reseau Belge, Reseau Emetteurs Francais, South African Radio Relay League, and the Wireless Institute of Australia.

From this beginning, membership increased steadily until we now have the twenty-three member-societies listed in the I.A.R.U. News head—as many as were assembled at the original I.A.R.U. Congress, but with a considerably different roster. Membership requirements have been kept high, and only *bona fide* duly qualified amateur societies, thoroughly amateur in character and comprising the entire amateur radio of their respective nations, have been accepted into membership. Additional membership applications are now under consideration. The Union has grown greatly in strength and influence—so greatly, in fact, that it is now a recognized participant in the meetings of the International Technical Consulting Committee (C.C.I.R.), along with such bodies as the broadcasting union and the governments of the world.

Thus runs the story of the I.A.R.U. It is an impressive and a significant story, if a bit removed from the day-to-day operating practice of the amateur, or even his pursuit of international DX. That is why we deal more with such matters of commonplace practicability in this department, rather than with the purely administrative affairs of the Union itself. Yet let every amateur keep in mind that for ten years those in international high places have worked steadily, wisely, efficaciously, and silently, to preserve and maintain and improve his amateur radio. And they will continue to do so.

## Sweepstakes Contest Results

(Continued from page 98)

watts), W8JGN ('12A TPTG 2 watts), W4BMII ('01A 3 watts), W8HOS ('01As 180 v.), W9PJT (4 watts), W7BRU ('47s P.P. TNT-150 v.) Did some one say, "Where are the 'winning scores' you claim for low power?" OK, listen. W8BGY, Michigan leader (31,179), used only 35 watts input to final stage. W8GUF, Western Penna. leader (30,520), used '45s P.P. TNT, W4PL, Tennessee leader (22,002), used a '10 in final

# HERE'S HOW TO BECOME A RADIO AMATEUR

32 pages clearly written tell how to build the first receiver, a simple transmitter, an inexpensive monitor. You'll find a complete discussion of all the problems of the beginning amateur—all in 1934 style, up-to-the-minute and understandable—in "How to Become a Radio Amateur".

"How to Become a Radio Amateur" (No. 8 in the A.R.R.L. Series entitled "The Radio Amateur's Library") is the standard elementary guide for the would-be amateur. 25c (no stamps, please) postpaid anywhere.

THE AMERICAN RADIO RELAY LEAGUE  
WEST HARTFORD CONNECTICUT



**THE INSTRUCTOGRAPH**  
(Code Teacher)



The Scientific, easy and quick way to learn the code. Send a post card today for literature. Machines, tapes and complete instructions for sale or rent. Terms as low as \$2.00 per month. Rental may be applied on purchase price if desired. Rent for a month. If the instructograph meets every requirement, buy it. If not, send it back.

INSTRUCTOGRAPH CO., 912 Lakeside Place, Chicago

**RADIO ENGINEERING**

RCA Institutes offers a combined course of high standard embracing all phases of Radio. Practical training with modern equipment at New York and Chicago schools. Also specialized courses and Home Study Courses under new "No obligation" plan. Illustrated catalog on request



**RCA INSTITUTES, INC. Dept. ST-5**  
75 Varick St., New York. 1154 Merchandise Mart, Chicago  
Recognized Standard in Radio Instruction Since 1909

**IN STOCK**

NATIONAL  
FB7As ..... \$34.20 SW3s ..... \$17.70  
FBXAs ..... 47.70 Preselectors ..... 11.40

All National coils and power supplies in stock.

PATTERSON PR-10 ten tube Supers complete. .... \$70.25  
COMET PROS \$88.20, crystal \$23.52 extra, AVC \$17.64 extra.

**TRADE IN YOUR OLD RECEIVER ON THE LATEST MODEL IN STOCK:** 40% off National, Hammarlund, Patterson, Thordarson, Cardwell, Sprague, Universal Ward Leonard, Johnson, Trimu, Speed-X, Morrill; 33 1/4% off Triplett, Sylvania, Biley, Collins, Supreme all at list. Write for bulletins of any apparatus.

Every inquiry and order is personally attended to by Robert Henry, W9ARA, an active amateur for ten years; an E. E. from M.I.T.; and owner of Henry's Radio Shop selling amateur apparatus for six years. Your orders are appreciated and valued.

**HENRY'S RADIO SHOP**  
211-215 North Main Street Butler, Missouri

**NEW  
ULTRA-HIGH FREQUENCY  
PORTABLE COMBINATION**



**TRANSMITTER-RECEIVER  
NEW HIGHLY EFFICIENT CIRCUIT**

Many New Built-In Features

Tone Telegraph and Voice  
Sidetone in Phones on Transmission  
Rheostat, On-Off Switch, Reel Jacks  
Complete Instruction Book  
Uses One Type 30 and One Type 33  
Size 7 1/4" square, 5" deep. Weight 7 lbs.  
Black Wrinkle Finish

**PRICE \$17.40 net**  
At Your Nearest Dealer or Our Factory

**The HAIGIS LABORATORIES, INC.**  
MAPLE SHADE, N. J.  
Pioneers in the Ultra-High Frequency Field

# To Our Readers who are not A.R.R.L. members

**Y**OU should become a member of the League! That you are interested in amateur radio is shown by your reading of *QST*. From it you have gained a knowledge of the nature of the League and what it does, and you have read its purposes as set forth on the page opposite the editorial page of this issue. We should like to have you become a full-fledged member and add your strength to ours in the things we are undertaking for Amateur Radio. You will have *QST* delivered at your door each month. A convenient application form is printed below — clip it out and mail it today.

*A bona fide interest in amateur radio is the only essential qualification for membership*

AMERICAN RADIO RELAY LEAGUE  
West Hartford, Conn., U. S. A.

I hereby apply for membership in the American Radio Relay League, and enclose \$2.50 (\$3.00 outside of the United States and its Possessions, and Canada) in payment of one year's dues, \$1.25 of which is for a subscription to *QST* for the same period. Please begin my subscription with the ..... issue. Mail my Certificate of Membership and send *QST* to the following name and address.

.....

.....

.....

Do you know a friend who is also interested in Amateur Radio, whose name you might give us so we may send him a sample copy of *QST*?

.....

*Thanks*

stage. VE5HQ, British Columbia leader (21,518), used a pair of '10s in final. W9DMY, Nebraska leader (17,264), used a '10 in final. W9GWK, Wisconsin leader (26,376), used a '10 self excited. W9DMA, Southern Minn. leader (18,090), used two '10s. W9EMY, North Dakota leader (7878), used '46s P.P. final. W5PF, Southern Texas leader (10,912), used '45s P.P. TNT. W6ENM, San Francisco second-high (20,100), used only 50 watts input. W9EYH, Wisconsin second-high (22,950), used a '10 in final. W9GBJ, Missouri second-high (30,660), used a 65¢ '10 in final, and he worked 60 sections, too! W9AHR, Kansas second-high (21,168), used '45s P.P. in final. W8APQ, Western Penna. third-high (17,013), used a '45. W8BON, Ohio second-high (20,339), used a '10 Hartley. W3AKU, Eastern Penna. second-high (12,810), used only 40 watts input. W5CCW, Arkansas second-high (20,709), used a '10 TNT. W6FFP gave the San Joaquin gang a fast race (19,421) with his '10s P.P. TPTG and '10 Hartley rigs (description of W6FFP's outfit was in Oct. '33 *QST*). 35% of W1COL's contacts were made with 7 watts input on 3.5 mc., 15% with 25 watts on 3.5 mc., and 50% with 35 watts on 14, 7 and 3.5 mc. His score was 9360.

In addition to the special cases cited many other chaps using low and medium power made good scores. Among those in the single '45 (final stage) group: VE2DR, W8KNB, W7CQB; in the two '45s group: VE5EO, W4BOU, W1EWD, W1EOB, W7AGE, W9CGP, W8HWC; in the single '46 or '47 group: W1BSS, W8GGU; in the two '46s group: W8JVI, W8FYF; in the single '10 group: W8BYI, W1RY, W8LZS, W9BWV, W9EYL, W8BOF, W9FQQ, W4EF, W1EVJ, W2DMY, W6HZT, W3BYF, W8AXD, W9DFY, W5ADZ, W9KPN, W5CIJ, W5CEZ, W7AVB; in the two '10s group: VE5CA, W2AXZ, W2DYO, W2COK, W4BGA, W8ALG, W5DEJ. Just look up the scores of these operators!

The results of a few high scoring participants using power somewhat in excess of the "low" or "medium" class are interesting. W9GDH, Kansas leader and second-high nationally (61,842), used an '03A in final stage with 125 watts input. W9UM, Indiana leader and third-high nationally (50,700), used a 511 with 240 watts input. W4CA, E. Florida leader and fourth-high nationally (47,430), earned 30% of all points with a single '10 on 14 mc., 28% with two '52s on 7 mc., 17% with one '10 on 7 mc., 14% with two '52s on 14 mc., 6% with one '10 on 3.5 mc. and 5% with two '52s on 3.5 mc. W7AAT, Montana leader (17,640), used 130-150 watts input about 90% of the time, maximum power at any time being 270 watts. W1FH, Eastern Mass. leader and highest first district contestant (33,048), used 300 watts input to final. W9KEH, Illinois leader (25,760), used 100 watts input to 211D in final. VE5EC, British Columbia second-high (13,680), used a 211A c.c. on 3.5 mc., self excited on 14 mc. W9IFD, Colorado leader, used a pair of W.E. 205D's with 50 watts input, c.c. on 7 and 14 mc., self excited on 3.5 mc.

# You May Now Buy the Best Amateur Receivers and Transmitters on Our Deferred Payment Basis

WRITE FOR DETAILS, STATING YOUR NEEDS

**DELAWARE RADIO SALES CO.**  
405 DELAWARE AVE. WILMINGTON, DEL.

ATTENTION: WILLARD S. WILSON—W3DQ  
BRANCH OFFICE: 136 LIBERTY ST., N. Y. C.

# 10 YEARS IN RADIO TRANSMISSION

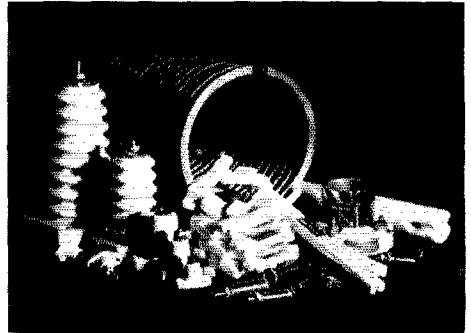

Like QST, we are proud of our years of service in the radio transmission field, for Johnson parts and prices fit everything from a single '10 ham rig to a 50 Kw. broadcast transmitter! Look for the JOHNSON label — it is a symbol of long experience, painstaking ORIGINAL engineering, skillful production and amazingly low cost.

## NEW! Johnson Type "D" Transmitting Condensers

At last — a REAL condenser for medium and high power stages! Dual-Section and regular models in a complete range of capacities and voltage ratings. Mycalex insulation, low losses, high flashover, heavier plates, better contacts, smaller mounting space and low cost are features of these superior, up-to-the-minute condensers. Ask your Johnson Distributor for Bulletin 200 or write us direct.

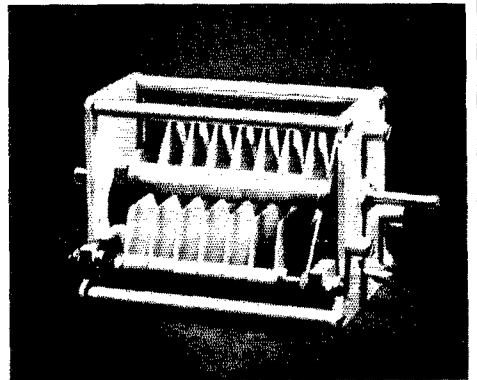

JOHNSON products include "stand-offs," transposition and antenna insulators, airplane insulators, feeder spreaders, tube sockets, plugs and jacks, transmitting condensers, inductors, clips and handwheels; Type "Q" Antenna System, 5-Meter antennas, doublet receiving antennas and doublet couplers. For all frequencies and all powers.

Stocked by Outstanding Parts Distributors Everywhere.

**The E. F. Johnson Company**  
Waseca, Minnesota, U. S. A.



## SANGAMO ACCURATE CONDENSERS

Available in 5000 volt construction  
for use in short wave transmitters

*Write for catalog sheet*

**SANGAMO ELECTRIC CO.**  
SPRINGFIELD, ILLINOIS

## Radio Operating Radio Servicing —



Prepare for the new Government Radio Operating license examinations; Radio Operator, Marine and Broadcasting. Also Radio Amateur Telegraph and Telephone. Resident courses.

*Write for Booklet*

**NEW YORK YMCA SCHOOLS**  
4 West 63rd Street, New York City

# TIME PAYMENTS

FOR THE AMATEUR  
ON

NATIONAL and HAMMARLUND

## Short Wave Sets

WRITE US TODAY FOR FULL PARTICULARS

64-Page Catalog furnished FREE upon request

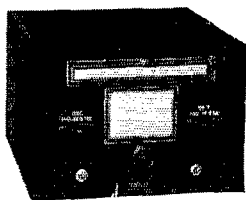

## INTER-STATE RADIO & SUPPLY COMPANY

1639 Tremont Pl.

Estab.  
1921

Denver, Colo

AMATEUR RADIO HEADQUARTERS IN THE  
ROCKY MOUNTAIN REGION

### SUMMARY

Little can be added to what has already been said about the 1933 Sweepstakes Contest but one thing which must not be overlooked is the fact that operation in this contest has proven without a question of doubt that a *good receiver* is an essential part of the present day amateur station. No longer is *transmitter power* the deciding factor in station accomplishment—*receiver sensitivity and selectivity* rates more consideration to-day. At the close of the SS more than one contestant felt that "the day of the super-het is here"; more than that, the need of a "single signal" job was strongly realized. W9UM puts it all in one sentence as follows: "A selective receiver, coupled with the proper amount of listening after each call, will result in QSOs, on highly congested bands with medium power, in spite of arguments to the contrary."

In closing this SS report we wish to point out that a report on the results of a contest of such proportions as the Sweepstakes, especially as pertains to use of frequency bands, power, etc., constitutes an actual picture of every day operating conditions—it is, in effect, a survey of what is being used, and how it's being used, in the amateur bands. We feel that whatever work the preparation of a complete report entails is fully justified on those grounds alone!

### NOTES ON SS PARTICIPATION

VO8Y didn't QSO his own Section, nor any Canadian section. W9DGT thinks the lads have the "R6-7" habit—he was R6-7 whether heard in the next block or in B.C. Hi. 90% of the stations worked at W8JIN had T9 signals. W8BYI'S receiver was 6 years old and he quickly realized it when fighting QRM on Saturdays and Sundays. W8LA'S QSOs averaged about ten minutes each. W9FLH worked 43 sections but failed to connect with Missouri, Indiana or Iowa, three sections bordering his—just one of those strange quirks of Lady Luck. W5ADZ worked stations at an average rate of one every twelve minutes. He points out how the "rest of the family" looks at ham contests:—"What a light bill we are going to have. . . . Don't you ever think of anything except radio. . . . Why do you always find so many contests to get into. . . ." and so far, far into the night! Upon asking one ham what section he was in W4PL got this answer: "South-west quarter of Sec. 3, Township 22, Range 6, West of the Basis Line, but what's it to you; you'd better lay off that home brew and go to bed." 85% of all stations worked by W5BUI said he was their first Mississippi QSO, and BUI couldn't work his own section. The SS came in and went out with a flood at W7TZ, handicapping him considerably since the power went off and he didn't care to run down the batteries on his TNT emergency rig working the contest; he didn't know just when he might be called upon to provide communication. Not a single CQ nor CQ SS was sent out at W2BAI; all QSOs resulted from answering CQs or calling other stations. As in the 1932 SS, W9DGS used no CQs. W6ENM found 3.5 mc. possibilities unbounded, working many east coast sections on that band; but he says "the first 1000 points are the hardest"—on any band. In the last hour of the fray W6HZZ made over 1000 points, one-fifth of his total. One fellow wanted to know what all the hissing was about (ss ss ss)—it was so bad at times one might have thought the villain was carrying off the fair damsel in episode six. Not all messages handled in the contest at W6TG were of the station-to-station type—he spent over a dollar delivering messages by telephone, including one death message. And then there was the fellow who thought every one was looking for stations with single signal receivers! After each QSO W4AVT sent "QRZ SS?"; he hooked five in a row after one QRZ? W8SS was W9BLZ'S last contest QSO. W3DNC worked W8DNC

## QST Oscillating Crystals

"SUPERIOR BY COMPARISON"

All "Scientific Radio Service Crystals" are accurately ground to an accuracy better than .03% on equipment tested regularly by the U. S. Bureau of Standards standard frequency signals.

### BROADCAST and COMMERCIAL BANDS

Broadcast Band Crystals mounted in our Standard Holder and ground to our usual high degree of accuracy now \$35.00 each. Mounted in our NEW Isolantite Monel Metal Crystal Holder \$45.00 (adjustable air gap). Prices for other Frequency Bands quoted upon application.

### AMATEUR BAND

Scientific Radio Service Crystals ground to within FIVE Kilo-cycles of your specified frequency in either 80 or 160 meter bands \$15.00 each. Mounted in our Standard Holder \$5.00 additional. Accurate calibration with each crystal.

PROMPT SHIPMENTS ASSURED

## Scientific Radio Service



"The Crystal Specialists" Since 1925

124 Jackson Ave., University Park

Hyattsville, Maryland Dept. Q-5



## Technical Training Station

Phone C. W.

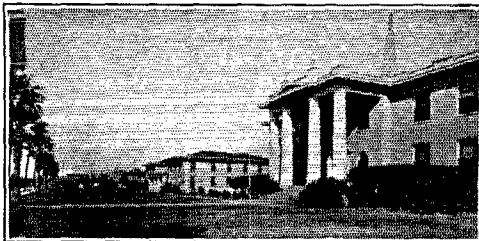

Studio Technique  
Guaranteed

**KFDM**

1000-Watt 560  
W. E. Kilocycles

**I**N 3 to 7 months we train you to secure Amateur, Commercial Telegraph Second-class, and Radiotelephone First-class government licenses. Course consists of Wireless Code, Radiophone, Microphone-Studio Technique, Television, Service, Police, and Aeronautical Radio. We are authorized to teach RCA Institutes, Inc., texts. At completion of your course you receive practical studio technique experience in broadcast studios located in our administration building, and operating experience on KFDM (1000-Watt W. E. Commercial Broadcast Station), and WPA, 4000-Watt Commercial Wireless Station. Return coupon for details.

## PORT ARTHUR COLLEGE

Port Arthur (world-known port) Texas

Name .....

Street or Box .....

City and State .....

## LOW RANGE FUSES

- *Littelfuses for Instruments:* Amps.: 1/100, 1/32, 1/16—20c ea. 1/8, 1/4, 3/8, 1/2—15c ea. 1, 2—10c ea. For milliammeters, ham rectifiers, etc. Use 1/8 for radio B circuits. *High Voltage Littelfuses:* 1000, 5000, 10,000 volt ranges in 1/16, 1/8, 1/4, 3/8, 1/2, 3/4, 1, 1 1/2, 2 amps. Renewable. Price 35c to \$1.25 ea. **NOW—\$100 PROTECTION GUARANTY.** Get New Cat. #5.
- **LITTELFUSE LABS.** 1784 Wilson Ave., Chicago

*"Quicker than a Short circuit!"* **LITTELFUSES**

## ONE REASON WHY



The **TRIMM FEATHERWEIGHT** phones will bring in weaker signals. The Trimm cobalt steel magnet when compared with the magnet of another well known and widely accepted phone on a demagnetizing test, showed but one half the percentage of loss in strength as the other magnet.

For better DX use Trimm Featherweight phones.

Buy from your local dealer

**TRIMM RADIO MFG. CO.**

1528 Armitage Ave.

Chicago, Ill.

## Fleron Insulators

Complete line of new sizes and shapes for Amateur use

**NEW FLERON-WALLACE ALL GLAZED** Transposition Block for S-W Doublet Antenna. List Price 20c ea.

**NEW FLERON-WALLACE S-W** Doublet Antenna outfit contains 200 ft. No. 14 Solid Enameled Copper Aerial Wire; 3 Tugite Glass Insulators; 20 Fleron-Wallace All Glazed Transposition Blocks; 2 No. 82 Terminal Insulators; 32-page Don Wallace S-W Instruction Book. List Price \$4.95. Catalog Q-655 Free.

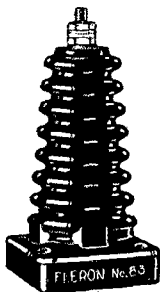

**M. M. Fleron & Son, Inc.** Trenton, N. J.

## THE NEW AND IMPROVED HARVEY TRANSCEIVER

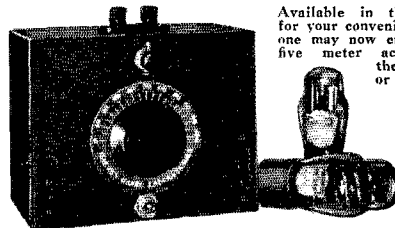

Available in three models for your convenience. Everyone may now enjoy summer five meter activity from their auto, plane or home.

1. 6-volt model, ideal for automobile and plane work .....\$17.95
2. 2-volt model for ultra portable use operating from the smallest batteries. (Also available in compact carrying case at additional cost) .....\$18.75
3. AC model for fixed use, employing our special power pack \$19.50 Special power supply for AC model .....\$14.00
4. Special Harvey matched impedance antenna system, Pickard type, including detachable aluminum antenna rods for portable 56 Mc. use .....\$2.25

Above prices do not include tubes or accessories

## THE HARVEY TRITET

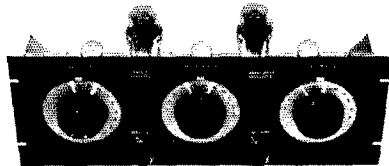

A universal exciter unit for 5 band operation. Constructed of heavy gauge aluminum and employing only nationally known parts of the highest grade. Complete with 2 Raytheon 59 tubes and three coils for any one band.....\$52.00

**THE COMPANION RK-18 AMPLIFIER** designed especially to follow The Tritet Universal Exciter Unit may be also used with the usual oscillator-doubler arrangement or wherever a highly efficient radio frequency amplifier is desired. Complete with tested RK-18 tube and coils for one band.....\$54.95

All prices are net F.O.B. Brookline and subject to change without notice. Write for literature on the above apparatus. Your inquiry will receive personal attention

## HARVEY RADIO LABORATORIES

12 Boylston Street, Brookline, Mass.

# HAVE YOU A COPY OF

A publication that gives you the opportunity of profiting by the experiences of others. Its eighty pages are chock-full of money-saving dodges and workable ideas that you will appreciate. Chosen from the thousands submitted, by the experimenters who have tried them, these ideas will give you the solution to many of your problems. Priced at 50c postpaid (no stamps, please), you won't regret having a copy on hand.

## HINTS & KINKS

for the Radio Amateur

A Symposium of the Selected Practical Money-Saving Ideas of 120 Experimenters

Price 50 cents



AMERICAN RADIO RELAY LEAGUE  
West Hartford, Conn.

—a thrill for them both! WIASY took time out of SS participation to work PA0AS on 3.5 mc. at 3:16 a.m. Dec. 17th. One station worked by WIBSF (J. D. Payne) had his initials for a call, W9JDP. W3LX wasn't in the contest but he thinks at least 90% of the active hams were—all he could hear was "CQ SS." W8DIG says 14 mc. went "solid SS" on Sunday, Dec. 9th. W3DPU put in 30 hours, 59 minutes of operating, averaging 2.13 points per minute and one section every 59.9 minutes. W8CO would like to know why antenna masts pick the middle of a contest to come down—his did it. W8FYF is satisfied—the only piece of gear he lost in the battle was a 2½ volt pilot light. Eight hours daily of Morse telegraphy didn't lessen W9DMY's itch for the ham key at night—at least not enough to keep him from winning Nebraska honors. When the SS closed W4AG swore he would never pound another key—but what ham could keep a resolution like that? W9AHR never took the contest so seriously that he couldn't find time to chew the rag; two QSOs lasted a full hour each (and look at his score!). Of W9FZO's 80-odd QSOs 53 were obtained on the two Sundays of the contest. W9EFK had a good time, but he blew 7 mikes of filter, one '10, lost a couple of neighbors' goodwill and the wife's good nature. Reasonable length CQs will pay dividends ninety-nine times out of one hundred—W4BG A backs up this statement by reporting QSOs with 23 stations on exactly 23 consecutive 3 x 3 CQs.

## Washington Notes

THE complete book of Federal Radio Commission Rules and Regulations has recently been revised and reprinted, and may be obtained for 30 cents (no stamps) from the Superintendent of Documents, Government Printing Office, Washington. The book is issued only in loose-leaf form, but the government does not sell binders. This book gives a fairly complete picture of the structure of radio administration in this country, and amateurs will find it valuable.

In our April editorial we mentioned that, although the F.R.C.'s monitoring program was aimed at coöperation and not persecution, some amateurs had been cited unjustly for non-d.c. plate supplies when they were in fact using d.c.; and we reported that A.R.R.L. had intervened and asked the Commission to modify its practices to insure justice. Complying with our request the Commission has now issued modified instructions to its monitoring stations, taking into account the possibility of apparent modulation in the transmission path. Our technical staff believes that the new instructions will prevent further injustices to amateurs.

Proposed new radio legislation in Congress, did you say? Yes, two lengthy bills to create a new Federal Communications Commission, and a third such bill promised. The League is watching the matter closely. Such new bills do not reallocate frequencies to services; they aim simply to modify the administrative set-up by transferring F.R.C. and the radio portion of I.C.C. lock, stock and barrel, regulations, personnel, equipment and funds, to a new combined commission. Fundamentally, from the amateur standpoint, then, such a move represents neither a danger to our frequencies nor an opportunity to expand them. The things that will concern us in such new legislation are that there shall be non-political administration, fair hearings, relief at law, and so on. A.R.R.L. is on the job.



**NEW** 

**354**

**GAMMATRON**

●

**A REAL**  
**Transmitting Tube**

**100 WATTS**  
**Rated Output**

*Write for Folder*

●

**HEINTZ & KAUFMAN LTD.**  
*Radio Engrs. and Mfrs. — SINCE 1919*

**311 California Street**  
**SAN FRANCISCO, Cal.**

**READ THIS LIST CAREFULLY—SAVE MONEY  
ORDER FROM ONE OF AMERICA'S LEADING RADIO  
PARTS COMPANIES. HERE ARE REAL LIVE VALUES!**

V.T. 203A.....	\$9.00	HyGrade Sylvania (15 Watt) 210.....	\$4.75
R.S. 830 (40 Watt).....	\$5.95	HyGrade Sylvania 830.....	8.75
		HyGrade Sylvania 203A.....	17.50
		HyGrade Sylvania 852.....	23.75

**TRIAD TUBES**

83.....	\$7.78
46.....	7.78
59.....	1.00

Four Discount 50%

R.C.A. 800.....	\$10.00
Raytheon 18.....	\$10.95
R.C.A. S.B. Hand Mike	\$1.19

**NATIONAL PARTS  
HAMMARLUND PARTS**

40% off

DeForest 450.....	\$9.99
-------------------	--------

**Valpey Crystals**

1750 KC-3500 KC 5%  
—\$2.25— X cut

**Crystal Holder**

with 80+40  
meter Electrode

\$1.25

**866's Guaranteed \$1.69**

Johnson 50 Watt Socket

\$1.20

**BALDWIN**

Type C Phones

\$2.50

Sickles 5 meter Kit—Tank, Choke, OSC... \$1.20

10 Watt Resistor any size..... \$1.19

1 MFD 1300 Volt.....	\$5.50
4 MFD 1300 Volt.....	2.50

Go-Devil Bug \$6.00  
American El. D. B. Mike. \$4.50

**CARDWELL CONDENSERS**

156 B—157B—123B—199T—  
147B—183—Full Line in Stock 40% off

**CHOKES**

30H. 40MA.....	\$5.50
30H. 100 MA.....	.89
30H. 150 MA.....	1.00
30H. 200 MA.....	2.50
20H. 200 MA.....	2.25
30H. 300 MA.....	7.40

2.5 Volt 10 amp.  
10,000 V. insul. \$2.75

**Tiny Mite Stand Off \$6.66**  
**Micro Mite Stand Off .05**

10 Volts 7 amps..... \$3.25

**SOLID ENAMELED ANTENNA WIRE**

No. 14. .49c No. 12. .69c No. 10. .89c per 100 Ft.

Readrite Mill. Meters..... \$5.99

**PLATE TRANSFORMERS**

600-0-600 — 150 Mills — 7.5 V. C.T. at 3 amps — 5 V. at 3 amps.....	\$5.50
600-0-600 — 2.5 C.T. at 3 amps — 5 V. at 3 amps.....	\$5.50
750-0-750 — 300 Mills — 7.5 C.T. at 3 amps — 5 V. at 3 amps.....	\$7.50
3000 C.T. — 2000 C.T. — 375 V.A.....	\$11.25
4000 C.T. — 3000 C.T. — 850 V.A.....	\$15.95

Class B Trans. per pair (40's) \$4.50

Jensen D 9..... \$4.50  
P. P. 45's 2500 .11 in.

Bliley xtals. \$3.90

1000 Mill R. F. Choke..... \$9.00

Johnson Q Ant. in Stock

MAIL ORDERS FILLED — INCLUDE POSTAGE — PROMPT SERVICE ON ALL ORDERS

**THE RADIO SHACK — 46 BRATTLE STREET — BOSTON, MASS.**

I'M AN OLD TIMER—  
THAT'S WHY I  
KNOW IT PAYS  
TO BUY AT THE  
**RADIO SHACK.**  
I'VE TRADED THERE  
FOR YEARS



**TRIPLETT METERS**

0-15 A.C. Volts	
0-50 D.C. Mills	
0-100 D.C. Mills	
0-150 D.C. Mills	
0-200 D.C. Mills	
0-300 D.C. Mills	

\$3.85

0-1 thermo couple \$6.66

0-2.5 thermo couple \$6.66

All in 3" Bakelite Case

**METAL-WORKING  
LATHE**

New designs and mass production methods make this amazing bar-lathe with compound slide-rest, improved three-jaw chucking device, 67" swing, 24" overall length, 20 lbs. Send postcard for catalog and 10-day trial offer, or save time and send \$1. balance plus express C.O.D. Wood-turning lathe \$4.50. Extra bed-lens, 60 per ft. Attachments for milling, grinding, sanding, saw-table, etc., available at low prices.



AMERICAN MACHINE & TOOL CO., Dept. Q 200 BROADWAY NEW YORK

**FOR FINICKY PEOPLE**

The Radio Amateur's Handbook in stiff Buckram covers \$2.00 postpaid  
**The American Radio Relay League, Inc.**  
West Hartford, Connecticut

**ORDER AT ONCE—AVOID THE RUSH**

Immediate delivery on the new two-stage all-wave

**PATTERSON PRESELECTOR**

Band change switch—no plug-in coils  
May be used with any receiver  
LIST PRICE \$30.00 COMPLETE WITH TUBES  
Subject to usual discount

**DELAWARE RADIO SALES CO.**

(Eastern Distributors)

405 Delaware Ave. Wilmington, Del.



**PYRANOL  
HEAVY DUTY  
X-MITTING UNITS**

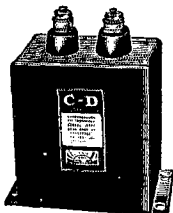

"Cornell-Dubilier Condensers are used by every modern broadcasting, commercial, and Government radio station throughout the world!"

CAT. NO.	CAP. MFD.	LIST PRICE	YOUR COST*
— Working Voltage 1,000 V. D.C. (750 V. Rect. A.C.) —			
TA-10010	1	\$4.50	\$2.70
TA-10020	2	6.75	4.05
TA-10040	4	11.25	6.75
— Working Voltage 1,500 V. D.C. (1,000 V. Rect. A.C.) —			
TA-15010	1	\$6.25	\$3.75
TA-15020	2	9.75	5.85
TA-15040	4	14.00	8.40
— Working Voltage 2,000 V. D.C. (1,500 V. Rect. A.C.) —			
TA-20010	1	\$11.50	\$6.90
TA-20020	2	13.50	8.10
TA-20040	4	16.75	10.05
— Working Voltage 3,000 V. D.C. (2,200 V. Rect. A.C.) —			
TC-30010	1	\$18.75	\$11.25
TC-30020	2	24.70	14.82
TC-30040	4	32.00	19.20

And — Dependable Condensers for Reliable Service up to 60,000 Volts!

\*Available at your supplier at above prices, less 2% cash discount.

NEW Catalog No. 126 now available from your supplier.

**CORNELL-DUBILIER CORPORATION**

**JOBBERS' DIVISION**



4373 Bronx Blvd. New York City

# HAM-ADS

(1) Advertising shall pertain to radio and shall be of nature of interest to radio amateurs or experimenters in their pursuit of the art.

(2) No display of any character will be accepted, nor can any special typographical arrangement, such as all or part capital letters be used which would tend to make one advertisement stand out from the others.

(3) The Ham-Ad rate is 15c per word, except as noted in paragraph (6) below.

(4) Remittance in full must accompany copy. No cash or contract discount or agency commission will be allowed.

(5) Closing date for Ham-Ads is the 25th of the second month preceding publication date.

(6) A special rate of 7c per word will apply to advertising which, in our judgment, is obviously non-commercial in nature and is placed and signed by a member of the American Radio Relay League. Thus, advertising of bona fide surplus equipment owned, used and for sale by an individual or apparatus offered for exchange or advertising inquiring for special equipment, if by a member of the American Radio Relay League takes the 7c rate. An attempt to deal in apparatus in quantity for profit, even if by an individual, is commercial and takes the 15c rate. Provisions of paragraph (1), (2), (4) and (5) apply to all advertising in this column regardless of which rate may apply.

Having made no investigation of the advertisers in the classified columns, the publishers of *QST* are unable to vouch for their integrity or for the grade or character of the products advertised.

OVER six pounds radio data, circuits, bulletins, 50¢ postpaid. Beyond Rockies 75¢. Kladag, Kent, Ohio.

MICROPHONE and meter repairs. Low prices. Quick service. Sound Engineering Corp., 416 N. Leavitt St., Chicago, Ill.

RADIO engineering, broadcasting, aviation and police radio, servicing, marine and Morse telegraphy taught thoroughly. All expenses low. Catalog free. Dodge's Institute, Byrd St., Valparaiso, Ind.

QUARTZ—Direct importers from Brazil of best quality pure quartz suitable for making piezo-electric crystals. Diamond Drill Carbon Co., 719 World Bldg., New York.

WANTED, meters, testing equipment, Weston, jewell, day-rad or supreme analyzer, tube tester, metal working tools and machinery, microscope, for cash or trade Xmitting apparatus & SW receiver (complete station) including wavemeters. F. G. Carr 75 Summer St., Lancaster, N. H. WICE.

QSLs, SWLs, W6DOU, Hayward, Calif.

QSLs! Snappy! Bright! Different! 200 two colors, \$1. Samples! Service! W5AUB, 410 Green, Tupelo, Miss.

CRYSTALS, 160-80 meter. Will trade for what have you? Uptown Radio, 1833 Elm St., Cincinnati, Ohio.

CRYSTALS, guaranteed, 160-80 meter, 3/4 to 1", within 15 kilocycles, plus or minus, \$1.35. 1", within 5 kilocycles, \$2.50. Hundred Kilocycle bar, \$5. c.o.d. William Threm, W8FN, 4021 Davis Ave., Cheviot, Ohio.

203A fifty watters, \$9.75 each. New, first quality and fully guaranteed. Also 211s and 845s. VTE Labs., Ridgefield, N. J.

QSL cards, two color, cartoons, message blanks, stationery, snappy service. Write for free samples to-day. W1BEF, 16 Stockbridge Ave., Lowell, Mass.

CALLBOOKS—new Spring 1934 Radio Amateur Call Book, many pages of new W calls added and hundreds of new DX stations, is yours for \$1.10. Next four issues for \$3.65 (Foreign \$1.20 and \$3.90). W9FO-610 S. Dearborn, Chicago.

CRYSTALS: 1" quality x cut, within 2-kc, \$2. Bliley BC2 holders, \$1.50. Monitor holders, 95¢. Crystal and holder, \$3.25-\$2.85. W8DLM, Rochester, Mich.

160 meter crystal controlled fone transmitter, complete, \$50. W8JOP, Wilkinsburg, Pa.

CRYSTALS inch square from Brazilian quartz power ground and accurately finished. Unconditionally guaranteed x cut plate, 80-160 meter 25-kc, \$1.50, 5-kc, \$2. Blanks, 65¢. Gentry Labs., 803 W. Maple, Independence, Mo.

SELL—National FBXA receiver and preselctor unit, also power pack and Jensen permanent magnet speaker in cabinet. General coverage and band spread coils all bands—preselctor coils B-C and all band spread. \$65. Harry Hicks, 2471 University Ave., New York.

HURRY hams get free catalog, complete transmitters and all supplies. General Engineering, Charlotte, Mich.

W8IU selling out fifty watt transmitting apparatus. Stamp for reply. Owen Barton, Ridgway, Penna.

QSLs! QSLs! SWLs! Guaranteed satisfaction! Stock unequalled! Buy Amateur, NRA. Samples? W4DED, Holland, Mich.

SELL National ACSW5 complete all bands, \$30. W2ERA.

HAMS notice! Large blueprints and complete constructional data on four different 5 meter phone transmitters and transceivers for only 85¢, postpaid. Results guaranteed. Order from Albert Freeman, South Hanson, Mass.

SELL Esco M-G set, 110v a.c. to 110v d.c. 400 watts, with field rheostat. Robt. Mezger, 4 Park Place, Troy, N. Y.

FOR sale—Silver Marshall short wave receiver 19 594 meters. Uses 2-24, 57, 2A5, 80. Write for description. F. M. Cotton, 1235 Trenton St., Seattle.

QSLs, two colors. Samples. Printer, Corwith, Iowa.

CRYSTALS: \$1.35 Hipower oscillators 1700-3500 Kc. bands, close to your specified frequency. 7000Kc. band \$4.25. Plug-in holder \$1.00 complete with mounting. Blanks 65¢. We supply crystals for any purpose. Write for bulletin. You cannot buy a better crystal than Hipower at any price. Immediate delivery. Hipower Crystal Co., 3607 N. Luna Ave., Chicago, Ill.

SELL Hammarlund Pro. August 1932. Sixty dollars. Robt. Mezger, W2BLL, 4 Park Place, Troy, N. Y.

GENERAL Electric 24/1500 volt Dynamotors \$35; 24/750 volt \$25. Westinghouse 27 1/2/350 volt \$10. Mounted pair \$15. 6-15 volt 500 watt Aircraft with propeller \$10. 500 cycle 500 watt with exciter 110-220 volts \$7.50. Dynamotors give pure DC outputs. Perfect results from battery plants. Crocker-Wheeler 25/275 volt generator, \$7.50. Henry Kienzie, 501 East 84th Street, New York.

TO Trade—1-Westor Photronic Relay (photo electric) new, 1-852 used, 1-860 used, 0-1 millimeters, 1-thermo coupled galvanometer, N E D Class B Transformers for 11-Ds input and output, other phone material. What hv u? W8LLE.

SELL 1932 Comet Pro all tubes, coils, excellent condition, \$35. Wayman, 1017 Grove St., Evanston, Ill.

WANTED—shortwave broadcast station verification cards. Obsolete types particularly desirable. Submit with lowest prices. W2GAU, 159 South St., Middletown, N. Y.

QSLs by Maleco. Finest in country. Free samples. Maleco, 1512 Eastern Parkway, Brooklyn, N. Y.

1000 watt transformers, General Electric, 1100-2200-4400 each side center. Mounted on marble, oilless, \$13.50. Dawson, 5740 Woodrow, Detroit, Mich.

HOW to make a filament transformer. Send dime to cover mailing. Sole "ham" agent for Morton high voltage mg sets. Hanson, 4832 Rice St., Chicago.

SHORT wave sets built from your parts or mine. Write for prices, ideas, etc. Satisfaction guaranteed. Virgil Darnell, Emerson, Ga.

SWAP: Unused Higher Accountancy Course for single signal receiver, transmitter.

SELL: Transmitter; choke; National .00045s; Radio Course. W8GLI, Fulton, New York.

WILL trade my Esco motorgenerator 600-1000-1500 volts, for a Comet Pro, FBX or similar receiver. Wm. Thomson, Congress St., Stamford, Conn.

QSL cards. Still printing them. Finest quality. Fair prices. W8CUX.

BROADCAST quality condenser microphone for your phone transmitter only \$25.00 net. Fully factory-assembled-and-tested-head (same head used Shure Model 40C Studio Type Condenser Microphone) and all essential parts (no case, chassis or cable) for two-stage head amplifier using '30 tubes. Kit includes factory-assembled head, two marked sockets, all necessary resistors, coupling and by-pass condensers, 200/50 ohm output transformer, wiring diagram and complete instructions. Fully guaranteed. Half cash with order, balance C. O. D. Shure Brothers Company, "Microphone Headquarters," 215 West Huron Street, Chicago, U. S. A.

SELL, slightly used, 552 \$14.00; Radiotron 852 \$14.00; Thordarson 2389A \$14.00; National 8000 volt, .00023 condenser \$5.00. Guaranteed OK. Harold Henry, Clarion, Iowa.

MAKE me an offer on 750 volt 227 mil. Esco motor-generator. Cost \$150. Will consider meters, transformers, chokes or what have you? Don Farrell, W8DSP, SCM-WNY, 213 Hickok Ave., Syracuse, N. Y.

COILS for FB7, band spread 20, 40, 80; also pre-r.f. complete with coils. Guaranteed perfect. First money order \$12. takes lot. W9QT.

BARGAIN dollar sale: Overstock 872s. One at \$17.50, two for \$18.50. Guaranteed. 410 S. Marengo, Alhambra, Calif.

SELL FBX-A, tubes, 40 meter coils, \$45. W2AWK.

212Ds trade for microscope, plate transformer, meters, gun, filter condensers, relays, receiver. W4AFK, Lawrenceburg, Tenn.

CRYSTALS: guaranteed excellent oscillators, 160 or 80 meters, your approximate frequency, \$1.35 postpaid. Crystal maker's blanks, 1", 65¢, dozen \$6. Irregular shapes, 25¢. Improved dust-proof bakelite holders, 1 1/2" silvered electrodes, increases efficiency, plugs into G.R. or tube socket mounting any position, no exposed electrodes. 75¢, dozen \$5.40. Fisher Lab., 4522 Norwood, San Diego, Calif. Formerly El Paso, Texas.

**CLASS B Transformers**—Universal for two or four 46's, 210's, 800's, KR18's, etc. \$7.75 pair. 70 watts of audio from 46's. Write for details and new Transformer Catalog. W8UD, Douglas, Michigan.

**SELL:** Collins 3A (03a amplifier unit) 20 and 40 meter coils. 6 mo. old. Power unit for 3A, 1200 volt double section 1000v. filaments. Both \$78. Acme AD21, AD31, 10. Esco 1000v. 200w. \$25. Thompson, 1301 Findlay Ave., New York City.

**FBXA**—80, 160 meter coils. One set each. \$4.50 set, both for \$8. Want used Teleplex. W. E. Arnold, 3665 Sutherland, Cleveland, Ohio.

**YOUR** call letters on a pin, lapel or vest. \$1.50. Satisfaction guaranteed. W2JU.

**TRADE** man's new gold wrist watch for FB7 or similar super-het, complete. W2CZR.

**WANTED**—Scott, Comet, National or similar either a.c. or d.c. Also p.a. equipment. Glenn Watt, Chanute, Kans.

**QSLs!** Real cards. Stamp for samples. W8DDS, 2155 West 81st St., Cleveland, Ohio.

**SELL**—crystal controlled transmitter complete, screened steel frame. 203A final \$75, 800v 200w MG set, \$20. Jewell 444 analyzer, \$40, generator 300v, \$8. W9CTW, Delano, Mich.

**XTAL** hundred watt station all—or part sell or trade for 54 Hornet and loading tools. W9CFO, Ulysses, Kans.

1000 watt transformer, 2000, 2500, 3000 each side. \$10. (ten). 1000 watt transformer, 800, 1100 each side, \$5 (five). W3CGA.

**TRANSFORMERS**—1 kw. 1000-2000-3000 each side \$22.75. Quotations given. Frank Greben, W9CES, Accurate Radio Service, 2920 W. Cermak Rd., Chicago, Ill. Phone Crawford 2050.

**WANTED**—old radio magazines, also engineering subjects. Write list and price. Jacques A. Kurtz, 100 E. 13th St., Brooklyn, N. Y.

**ESCO** motor generator, 1000 volt 300 watt perfect condition. \$50, plus freight. Ex W9ES, T. S. Cliff, 2700 College Ave., Terre Haute, Indiana.

**SELL, swap,** no radio parts. Westons, 301 type, 15 v.a.c., 3 rf. thermo-ammeter, 200 d.c. milliammeter. Lab type 476 3-15-150 v.d.c. Thos. A. Maras, 3537 33rd St., Long Island City, N. Y.

**CABINETS**—metal, chrome finish, 19x13x9 inches. Each \$1, plus \$5. Cash in advance. Gates Radio & Supply Co., Quincy, Ill.

**TRANSMITTING** tubes of all kinds repaired. New tube guarantee. Tubes returned c.o.d. New filaments, 203A, \$8, 852, \$11, 204A, \$30. Postage not included. Will quote on any type tube.

**COIL** calculation charts, 40c. W9AYY.

**WICHITA**. Kansas jobber stocking National, Hammarlund, Patterson, PR-10, Johnson, Hoyt, others. Free list, Lyon-Watt Radio.

**BEST** offer takes Gross Eagle receiver, tubes, bandsread coils. Clayton Wise, St. Marys, Penna.

**UNSCRAMBLE** telephone conversations with junk box parts. Diagram \$.50. W3VE, 330 Concord Avenue, Trenton, N. J.

**SELL** neat crystal controlled transmitter complete, \$30. Trade B flat soprano sax for transmitting tubes. W8ANO.

**TRANSMITTERS** engineered and manufactured. Your old transmitter rebuilt. Holmes C. Miller, Box 105, Palo Alto, Calif.

**QSLs, SWLs,** other ham printing. W3BHG, Baltimore, Md.

**QSLs!** Country's finest! W6FZQ, Box 1804, Phoenix, Arizona.

**QSLs!** 200 for \$1.00! Postpaid! Photograph QSLs! Samples free! W9ECL, Clayton, Mo.

**SALE**—1 short wave receiver, \$8.50; 1 a.c. d.c. converter, \$75. (500 watt). G. E. Rising, 149 W. 95th St., New York City.

**SELL**—Westinghouse motorgenerator, 750 volts at .28 amps with field rheostat, \$25; Eagle receiver with tubes, \$10; Teleplex with 4 tapes, \$10. All in good condition. W4AVX.

**KEYING** relays, \$2, postpaid. 6 volt direct current. Electrolarm, 500 Elm, Dallas, Tex.

**TRANSFORMERS**—400 Watt. 1250-1000-750-0-750-1000-1250. 300ma. Mounted. Terminal board. 7½x9¼x4 in. 32 lbs. \$7.50; 600-0-600, 300ma, \$5.00. Wanted silicon steel and NG transformers. Spear Company, Waterville, Ohio.

**FB7s, Teleplexes, Omnigraphs, Vibroplexes, receivers, meters.** Bought, sold, traded. Ryan Radio Co., Hannibal, Mo.

**PHOTOGRAPHIC QSLs!** Individual and original. Design your own cards with photographs or drawings. \$2.15 per hundred. Stamp for samples. W2FJE, 151 DeSalk Ave., Brooklyn, N. Y.

**CRYSTALS**—Guaranteed, one inch, eighty meters, X or Y, calibrated 1%, \$1.95 postpaid. Standard holders 75c. "Ham Crystals" W2DBQ, 1104 Lincoln Place, Brooklyn, New York.

**CRYSTALS** 1", x or y approximate frequency, guaranteed. Prompt service, \$1.35. W9HWE.

**VIBROPLEXES** new and rebuilt. \$8, up. Trade-ins accepted. Lydeard, 28 Circuit St., Roxbury, Mass.

**TAYLOR** tubes—866—\$1.65, 800, 845B, 203B—\$7.50, 825—\$4.95, 203A, 211—\$12.50. Ham receivers—Patterson, Sky-Rider, Sargent, others. Lowest prices—Transportation Allowance. Ross steel towers, vertical antennae, power equipment. Biley Crystals. Catalogs on all above. New monthly bulletin. L. I. Marine & Electric, 163-18 Jamaica Avenue, Jamaica, N. Y.

**SELL, swap.** 212Ds, sockets, transformers, C melody saxophone, ¼ hp., 3500 rpm. Westinghouse motor. Want: Good still camera, projector, movie camera. W2CE, Roosevelt, L. I.

**HEAVY** duty mesh filament 866s—\$2.50, 872s—\$7.50, 212Ds—\$10.00. Late type Universal S-C quarters \$15.00, 849s, 204As, etc. New diaphragms in W.E. mikes \$5.00. Ewing, 1057 Pratt Blvd., Chicago.

**DOUBLE** button mikes repaired. Complete overhauling, \$4.50. C. L. Clark, Wm. A. Whitbeck, 328 Atlantic St., Stamford, Conn.

866's—1000 hour guarantee \$1.49, filament transformer \$1.95, 203-A power transformer \$4.95. See March "Ham-ad". Lists. Howard Radio, 314 Pine Ave., Chicago.

**TRANSRECEIVER** 5 & 10 meter, \$13.75: Frequency meter April QST, \$16.50: Write for new catalogue. We build to order. Precision Radio Laboratories, 109 East 94 Street, Brooklyn, N. Y.

**WANTED, SW3** and coils. W8IDZ.

**CANADIAN** Hams Attention! 15 watt-210, \$1.98, 250, \$2.49, dome topped 866, \$3.89. ICA midget variables. Straight line frequency Isolantite insulation double bearings. 35 mmfd, \$1.12, 50 mmfd, \$1.29, 75 mmfd, \$1.57, 100 mmfd, \$1.77. ICA Isolantite coil forms 4 prong 42¢, 5 prong 47¢. Beede meters guaranteed accuracy 2%, moving coil. 0-1 mill 3¼", \$5.50, 0-5 to 0-1000 mill 3¼", \$4.50, 2¼", \$3.49. NaAid coil forms 4 and 5 prong, 25¢, 6 and 7 prong, 30¢. 6 tube power transformers 3¼"x4¼"x3", \$2.98, 3" and 5" magnetics, wonderful tone, \$1.85, 5" dynamics, 38 output, \$2.25, 6", 47 output, \$2.95. All merchandise guaranteed satisfactory or money refunded. Tubes subject to manufacturer's guarantee. A & A Radio Service Supply, 101 Queen Street, West, Toronto, Ontario.

**QSL** and SWL cards. Stamp for samples. W8ESN, 1827 Cone, Toledo, Ohio.

**WANTED**—FB7A, FBXA or Comet Pro. George R. Caron, 36 Hawkins St., Danielson, Conn.

**QSTs**, Feb. 1921 thru Aug. 1927, \$12. Express c.o.d. C. Tanner, 807 E. Oregon St., Urbana, Ill.

**CRYSTALS** 80-160 x cut 1" sq. within 3-kc. of frequency order, \$2. Ransom Lab., No. Syracuse, N. Y.

*"C'mup 'n' See me Sometime"*

*If You Can't Come, Write*

Whether you have a broadcast, short wave, automobile or all-wave receiver, you can get clearer, more realistic, noise-free radio reception by the use of the

**LYNCH**  
NOISE-FREE  
ANTENNA SYSTEM

It must outperform any other kind of aerial or so-called aerial eliminator, or it won't cost you a cent.

WRITE TODAY FOR FULL DETAILS

ARTHUR H. LYNCH, Inc.

51 Vesey St. New York, N.Y.

# Your Nearest Dealer

Your nearest dealer is entitled to your patronage. You can trust him. He is equipped with a knowledge and understanding of amateur radio. He is your logical and safe source of advice and counsel on what equipment

Patronize the dealer nearest you—

<p><b>ALLENTOWN, PENNSYLVANIA</b> Radio Electric Service Co. 1024 Hamilton Street Complete stocks transmitting equipment</p>	<p><b>CLEVELAND, OHIO</b> Radio Servicemen's Supply Co. 206 Prospect Street Wholesale Distributors catering to Amateurs, Dealers, Servicemen</p>
<p><b>BALTIMORE, MARYLAND</b> Radio Electric Service Co. 303 W. Baltimore Street Everything for the amateur</p>	<p><b>DENVER, COLORADO</b> Inter-State Radio &amp; Supply Co. 1639 Tremont Place Amateur Radio Headquarters in the Rocky Mountain Region</p>
<p><b>BOSTON, MASSACHUSETTS</b> Nutter &amp; Cross, Inc. 99A Milk Street All OMs, OWs, and YLs welcome — W1HRF</p>	<p><b>DETROIT, MICHIGAN</b> Radio Equipment Sales Co. 14036 Woodward Avenue, Highland Park A complete stock of amateur, shortwave and service parts</p>
<p><b>BROCKTON, MASSACHUSETTS</b> Ware Radio Supply Company 913 Centre Street Everything in parts. Comet Pro in stock with crystal filter</p>	<p><b>DETROIT, MICHIGAN</b> Radio Specialties Company 171 E. Jefferson Avenue Ham Supplies — National &amp; Hammarlund Sets and Parts</p>
<p><b>BUFFALO, NEW YORK</b> Dymac Radio 359 Capen Blvd. — Tel. Univ. 9380 Complete Stock Amateur Parts — Standard Discounts — W8AWK</p>	<p><b>ERIE, PENNSYLVANIA</b> Jordan Radio Laboratory 1019 East Fifth Street Amateur, service parts, including Bliley, National, Raytheon. W8CXG</p>
<p><b>BUFFALO, NEW YORK</b> Kronson Service Company 143 East Genesee Street Western New York's largest wholesale distributors — W8EHF</p>	<p><b>HARTFORD, CONNECTICUT</b> Radio Inspection Service Company 227 Asylum Street Yes, we'll take your old set in trade</p>
<p><b>CHICAGO, ILLINOIS</b> Chicago Radio Apparatus Company 415 South Dearborn Street  Dependable Radio Equipment. Established 1921. All Standard Lines</p>	<p><b>HOUSTON, TEXAS</b> Straus-Frank Company Distributors for nationally advertised amateur products RCA-DeForest transmitting tubes</p>
<p><b>CHICAGO, ILLINOIS</b> Mid-West Radio Mart 520 S. State Street All standard lines carried in stock</p>	<p><b>KANSAS CITY, MISSOURI</b> Burststein-Applebee Company 1012-14 McGee Street "Specialists" in supplies for the Amateur and Serviceman</p>
<p><b>CHICAGO, ILLINOIS</b> Newark Electric Company 226 W. Madison Street  Chicago's oldest radio parts store — established 1921 John T. Wallace, Technical Adviser</p>	<p><b>KANSAS CITY, MISSOURI</b> Radio Laboratories 1515 Grand Avenue Amateur Headquarters — Complete Stock — Quality Parts</p>
<p><b>CLEVELAND, OHIO</b> Northern Ohio Laboratories 2073 West 85 Street Wholesale Distr. for National, Hammarlund, Thordarson, Cardwell</p>	<p><b>LOS ANGELES, CALIFORNIA</b> Radio Manufacturers Supply Co., Inc. 1000 S. Broadway Amateur Headquarters of the Pacific Coast</p>
<p><b>CLEVELAND, OHIO</b> Northern Ohio Laboratories 2073 West 85 Street Wholesale Distr. for National, Hammarlund, Thordarson, Cardwell</p>	<p><b>MANCHESTER, NEW HAMPSHIRE</b> Radio Service Lab. of N. H. 1008 Elm Street — Tel. 218-W Branches — Portland, Me. and Barre, Vt.</p>
<p><b>CLEVELAND, OHIO</b> Northern Ohio Laboratories 2073 West 85 Street Wholesale Distr. for National, Hammarlund, Thordarson, Cardwell</p>	<p><b>MILWAUKEE, WISCONSIN</b> Radio Parts Company, Inc. 332 West State Street Complete stock Nationally Known products</p>

*This advertisement is paid for by the firms listed above. Qualified dealers*

# Is Your Best Friend

you should buy. His stock is complete. He can supply your needs without delay. His prices are fair and consistent with the high quality of the goods he carries. He is responsible to you and interested in you.

You can have confidence in him

## NEWARK, NEW JERSEY

Kaltman & Romander  
62 Court Street  
Drop in for an over-counter QSO

## PHILADELPHIA, PENNSYLVANIA

Freeland Radio Supply Co.  
5 N. 7th Street  
"If it's radio we have it"

## PHILADELPHIA, PENNSYLVANIA

Radio Electric Service Co., Inc.  
N. E. Cor. Seventh & Arch Sts.  
All nationally advertised lines in stock

## PHILADELPHIA, PENNSYLVANIA

Eugene G. Wile  
10 S. Tenth Street

Complete Stock of Quality Merchandise

## PITTSBURGH, PENNSYLVANIA

Cameradio Company  
603 Grant Street

Tri-State "Ham" Headquarters

Standard Apparatus

Standard Discounts

## PROVIDENCE, RHODE ISLAND

W. H. Edwards & Company  
32 Broadway, Room 23

Amateur Equipment — National, Hammarlund, RCA Tubes

## ST. LOUIS, MISSOURI

Walter Ashe Radio Company  
1100 Pine Street

W9FIS in charge of the oldest and largest parts store in St. Louis

## ST. PAUL, MINNESOTA

Lew Bonn Company  
2484 University Avenue

Rex L. Munger, W9LIP, Sales Engineer

Radio Wholesaler

Complete Stock

## SAN ANTONIO, TEXAS

Straus-Frank Company

Distributors for nationally advertised amateur products  
RCA-DeForest transmitting tubes

## SAN FRANCISCO, CALIFORNIA

Offenbach Electric Company, Ltd.

1452 Market Street

"The House of a Million Radio Parts"

## SHANGHAI, CHINA

Amateur's Home, Ltd.

323 Kiangse Road

Radio Manufacturer, Wholesaler and Retailer

## SPRINGFIELD, MASSACHUSETTS

T. F. Cushing

345 Worthington Street

An amateur, endeavoring to sell good parts

## SYRACUSE, NEW YORK

Roy C. Stage, W8IGF

Complete stock of standard Ham & BCL parts

Standard Discounts. Free technical service

## TORONTO, CANADA

A & A Radio Service Supply

101 Queen Street, West

We specialize in service! Try it!

## TORONTO, CANADA

Wholesale Radio Company, Limited

355 Danforth Avenue

Canada's Largest Amateur Supply House

## TRENTON, NEW JERSEY

American Radio Co.

5 N. Broad Street

Central Jersey's leading radio parts store

## WASHINGTON, D. C.

George's Radio Co.

816 F Street, N.W.

Washington's largest distributor of radio parts

## WILMINGTON, DELAWARE

Wilmington Electric Specialty Co., Inc.

405 Delaware Avenue

Amateur headquarters — Collins, Hammarlund, National, etc.

## ZANESVILLE, OHIO

Thompson Battery & Radio Service

393 West Main Street

Distributor radio equipment for amateurs and servicemen

are invited to apply for rates, etc., to Advertising Department, QST

Say You Saw It in QST — It Identifies You and Helps QST

# You Are Protected When You Buy From QST Advertisers

¶ "Advertising for QST is accepted only from firms who, in the publisher's opinion, are of established integrity and whose products secure the approval of the technical staff of the American Radio Relay League."

Quoted from QST's advertising rate card.

Every conceivable need of a radio amateur can be supplied by the advertisers in QST. And you will know the product has the approval of the League's technical staff.

For Your Convenience

## QST'S INDEX OF ADVERTISERS IN THIS ISSUE

Allen Bradley Company	144
American Machine & Tool Co.	137
Astatic Microphone Lab.	118
A.R.R.L. Application Blank	132
Binders	130
Bookshelf	117
Emblem	126
Handbook	137, <i>Con. 17</i>
Hints and Kinks	136
How to Become	131
License Manual	129
Supplies	115
Bellefonte Radio Engineering Labs.	129
Ben's	127
Birnback Electric Co.	125
Blan, The Radio Man, Inc.	125
Billey Piezo-Electric Co.	105
Burgess Battery Company	4
Cameradio Company	121
Candler System Company	122
Capitol Radio Engineering Institute	125
Cardwell Mfg. Corp., Allen D.	1
Central Radio Labs	110
Cornell-Dubilier Corp.	137
Delaware Radio Sales Co.	133, 137
Delta Mfg. Company	129
Electrad, Inc.	127
Emery, A. H.	123
Fleron & Son, Inc., M. M.	135
General Electric Co.	143
General Radio Company	120
Gross Radio Company	99, 109
Gulf Radio School	121
Hais Labs	131
Hammarlund Mfg. Co.	6, 7
Harvey Radio Labs	135
Heintz & Kaufman	136
Henry's Radio Shop	131
Hygrade Sylvania Corp.	98, 100, 102, 104, 106, 108
Instructograph Co.	131
Inter-State Radio & Supply Co.	134
International Resistance Co.	124
Johnson Co., E. F.	133
Kaltman & Romander	116
Kenyon Transformer Co.	113
Leeds	101, 103
Littelfuse Labs.	135
Lynch Mfg. Co.	139
M & H Sporting Goods Co.	123
Massachusetts Radio School	119
Midwest Radio Mart	128
McGraw Hill Book Co.	112
National Company	97, 111, <i>Con. 111</i>
New York YMCA School	133
Port Arthur College	135
Precision Piezo Service	121
RCA Institutes, Inc.	131
RCA Radiotron Co., Inc.	<i>Con. 17</i>
RCA Victor Co., Inc.	114
Radio Manufacturing Engineers	119
Radio Shack	137
Radio Supply Company	129
Raytheon Production Corp.	119
Rectifier Engineering Service	121
Ross & Co., A. H.	123
Sangamo Electric Co.	133
Schwartz & Son, Maurice	118
Scientific Radio Service	134
Sprague Sales Co.	127
Telenex Company	119
Thordarson Electric Mfg. Co.	107
Trimm Radio Mfg. Co.	135
United Radio Mfg. Co.	127
Universal Microphone Lab.	125
University of Wisconsin	127
Westinghouse Electric & Mfg.	2
Wing's Sons, Chauncey	128



# SINGLE CONTROL

## FOR AMATEUR PHONE SHORT-WAVE STANDARD BROADCASTS

You'll enjoy the simplicity with which the new G-E short-wave sets can be used. There is only one tuning control and no coils to change.

In the all-wave models two tuned R. F. stages on the 8-18 megacycle band eliminate image frequency response. On the other bands one stage is used. Frequency range on 4-band all-wave models:

- (A) 540-1500 KC (B) 1500-3900 KC  
(C) 3900-10000 KC (D) 8000-18000 KC

On 2-band dual-wave models:

- (A) 450-1500 KC (B) 5400-15350 KC

Accurate tuning is assured by the airplane-type illuminated dial accurately graduated in kilocycles and megacycles. Short-wave broadcast ranges are marked on the dial in meters.

You can safely recommend these G-E short-wave sets to your non-technical friends. Their performance is good and they are easy to operate.

With these sets, and a simple, single-tube oscillator, you can receive continuous wave. Diagrams of the oscillator and instructions for making it will be sent upon request.

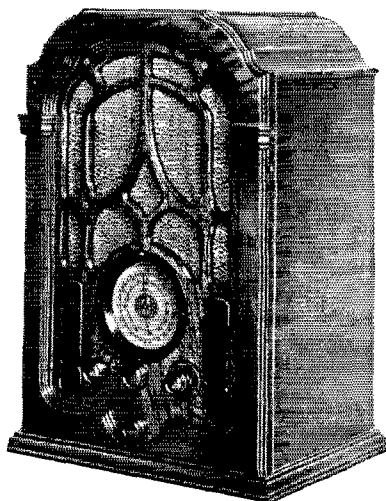

All-wave Model K-80. Price \$92.50

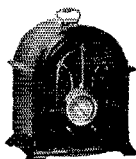

Dual-wave  
Model K-64  
Price \$58.50



Dual-wave  
Model M-65  
Price \$79.50



All-wave  
Model K-85  
Price \$128.75

*Price slightly higher West and South. Subject to change without notice.*

Radio Sales Section R-675  
GENERAL ELECTRIC COMPANY  
Merchandise Department  
Bridgeport, Conn.

Please send me free of charge: diagram and instructions on C. W. oscillator.

Name \_\_\_\_\_

Street \_\_\_\_\_

City \_\_\_\_\_ State \_\_\_\_\_

# GENERAL ELECTRIC RADIO



# A. C. RELAYS

Made by

## Allen-Bradley

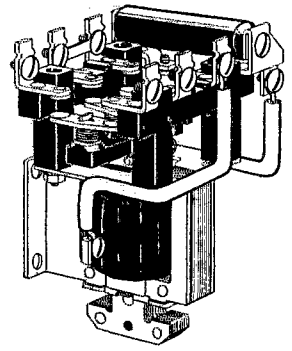
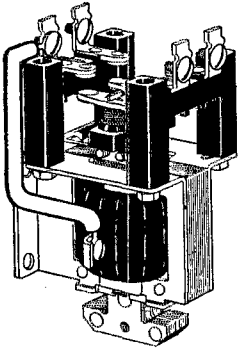

These A. C. solenoid relays are ideal for remote control of transmitters, for control of crystal ovens, and for any general remote control application except for keying. THESE RELAYS WILL NOT OPERATE IN KEYING SERVICE. Silver-to-silver double break contacts are used throughout.

The maximum contact rating is 10 amperes at 220 volts. The relay coils are wound for 115 volts 60 cycle alternating current. Relays for other voltages can be supplied on special order. Use coupon below when ordering.

Type No.	Poles	Nor- mally	Circuit Diagram	Price		Type No.	Poles	Nor- mally	Circuit Diagram	Price	
				Open	In Cab.					Open	In Cab.
A107	1	Open		\$3.00	\$4.00	A177	1	Closed		\$5.00	\$6.00
A117	1	Closed		3.00	4.00	A207	2	Open		3.50	4.50
A127	1	Open and Closed		3.50	4.50	A217	2	Closed		3.50	4.50
A137	1	Open		3.50	4.50	A227	2	Open and Closed		4.50	5.50
A147	1	Closed		3.50	4.50	A237	2	Open		4.00	5.00
A157	1	Open and Closed		4.00	5.00	A247	2	Closed		4.00	5.00
A167	1	Open		5.00	6.00	<p><b>Radiostat</b>—A stepless graphite compression rheostat for primary of 550 watt filament or plate supply transformer. Range 4 to 150 ohms. <b>Price \$6.50</b></p>					

### ORDER BLANK—MAIL WITH REMITTANCE TO

Allen-Bradley Co., 108 W. Greenfield Ave., Milwaukee, Wis.

Enclosed find money order for \$-----for which please send me, shipping charges prepaid, the following items:

Name .....

Address .....

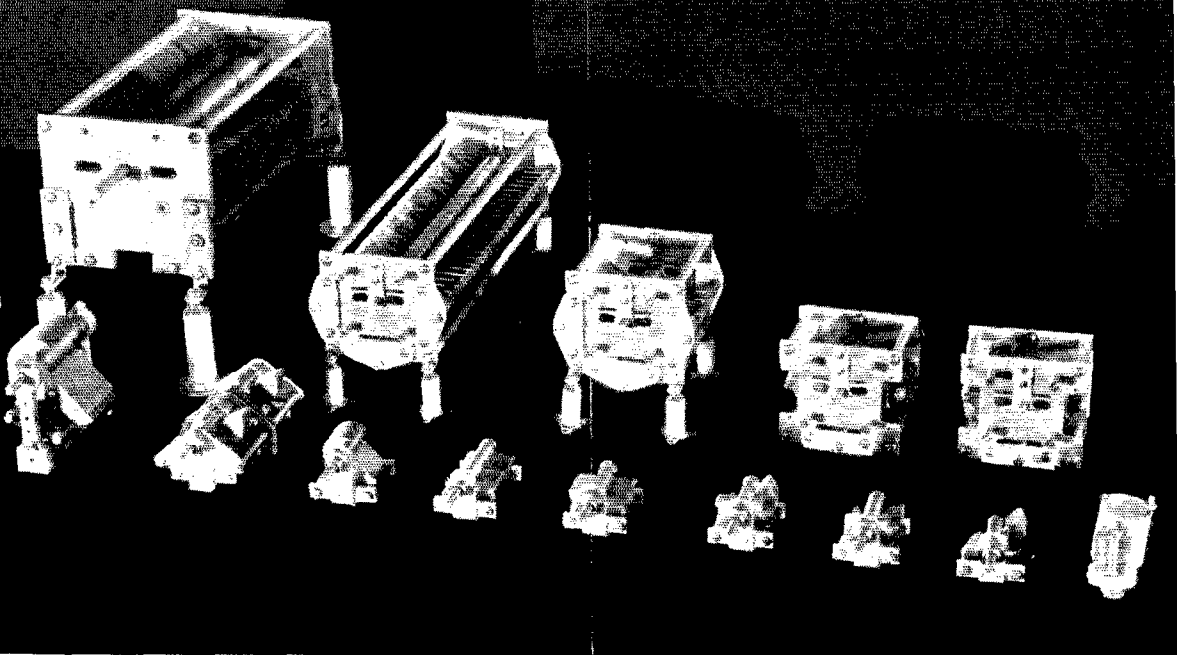

**HANDSOME IS AS HANDSOME DOES •** Quality in technical equipment means more than surface finish, it implies a particular fitness for the task, an unusual efficiency in operation, a ruggedness to endure. Such quality we claim for National Condensers • Each unit from the midget padding condenser, remarkable for its strikingly low temperature coefficient, to the heavy Navy type with high volt-ampere rating, displays this particular fitness. Alike in the careful use of low-loss insulation, non-resonant plates and trouble free rotor connections, they possess this unusual efficiency. And painstaking design, good materials and nice craftsmanship insure lifetime reliability.

NATIONAL



COMPANY

# HINDSIGHT and FORESIGHT

★ It isn't often that we are able to reminisce, but on the occasion of A. R. R. L.'s 20th Anniversary, let's shut down the rig for a couple of minutes, start up the pipe, and think back over what has happened to radio, particularly radio tubes, in the last twenty years. ★ Lots of us like to say, "Give me the good old days." Let's think it over. For instance, did any of you old-timers ever hold a match under one of those baseless, double-filament, double-ended, so-called receiving tubes in an effort to improve its sensitivity? Did you ever try to raise the lad next door with 1 kw. of ear-splitting, misdirected and unradiated spark energy, only to discover that he could hear your "rotary" by the sound-wave route better than he could by the radio route? Did you ever try to make a receiver sit up and do tricks with tubes whose characteristics wandered clear off the curve sheet during the course of adjustments? Did you ever try to make one of those new-fangled tube transmitters justify the investment while the tubes were going as soft as butter under a hot sun because of the plate voltage you thought they could stand? ★ Well, old-timer, would you like to swap some of the good old headaches listed above for one of the new supers which cut through QRM like a knife? Or how about some of the real he-man apparatus that is now available to amateurs? We now have transmitters which squirt out all of their energy, and at the frequency you want, too. We have seen tubes developed to the point where they are really apparatus of laboratory precision. And we have seen a lot of young lads grow up to be operators capable of putting some of the old-timers to shame. Come to think of it, maybe things aren't so bad now, after all. ★ We of the RCA Radiotron Company are proud that we have had a part in the development of amateur radio to its present high plane of technical excellence. Tireless and far-reaching research in RCA laboratories has made possible tubes of unequalled quality and uniformity, and, as a direct result, transmitters and receivers of vastly improved performance. If the past can be used to predict the future, you may count on the RCA Radiotron Laboratories for still greater contributions to radio technique.

★ **E. T. CUNNINGHAM, *President*** ★  
**RCA RADIOTRON COMPANY, INC.** ★

★ C A M D E N, N E W J E R S E Y ★  
★ A Radio Corporation of America Subsidiary ★